

Solutions Catalog

Arbitrary Waveform Generator Unit U8793 and Memory HiCorder Combining Generator and Memory Functions

Memory HiCorders make testing and experimentation convenient.

Combine generating and recording functions



10 mHz to 100 kHz

Output Frequency Range (Function Generator Mode)

2 MHz Max.

D/A refresh rate (Arbitrary Waveform Mode)

Generate and record at the same time with the same instrument

Combining a Memory HiCorder and the Arbitrary Waveform Generator Unit U8793 gives you a function generator mode, arbitrary waveform generator mode, and waveform measurement mode in a single unit.

This makes it easy to observe waveforms while varying test conditions, such as changing the signal's amplitude and frequency as well as programming various waveforms to output in order.

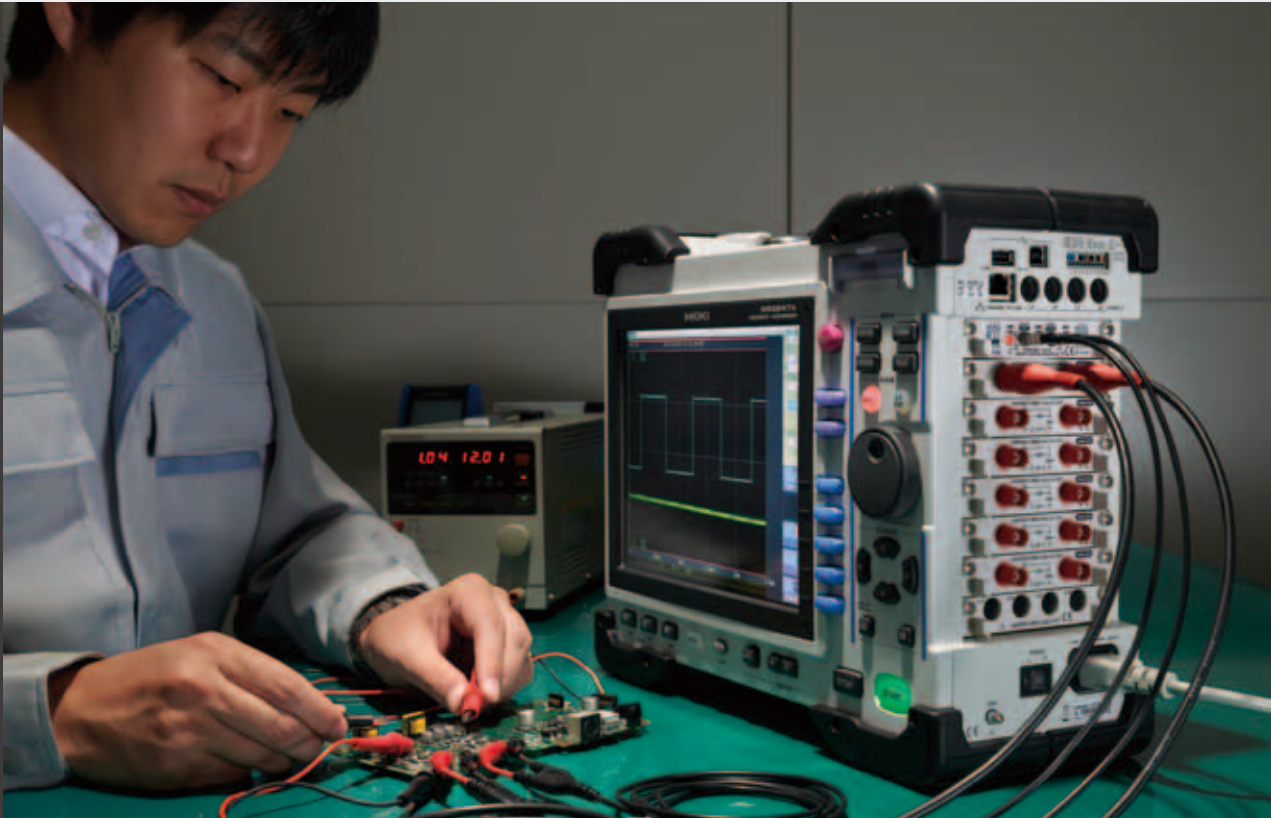

Example applications

Observe waveforms while varying the output conditions to a circuit board

Conventional procedure

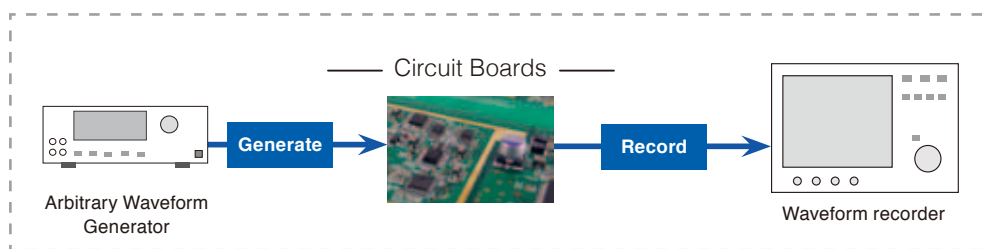

Voltage inputs only



MR8847A + U8793

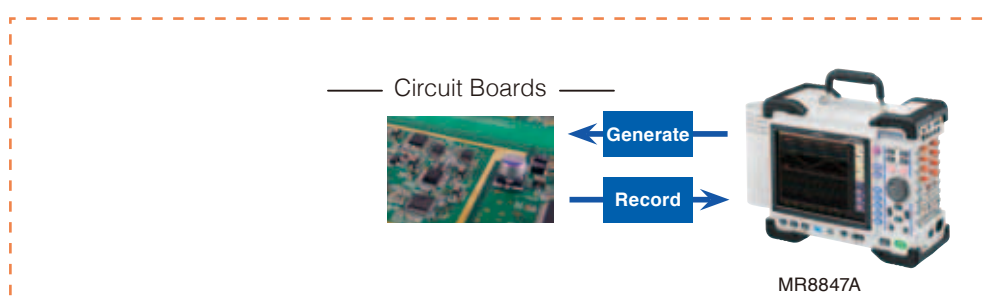

Arbitrary Waveform Generator Unit U8793 installed



Output recorded waveforms without modification

The combination of a Memory HiCorder and the Arbitrary Waveform Generator Unit U8793 lets you output actual waveforms captured from a test vehicle without modification for later use in standalone testing. What's more, the U8793 can generate isolated output of up to 15 V without a generator or amplifier, as well as meet traditional requirements for generating output while varying the signal's amplitude and frequency.

Example applications

Testing of electronic control boards for automobiles

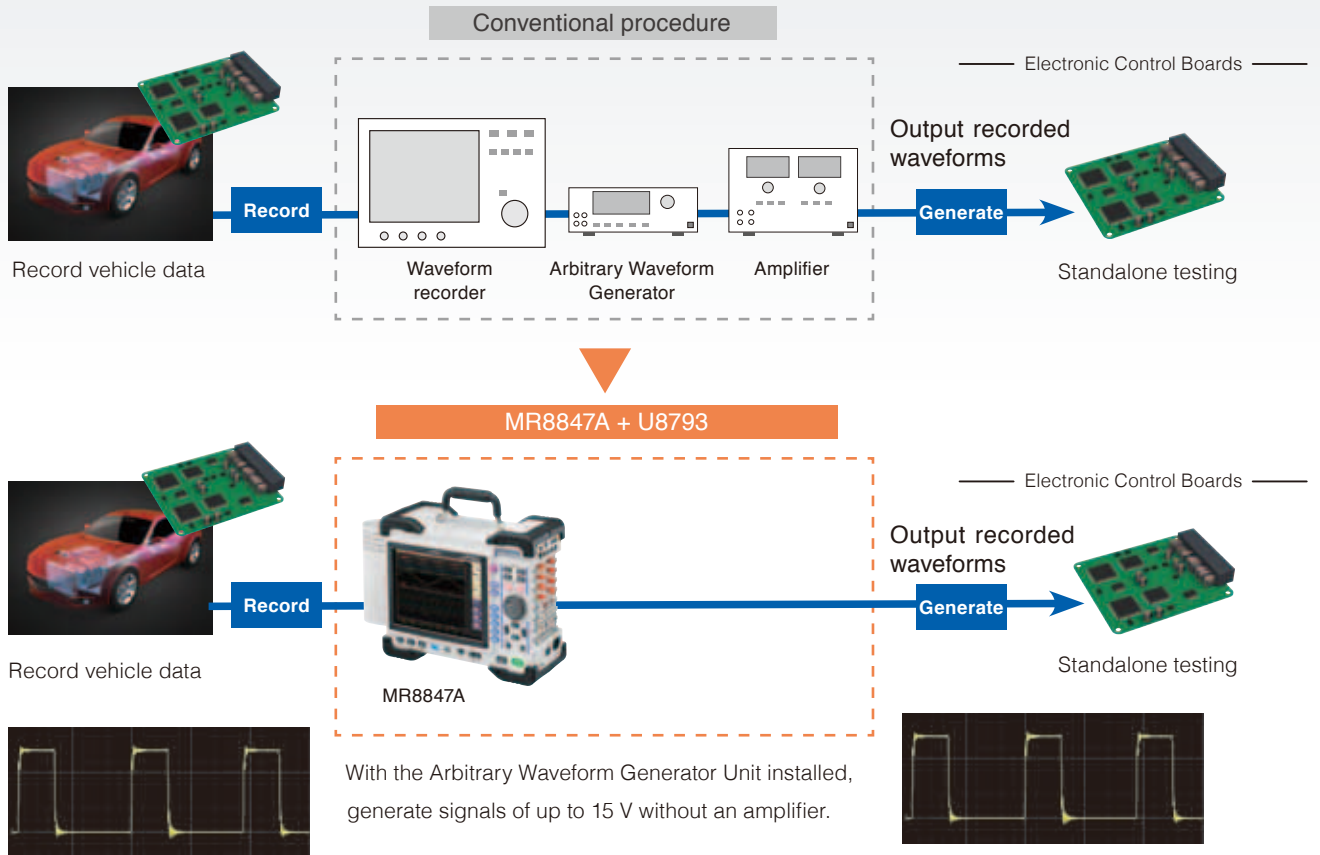

15V Max. output range

Without connecting an amplifier externally, you can **directly apply** a signal simulating output from automobile sensors.

Avoid amplifier noise

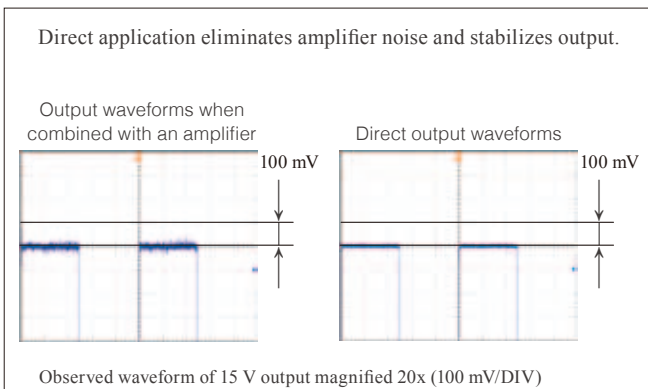

Process actual waveforms for reproducibility testing

Use the Waveform Maker SF8000 to reproduce signals recorded with the Memory HiCorder and perform calculations and processing to create and output an arbitrary waveform.

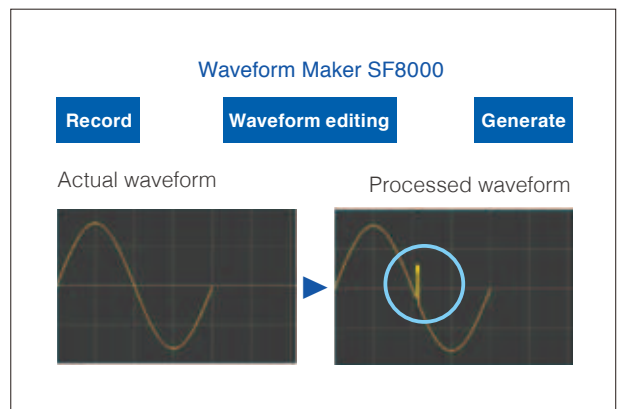

Easy settings to improve efficiency

Efficient generation of recorded measurement data is important. Registering waveforms on the Memory HiCorder makes it easy to configure the generator output. You can also use program settings on the Memory HiCorder to output a variety of patterns.

Waveform registration

Repeated generation of recorded waveforms

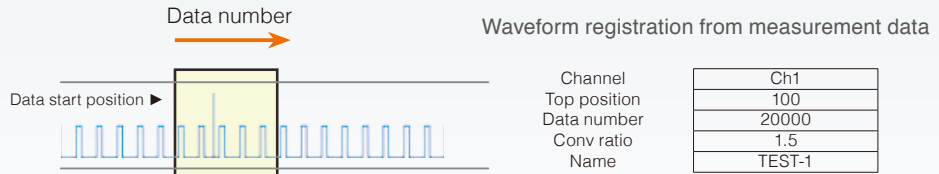

Register waveforms by "clipping" the desired signal from the measurement data

Generate registered waveforms "as is"

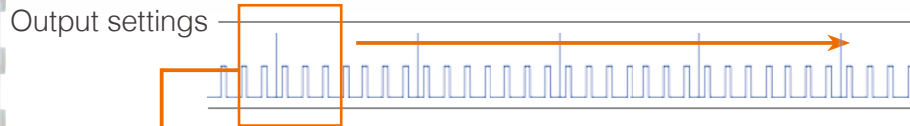

Set the data name for the arbitrary waveform that you registered and the number of loops to be generated

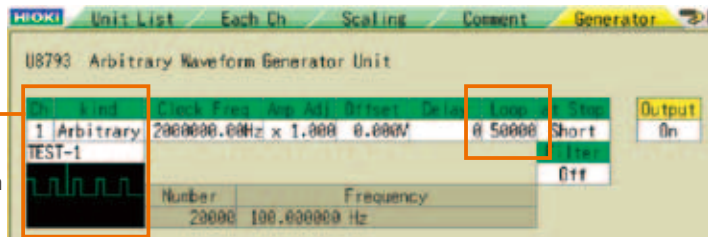

Registered waveform (sample image)

Program

Link together to generate a variety of waveforms

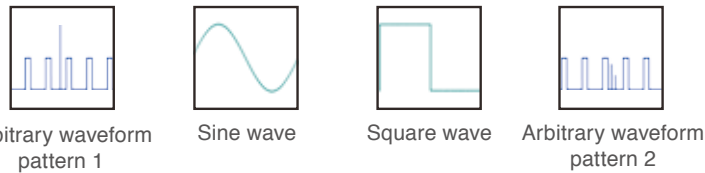

Step	Kind	Frequency	Amplitude	Offset	Delay	Phase	Time	Loop	Hold
1	Arbitrary	10000.00Hz	x 1.000	0.000V	Number		1s	Off	
2	Pattern1	1000.00Hz	10.000Vpp	0.000V		0.0°	1s	Off	
3	Square	1000.00Hz	10.000Vpp	5.000V		0.0°	1s	Off	
4	Arbitrary	10000.00Hz	x 1.000	0.000V	Number		500ms	Off	
	Pattern2						2000 20.000000ms		

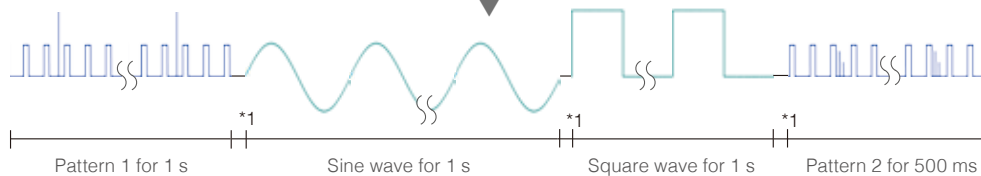

*1. Approximately 20 μs is required for the switch between each step.

Output settings

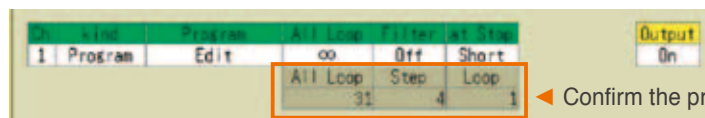

Confirm the progress of the current step.

Synchronize output or independently control across all channels

Create phase settings between channels in the same unit and between different units.

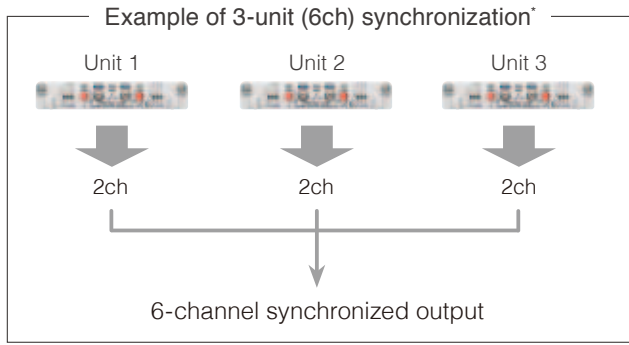

* The maximum number of channels varies according to the Memory HiCorder.

If the sequence loop has a hold setting, you can release the hold with an external input signal. There are independent control terminals for each channel, allowing you to control each channel at an output timing with arbitrary time lags.

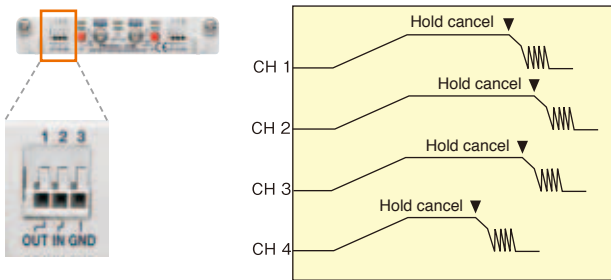

The MR8790 Waveform Generator Unit and the MR8791 Pulse Generator Unit do not have phase control or synchronize control modes.

Waveform Maker SF8000

Installing the bundled Waveform Maker SF8000 on your computer lets you enter waveforms or enter functions to easily create waveforms. You can also process actual waveforms to quickly add noise and multiply waveforms.

* This software (including the Instruction Manual in PDF) is on the Application Disk included with the Memory HiCorder.

● Waveform creation

Waveform input	Input from file: Memory HiCorder MR8847A, MR8847, 8847, MR8827, MR8740, and MR8741 Power Quality Analyzer PW3198 CSV (format for Memory HiCorder and this application) Input with basic waveform: sine wave, pulse wave, triangular wave, ramp wave, SIN (X)/X wave, EXP wave, noise, DC Input with drawing tool: free curve, straight line
Function input	14 function types: ABS (absolute value), SIN (sine), COS (cosine), DIFF (differential), INTG (integration), CINT (integer), EXT (index), LOG (natural logarithm), NRND (random number), SQUR (square root), RMPD (ramp down), RMPU (ramp up), TRI (triangular wave), INV (inverted) 7 control words: AREA, END, FOR, NEXT, PERIOD, PI, STEP, T, TO, V
Step input	Set and input a waveform for each step. Select basic waveform: sine wave, square wave, triangular wave, ramp wave, noise, DC
Readable file formats	Waveform creation software: SF8000 (FGW), 7990 (WFG) Arbitrary waveform generator: 7075 (WFG) Memory HiCorder: MR8847A, MR8847, 8847, MR8827, MR8740, and MR8741 (MEM) Power Quality Analyzer: PW3198 (EVT), CSV
Edit entered waveforms	Cut, copy, paste, clear
Calculate entered waveforms	Add, subtract, multiply, normalize, change size, absolute value, invert, mirror
Waveform display	Enlarge, reduce, scroll, TIME/DIV display, V/DIV display, Point display (time axis, voltage axis), % display (voltage axis)

● Pulse pattern creation

Input	Use editor to input, and select range and edit, including copy, paste, and delete
Readable file formats	SF8000 (PLS), CSV
Save file formats	SF8000 (PLS), CSV

Max. 54 channel generation/isolated output



Modulization of waveform generation capabilities allows output from 2 channels up to a maximum of 54 channels.*

You can expand channels without connecting cables between devices.

*The maximum number of channels varies according to the Memory HiCorder.

Isolation between the Memory HiCorder and each output channel and between the channels enables connections with devices that have different potentials.

Multi-channel output Memory HiCorder

Please refer to the catalog for each Memory HiCorder model for detailed specifications.

MR8827 Max. 32 ch	MR8740 Max. 54 ch
MR8847A Max. 16 ch	MR8741 Max. 16 ch
There are three MR8847A models with different memory capacities.	
MR8847-51: 64MW MR8847-52: 256MW MR8847-53: 512MW	
NEW	

The Memory HiCorder by itself cannot create arbitrary waveforms. Use the Waveform Maker SF8000.

Process actual waveforms

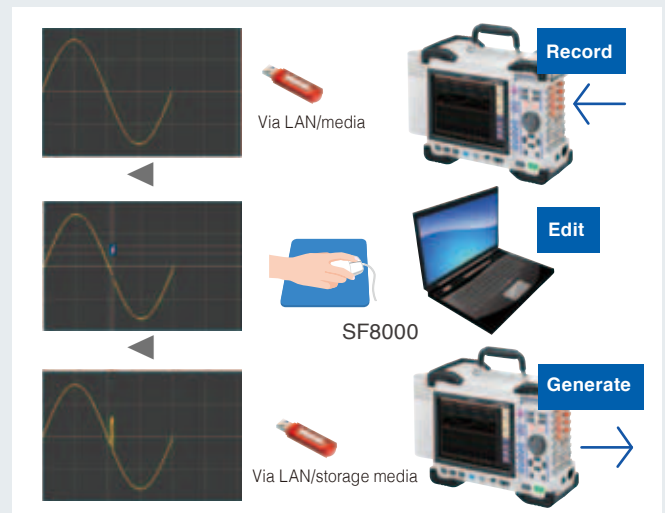

● Operating environment

OS	Windows7 (32bit/64bit)/Windows8.1 (32bit/64bit)
Memory capacity	1GB RAM or more (32bit), 2GB RAM or more (64bit)
Hard disk	10 MB or more free space

● Interface

Interface	LAN
Arbitrary waveforms	Select a Unit No. and Channel No. for the Memory HiCorder to transfer arbitrary waveform data.
Pulse patterns	Select a Unit No. and pattern for the Memory HiCorder to transfer data.

Applications

Automobile and railroad (transport equipment) testing

Use actual waveforms to test control boards for engine control, airbags, brake systems, power steering, active suspension, and more. Make efficient use of actual waveforms obtained from the vehicle when using a Memory HiCorder.



Record actual waveforms

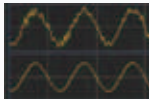

Vehicle sensor signals such as torque, rotational speed, pressure, and acceleration



Voltage output

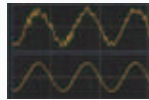

Vehicle sensor inspection

Inspect sensors in automobiles. Use the Memory HiCorder and arbitrary waveform generator unit to generate pulse signals to input to sensors, and then record the signals that those sensors output in return. You can even set the generation voltage to 14 V to simulate a car battery.

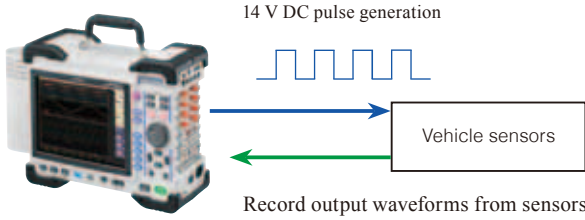

Power steering endurance test

Create power steering operation signals for each pattern. Endurance testing has never been conducted so efficiently.



Vibration reproducibility testing

Use vibration waveforms recorded in the field with the Memory HiCorder for vibration testing. Efficient reproduction testing at the press of a button.

Vibration testing equipment



Record actual waveforms

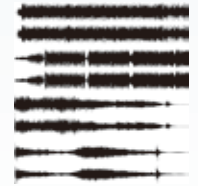

Inverter motor performance test

Create and evaluate VVVF control evaluations and PWM waveforms for inverter motors, air conditioning, lighting equipment, power supplies, and more.

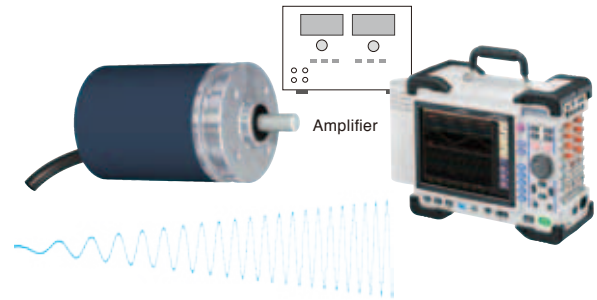

Power anomaly simulation

Create power supply waveforms such as power supply dips, instantaneous interruptions, and voltage fluctuations for immunity tests to regulate malfunctions in equipment caused by power supply harmonics, and load the actual waveforms obtained with the Power Quality Analyzer PW3198 to perform evaluation testing.

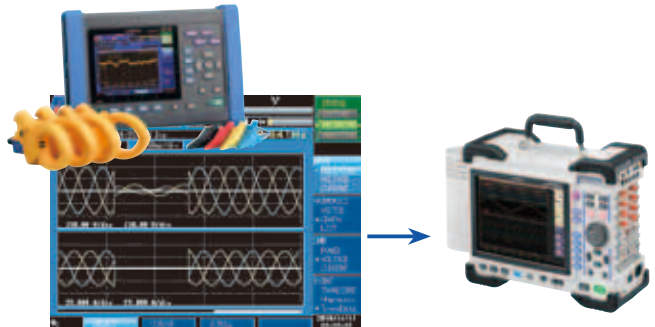

Output waveforms (examples)

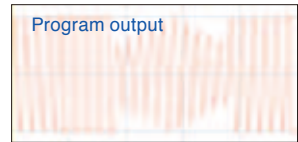
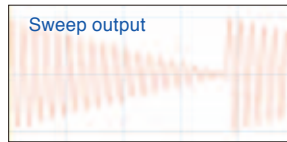
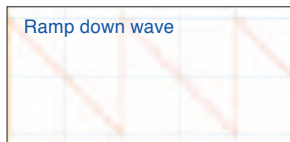
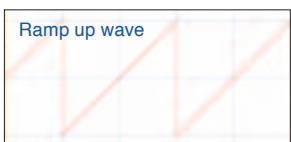
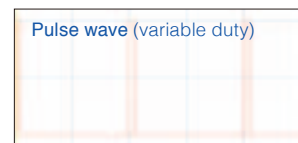
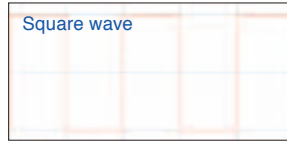
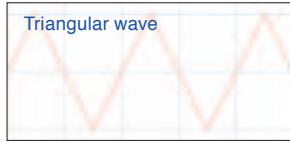
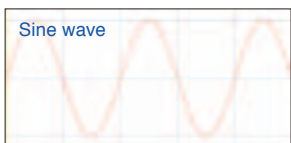

Arbitrary Waveform Generator Unit U8793

New
feature



CAUTION: Although you can use MR8847 waveform data for output, you can only use the MR8847A for waveform generation.

Specifications Accuracy guaranteed for 1 year;
Post-adjustment accuracy guaranteed for 1 year

Common specifications

Accuracy guarantee conditions	Temperature and humidity at which accuracy is guaranteed: 23°C ±5°C (73°F ±9°F) and 80% rh or less Warm-up time: 30 minutes or more Power supply frequency for Memory HiCorder connected to U8793: 50 Hz/60 Hz ±2 Hz
Number of output channels	2 channels per unit
Output terminal	SMB terminal
Output type	Unbalanced output (floating)
Maximum rated voltage to ground	33 V AC rms or 70 V DC (Between each output channel and the main unit, between the channels and external I/O terminals, and between the output channels) Expected transient overvoltage: 330 V
Maximum output voltage	-10 V to 15 V
Amplitude setting range	0 V to 20 V p-p (setting resolution: 1 mV)
DC offset setting range	-10 V to 15 V (setting resolution: 1 mV)
Output impedance	1 Ω or less
Max. output current	±10 mA (per channel)
Allowable load resistance	1.5 kΩ or more
Output type	Waveform output, open, shorted

FG functional specifications

Output waveforms	Sine wave, square wave, pulse wave(duty ratio variable), triangular wave, ramp wave, DC
Output frequency range	0 Hz to 100 kHz (setting resolution: 10 mHz)
Output frequency accuracy	± 0.015% of setting
DC output accuracy	± 0.05% of setting ± 10 mV
DC output temperature characteristics	(± 0.005% of setting ± 1 mV)/°C
Amplitude accuracy	± 0.5% of setting ± 10 mVp-p (10 mHz to 10 kHz) ± 0.8% of setting ± 10 mVp-p (more than 10 kHz to 50 kHz) ± 1.0% of setting ± 10 mVp-p (more than 50 kHz to 100 kHz)
Amplitude temperature characteristics	(± 0.05% of setting ± 1 mVp-p)/°C
DC offset accuracy	± 0.5% of setting ± 10 mV
DC offset temperature characteristics	(± 0.05% of setting ± 1 mV)/°C
Phase difference setting range	-360° to 360° (setting resolution: 0.1°)
Jitter	Within 50 ns p-p (square wave, pulse wave, triangular wave, ramp wave)
Pulse wave duty setting range	0.1% to 99.9% (setting resolution: 0.1%) Enabled for a pulse width of 500 ns or more
Pulse wave duty accuracy	Period ±0.1% (10 mHz to 5 kHz) Period ±0.5% (more than 5 kHz to 20 kHz) Period ±1.0% (more than 20 kHz to 100 kHz)

Arbitrary waveform generation specifications

Output waveforms	Waveforms measured with Memory HiCorder MR8847A, MR8847, 8847, MR8827, MR8740, and MR8741 Waveforms created with Waveform Maker SF8000 Waveforms saved with Waveform Generator 7075*1 Waveforms measured with Power Quality Analyzer PW3198*1 Waveforms created as CSV-format files*1 *Logic waveforms are not supported.
Voltage axis resolution	16 bits
Waveform memory capacity	256 kW/ch. × 8 blocks
Low-pass filter	2-stage LPF, 50 Hz to 1 MHz (14 steps in 1-2-5 progression)
D/A refresh rate	Max. 2 MHz (setting resolution: 10 mHz)
Clock frequency accuracy	±150 ppm (Clock frequency jitter: within 50 ns p-p)
Delay	-250.000 to 250.000 (Setting is possible in units of 1 data point.)
Number of loops	1 to 50000 times, or ∞

*1. Prior conversion using the Waveform Maker SF8000 application software is required.

Model : ARBITRARY WAVEFORM GENERATOR UNIT U8793

Model No. (Order Code) (Note)

U8793

(For the MR8847A or other)

Options

CONNECTION CABLE L9795-01

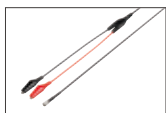

Maximum rated voltage to ground:
33 V AC rms or 70 V DC
SMB terminal - alligator clip
Cord length: 1.5 m (4.92 ft)

CONNECTION CABLE L9795-02

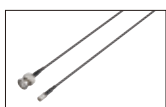

Maximum rated voltage to ground:
33 V AC rms or 70 V DC
SMB terminal - BNC terminal
Cord length: 1.5 m (4.92 ft)

Sweep function specifications

Sweep waveforms	Non-DC function generation waveforms and arbitrary waveforms
Sweep form	Linear
Sweep targets	FG waveforms: Frequency, amplitude, offset, duty (pulse waves only) (Frequency, amplitude, and offset can be swept at the same time.) Arbitrary waveforms: Clock frequency, amplitude, offset (Clock frequency, amplitude, and offset can be swept at the same time.)
Sweep time setting range	10 μs to 1000 s (setting resolution: 10 μs)

Program specifications

Sequence length	Max. 128 steps linked for output
Step control	FG waveforms, sweep waveforms, and arbitrary waveforms can be set for each step. Number of loops (sweep waveforms) and output time (FG waveforms, arbitrary waveforms) can be set for each step.
Hold settings	On/Off can be set for each step.
Output time setting range	10 μs to 1000 s (FG waveform, arbitrary waveform)
Number of step loops setting range	1 to 1000 times (sweep waveform)
Number of total loops setting range	1 to 50000 times, or ∞
Monitor functions	Display step number, number of step loops, and total number of loops while the program is running.

Other specifications

Channel synchronization	Set phase between unit channels or between units
Self-test function	Monitor output voltage values Monitor resolution: 10 mV Monitor accuracy: ±3.0% f.s. (F.s.=15 V)
Output start/stop	Key operation of Memory HiCorder and signals to external control terminal
External input	When using program functions, use an external low-level signal input to release the hold and move to the next step. Control voltage level: 3.5 V to 5.0 V (HIGH level), 0 V to 0.8 V (LOW level) Response pulse width: 100 μs or more (LOW level)
External output	Output when waveform is output Output format: Open drain output (active low, with 5V voltage output) Output voltage level: 4.0 V to 5.0 V (HIGH level) 0 V to 0.5 V (LOW level), Max. On/Off capacity: 5 V to 30 V DC, 50 mA
External I/O terminal	Push-button terminal block
Waveform output display	Red LED On when waveform is output, and Off when output is OFF.

General specifications

Operating temperature and humidity range	According to the Memory HiCorder installed with the U8793
Operating environment	According to the Memory HiCorder installed with the U8793
Storage temperature and humidity	Temperature: -20°C to 50°C (-4°F to 122°F), Humidity: 80% rh or less (no condensation)
Standard compliance	Safety: EN61010 EMC: EN61326
Dielectric withstand voltage	350 V AC (sensed current: 1 mA) (Between each output channel and the main unit, between the channels and external I/O terminals, and between the output channels)
Dimensions and mass	Approx. 106 mm (4.17 in) W × 19.8 mm (0.78 in) H × 196.5 mm (7.74 in) D, approx. 250 g (8.8 oz)

The operation manual is included in the "Application Disk", bundled with the Memory HiCorder.

Set example (Generation: 8ch, Input: 8ch)

MEMORY HiCORDER	MR8847-51	1 unit
ARBITRARY WAVEFORM GENERATOR UNIT	U8793	4
ANALOG UNIT	8966	4
CONNECTION CABLE	L9795-01	8
CONNECTION CORD	L9198	8

MR8847-51 specifications overview

Number of input units	8 analog units 16 analog channels + 16 logic channels
Maximum sampling rate	20MS/sec
Frequency characteristics	DC to 5 MHz (-3dB, when using 8966)
Memory capacity	Total 64M words

8966 specifications overview

No. of channels	2ch, voltage input
Measurement range	5 mV to 20 V/div, 12 ranges Full scale: 20 div



Related Products

Generator units for expanding the practical applications of the Memory HiCorder.
Use in various combinations with measurement units for performing tests.

Waveform Generator Unit MR8790 NEW

General specifications Accuracy guaranteed for: 1 year Post-adjustment accuracy guaranteed for 1 year

Number of output channels	4ch/unit (isolated between unit and output, and between all channels)
Self-test function	Included (voltage/current monitor)
Voltage/current monitor mode (selectable)	Resolution: 5 μ A (current monitor), 10 mV (voltage monitor) Monitor accuracy: ± 3.0 % f.s. (f.s.=10 V: voltage monitor, f.s.=5 mA: current monitor)
Max. output current	± 5 mA
Allowable load resistance	2 k Ω or more
Output terminal	SMB terminal
Output configuration	Waveform output, open, shorted
Output relay Switch time	5 ms or less
Output protection	Limited to 40 mA output current (when an output short-circuit occurs)
Maximum rated voltage to ground	33 V AC rms or 70 V DC (Between each output channel and the main unit, and between the output channels) Expected transient overvoltage: 330 V
Dielectric withstand voltage	350 V AC (sensed current: 1 mA) (Between each output channel and the main unit, and between the output channels)
Standard compliance	Safety: EN61010 EMC: EN61326
Operating temperature and humidity range	According to the Memory HiCorder installed with the MR8790
Operating environment	According to the Memory HiCorder installed with the MR8790
Storage temperature and humidity	-20°C to 50°C (-4°F to 122°F), and 90% rh or less (no condensation)
External dimensions	Approx. 106 mm (4.17 in) W \times 19.8 mm (0.78 in) H \times 196.5 mm (7.74 in) D (not including protrusions)
Weight	Approx. 230 g (8.1 oz)

Voltage output specifications

Maximum output voltage	± 10 V
Resolution	16bit
Output frequency	Setting range: DC, 0 Hz to 20 kHz (sine wave) Setting resolution: 1 Hz Frequency accuracy: ± 0.01 % of setting
Amplitude	Setting range: 0 V to 20 V p-p Setting resolution: 1 mV Amplitude accuracy: ± 0.25 % of setting ± 2 mV p-p (1 Hz to 10 kHz) ± 0.6 % of setting ± 2 mV p-p (more than 10 kHz to 20 kHz)
DC offset	Setting range: -10 V to 10 V Sum of amplitude and DC offset is limited to a peak value of ± 10 V. Setting resolution: 1 mV Offset accuracy: ± 3 mV
DC output	Output accuracy: ± 0.6 mV

The operation manual is included in the "Application Disk", bundled with the Memory HiCorder.

Model : WAVEFORM GENERATOR UNIT MR8790

Model No. (Order Code) (Note)
MR8790 (For the MR8847A or other)



Sine wave (20 kHz max.) and DC voltage output
Output configuration of 4 channels per unit.
High-precision DC output with an output accuracy of ± 0.6 mV allows output that simulates voltage fluctuations for minute sensor output.

Options

CONNECTION CABLE L9795-01

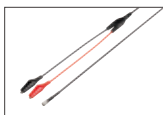

Maximum rated voltage to ground:
33 V AC rms or 70 V DC
SMB terminal - alligator clip
Cord length: 1.5 m (4.92 ft)

CONNECTION CABLE L9795-02



Maximum rated voltage to ground:
33 V AC rms or 70 V DC
SMB terminal - BNC terminal
Cord length: 1.5 m (4.92 ft)

Pulse Generator Unit MR8791 NEW

General specifications Accuracy guaranteed for 1 year

Number of output channels	8ch/unit (isolated between unit and output) (Not isolated between each channel (common ground)) (Output connector frame not isolated (main unit grounded))
Output mode 1	Pattern output/Pulse output (common 8-channel switching)
Output mode 2	Logic output/Open collector output (Can be set for each of the 8 channels)
Logic output	Output voltage level: 0 V - 5 V (H level: 3.8 V or more, L level: 0.8 V or less) Rated current: ± 5 mA
Open collector output	Absolute maximum rated voltage for collector/emitter: 50 V Overcurrent protection: 100 mA
Output mode 3	Output/Open (= self diagnostic) (common 8-channel switching)
Open collector output regulation (startup time (10% - 90%))	5 μ s (max.) (Load capacity: 1000 pF, Pull-up resistance: 1 k Ω)
Self-test function	Detected voltage: H level: 3.4 V or more, L level: 1.6 V or less
Relay switch time	5 ms or less (Logic/Open collector switch, Output/Open (self-diagnostic) switch)
Maximum rated voltage to ground	33 V AC rms or 70 V DC (between each output channel and the main unit) Expected transient overvoltage: 330 V
Dielectric withstand voltage	350 V AC (sensed current: 1 mA) (Between each output channel and the main unit, and between the output units)
Standard compliance	Safety: EN61010 EMC: EN61326
Operating temperature and humidity range	According to the Memory HiCorder installed with the MR8791
Operating environment	According to the Memory HiCorder installed with the MR8791
Storage temperature and humidity	-20°C to 50°C (-4°F to 122°F), and 90% rh or less (no condensation)
External dimensions	Approx. 106 mm (4.17 in) W \times 19.8 mm (0.78 in) H \times 196.5 mm (7.74 in) D (not including protrusions)
Weight	Approx. 230 g (8.1 oz)

Pulse output specifications

Output frequency	Setting range: 0 Hz to 20 kHz (Can be set for each of the 8 channels) Setting resolution: 0.1 Hz Frequency accuracy: Refer to the time axis accuracy of the Memory HiCorder in which the MR8791 is installed.
Duty	Setting range: 0.1% to 99.9%, 0, 100% (DC) Setting resolution: 0.1% Duty accuracy: Refer to the time axis accuracy of the Memory HiCorder in which the MR8791 is installed.
Min. pulse width	1 μ s

Pattern output specifications

Clock frequency	Range: 0 Hz to 120 kHz (common to 8 channels) Setting resolution: 10 Hz Frequency accuracy: Refer to the time axis accuracy of the Memory HiCorder in which the MR8791 is installed.
Memory (pattern)	2048 word (16384 bit=2048 word \times 8 bit/word)

The operation manual is included in the "Application Disk", bundled with the Memory HiCorder.

Model : PULSE GENERATOR UNIT MR8791

Model No. (Order Code) (Note)
MR8791 (For the MR8847A or other)



Pulse output/Pattern output, Logic/Open collector output
Output configuration of 8 channels per unit.
You can select pulse output or edited pattern output (common switching for all channels). Furthermore, you can set the output format to TTL level logic output and open collector output. (Settable for individual channels)

Note: Company names and Product names appearing in this catalog are trademarks or registered trademarks of various companies.

HIOKI

HIOKI E. E. CORPORATION

HEADQUARTERS

81 Koizumi, Ueda, Nagano, 386-1192, Japan
TEL +81-268-28-0562 FAX +81-268-28-0568
http://www.hioki.com / E-mail: os-com@hioki.co.jp

HIOKI USA CORPORATION

TEL +1-609-409-9109 FAX +1-609-409-9108
http://www.hiokiusa.com / E-mail: hioki@hiokiusa.com

HIOKI (Shanghai) SALES & TRADING CO., LTD.
TEL +86-21-63910090 FAX +86-21-63910360
http://www.hioki.cn / E-mail: info@hioki.com.cn

HIOKI SINGAPORE PTE. LTD.
TEL +65-6634-7677 FAX +65-6634-7477
E-mail: info-sg@hioki.com.sg

HIOKI KOREA CO., LTD.
TEL +82-2-2183-8847 FAX +82-2-2183-3360
E-mail: info-kr@hioki.co.jp

DISTRIBUTED BY

asita
TECNOLOGIE DI MISURA



www.asita.com