

# I modelli proposti

## Milliohmmetri



	RM3548	RM3545	RM3544	RM3543	RM3542	PME10	PME100
<b>Settori di utilizzo</b>	Verifiche in campo per assistenza e riparazione	Ricerca & Sviluppo, Linea di Produzione, Controllo Qualità		Linee di Produzione ed Integrazione su macchine automatiche per controlli in linea		Test in campo su apparati e connessioni di potenza	
<b>Applicazioni tipiche</b>	Motori, resistori, trasformatori, connettori e cablaggi	Avvolgimenti e resistori di trasformatori e motori, relè, barre di connessione, fusibili		Resistori, bobine, fusibili, schede elettroniche, cablaggi		Barrature elettriche, saldature, settore ferroviario ed aereo, interruttori di potenza	
<b>Tipologia</b>	Portatile	Da banco				Trasportabile	
<b>Misura a 4 terminali</b>	•	•	•	•	•	•	•
<b>Terminali di connessione</b>	Banana Ø4mm			BNC	BNC	Banana Ø4mm	Banana Ø8mm
<b>Risoluzione display</b>	4 ¼ cifre (35000 conteggi)	6 ½ cifre (1.200.000 cont)	5 cifre (99999 conteggi)	6 ½ cifre (1.200.000 conteggi)		3 ½ cifre (1999 conteggi)	
<b>Portate di resistenza</b>	10 portate da 3mΩ a 3MΩ	12 portate da 10mΩ a 1MΩ	9 portate da 30mΩ a 3MΩ	7 portate da 10mΩ a 1000Ω	10 portate da 100mΩ a 100MΩ	6 portate da 2mΩ a 200Ω	7 portate da 200uΩ a 20Ω
<b>Corrente di prova</b>	da 500nA a 1A	da 1uA a 1A	da 500nA a 300mA	da 1mA a 1A	da 100nA a 100mA	da 100uA a 10A	da 1mA a 100A
<b>Precisione base</b>	±0.02%	±0.006%	±0.02%	±0.16%	±0.008%	±0.25%	±0.25%
<b>Risoluzione minima</b>	0.1uΩ	0.01uΩ	1uΩ	0.01uΩ	0.01uΩ	100mΩ	10mΩ
<b>Velocità di risposta</b>	100msec	21msec	21msec	2msec	0.9msec	-	-
<b>Misura a bassa potenza (Low Power)</b>	-	•	•	-	•	-	-
<b>Misura di temperatura</b>	•	•	•	-	-	-	-
<b>Funzione di correzione per temperatura</b>	•	•	•	-	-	-	-
<b>Compensazione offset di tensione (OVC)</b>	•	•	•	•	•	-	-
<b>Funzione di calcolo statistico</b>	-	•	-	•	•	-	-
<b>Funzione comparatore</b>	•	•	•	•	•	-	-
<b>Check in prova del buon contatto</b>	•	•	•	•	•	-	-
<b>Memoria per le condizioni di prova</b>	•	•	•	-	-	-	-
<b>Memoria per i dati misurati</b>	1000 valori	-	-	30000 valori	30000 valori	-	-
<b>Interfaccia EXT I/O</b>	-	•	su RM3544/01	•	•	-	-
<b>Interfaccia RS232</b>	-	•	•	•	•	-	-
<b>Interfaccia USB</b>	•	•	•	-	-	-	-
<b>Interfaccia GP-IB</b>	-	su RM3545/01	-	su RM3543/01	su RM3542/01	-	-
<b>Software per computer</b>	-	•	•	-	X	-	-
<b>Alimentazione</b>	8 batterie LR6	da rete				da rete e batterie interne ricaricabili	

# RM3545

Altissime prestazioni, 6½ cifre, precisione 0.006%,  
risoluzione 0.01uΩ, corrente di prova fino a 1A

*High-performance, 6½ digit, 0.006% accuracy,  
0.01uΩ resolution, test current up to 1A*



Massima precisione e risoluzione per la misura di resistenza in linea di produzione, in collaudo a fine linea e in controllo accettazione.

12 portate di misura da 10mΩ a 1MΩ e risoluzione minima 0.01uΩ con tempo di risposta fino a 21msec.

EXT I/O, USB ed RS232 in dotazione, 2 versioni avanzate con GP-IB o con ingresso multiplexer a 20 canali di ingresso.

*Highest accuracy and resolution for resistance measurement in the production line, in end-line check control and control acceptance.*

*12 measurement ranges from 1mΩ to 10MΩ and minimal resolution 0.01uΩ with response time up to 21msec.*

*EXT I / O, USB and RS232 included, 2 advanced dedicated versions with GP-IB or with 20 multiplexer input channels.*

# RM3544

Alte prestazioni, 5 cifre, precisione 0.02%, risoluzione 1 $\mu\Omega$   
High performance, 5 digits, 0,02% accuracy, 1 $\mu\Omega$  resolution

M3545 - RM3544



Misuratore di resistenza ideale per test e collaudi su linee di produzione, nonché per il controllo qualità in accettazione.

Utilizzato tipicamente su avvolgimenti, resistori di trasformatori, motori, relè, barre di connessione, fusibili, copre un ampio spettro di valori resistenza con portate da 3m $\Omega$  a 3M $\Omega$  e risoluzione minima 1 $\mu\Omega$ .

La versione avanzata RM3544/01 include USB o RS232 e uscite EXT I/O.

*Resistance meter ideal for testing and inspection of production lines, as well as for quality control in acceptance.*

*Typically used on coils, resistors, transformers, motors, relays, busbars, fuses, covers a wide range of resistance values with ranges from 3m $\Omega$  to 3M $\Omega$  and minimum resolution 1 $\mu\Omega$ .*

*The advanced version RM3544/01 includes USB or RS232 outputs and EXT I/O.*

# Choose from two models based on your application



RM3545

**Super-high accuracy and multi-channel capabilities for advanced development and production applications**



RM3544

**High-precision bench-top meter for both manual operation and integration with automatic lines**

●Resistance measurement

Basic accuracy : **0.006%**      Max. resolution : **0.01μΩ**  
 Max. measurable current : **1A**

Basic accuracy : **0.02%**      Max. resolution : **1μΩ**  
 Max. measurable current : **300mA**

●Low power resistance measurement

Basic accuracy : **0.2%**      Max. resolution : **0.01mΩ**  
 Max. measurable current : **1mA**      Max. Open-circuit voltage : **20mV**

## Applications

■ Small-signal contacts

RM3545

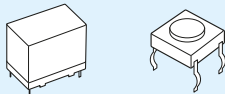

■ Motors, solenoids, choke coils, transformers, wire harnesses

RM3545 RM3544

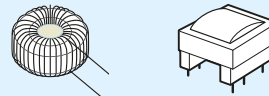

■ Compact fuses, airbag inflator, compact magnetic components (EMC filters, ferrite beads)

RM3545



■ Contacts, wire harnesses, relay contacts, switches

RM3545 RM3544

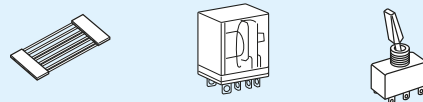

■ Multi-contact resistance measurement (motor and transformer windings)

RM3545-02

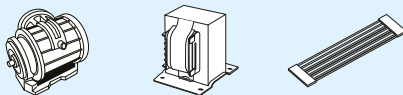

■ Fuses, resistors, heaters, wires, welds

RM3545 RM3544



■ Conductive rubber, paint

RM3545 RM3544

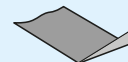

## General specifications

RESISTANCE METER RM3545		RESISTANCE METER RM3544
0.00μΩ to 1200MΩ	Measurement types (4-terminal direct current)	0.000 mΩ to 3.5 MΩ
✓	Temperature measurement, Temperature correction (TC), comparator, judgment sound setting, auto hold	✓
✓	Low power resistance measurement (LP)	N/A
✓	Temperature rise (Temperature conversion (ΔT))	N/A
✓	Offset voltage compensation (OVC)	N/A
✓	D/A output	N/A
✓ RM3545-02 : Max. 20ch	Multiplexer	N/A

## Multi-point measurement with the Multiplexer Unit Z3003 (20 locations with 4-terminal measurement)

RM3545-02

Insert up to two Z3003 units into the slots on the back of the instrument.

Scanning measurement using the Multiplexer Unit Z3003 is convenient in applications that require multi-contact measurement, for example when testing network resistors, steering switches, or 3-phase motor windings. Simply insert a Z3003 unit into one of the slots on the back of the RM3545-02 to enable scanning measurement of up to 20 locations\* with 4-terminal measurement.

(\*When using two Z3003 units, up to 42 locations can be measured with 2-terminal measurement.)



Multiplexer unit Z3003 (Option)



Pictured: Back of the RM3545-02 with two Z3003 units (optional feature installed)

### Application 1.

Measuring a 3-phase motor winding

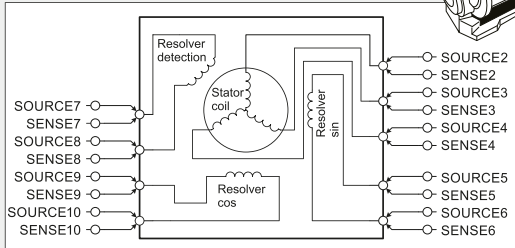
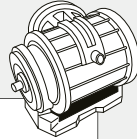

### Application 2.

Testing a connector or wiring harness

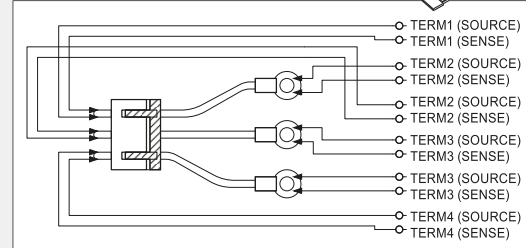
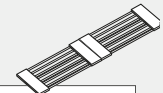

### Application 3.

Testing a relay

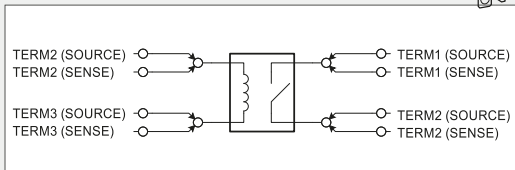

### Application 4.

Testing battery terminal welds

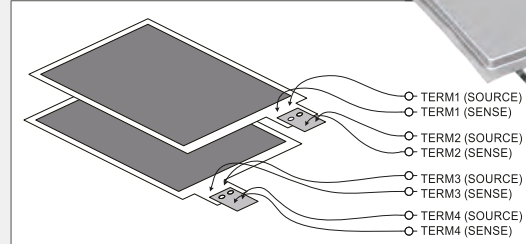
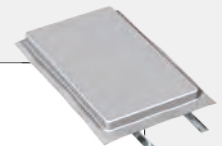

## Probes suited to manual measurement on production lines

RM3545

RM3544



CLIP TYPE LEAD L2101  
(Bundled accessory)



PIN TYPE LEAD L2102



PIN TYPE LEAD L2103



4-TERMINAL LEAD L2104

## A Full Line-up of HIOKI Resistance Meters to Suit Your Measurement Range

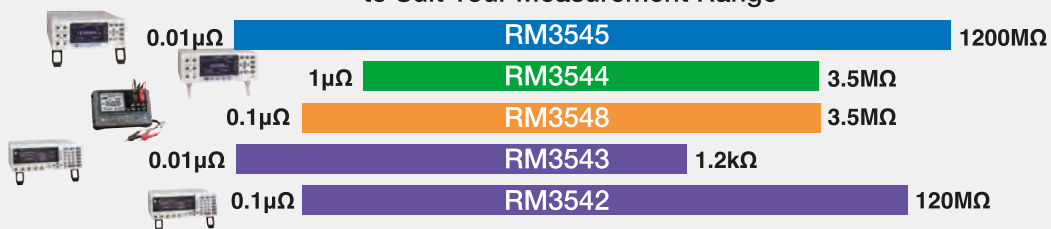

# Simplifying high-accuracy resistance measurement

## Standard features of the high-accuracy Resistance Meter RM3545 and RM3544

### Convenient wide range options RM3545 RM3544

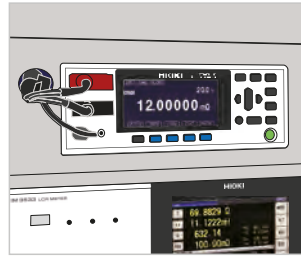
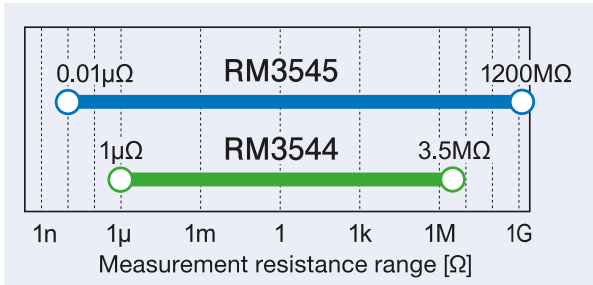

Integrate into automated inspection systems

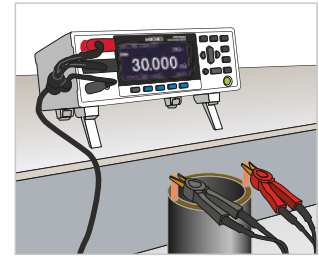

Manual testing on production lines

### Overview of the RM3545 RM3545

- Measure from 0.00 μΩ to 1200.0 MΩ
- 0.01 μΩ max. resolution, 0.006% basic accuracy
- Max. measurable current of 1A

The RM3545 can perform resistance measurement with a 6.5-digit, 1,200,000-count display at a maximum resolution of 0.01 μΩ. It delivers more than enough capabilities to be used in applications requiring high-resolution resistance measurement, for example in testing inverter motor windings.

High-resistance materials such as conductive sheets and conductive rubber are often used in electronic components. The RM3545 can measure resistance values of up to 1,200 MΩ. It also delivers maximum accuracy of 0.006%, enabling researchers to test state-of-the-art current sensing resistors.

### Overview of the RM3544 RM3544

- Measure from 0.000 mΩ to 3.5000 MΩ
- 1 μΩ max. resolution, 0.02% basic accuracy
- Max. measurable current of 300mA

As inverter-equipped power supply equipment uses increasingly high currents and frequencies, increasingly low-resistance and low-loss inductors are being incorporated in their circuitry, prompting a need for the ability to measure lower resistance levels with a high level of stability. With a resolution of 1 μΩ, the RM3544/RM3544-01 satisfy these needs.

Electronic components make extensive use of high-resistance substrates such as conductive sheets and rubber, and the RM3544/RM3544-01 deliver the ability to measure up to 3.5 MΩ.

Moreover, the instruments' maximum accuracy of 0.02% allows them to be used in testing current detectors with a precision of 0.1%.

### Guaranteed accuracy with no warm up or zero-adjustment RM3545 RM3544

For the RM3545/RM3544, accuracy is guaranteed\* immediately after startup, without any warm up or zero-adjustment.

\*When performing measurement with the RM3545 in a temperature and humidity environment that satisfies the guaranteed accuracy conditions, an even higher level of accuracy (full accuracy) is guaranteed.

### High-durability probes RM3545 RM3544

HIOKI offers a line of probes designed to accommodate the full range of measurement targets. Flex resistance has been dramatically improved (based on HIOKI comparisons).



Leads (overall view)



Example lead tip profiles

### Offset Voltage Compensation (OVC) RM3545

Thermal EMF occurs at connections between different metals. This force can affect measurement and, if large enough, introduce a measurement error. The RM3545's offset voltage correction (OVC) function reduces the effects of thermal EMF to enable more precise measurement.

### Temperature correction RM3545 RM3544

Generally, the resistance of copper wiring changes with temperature by 0.4% per degree Celsius. The RM3544/RM3545 provide a temperature correction function to convert the observed resistance value  $R_t$  at the current temperature  $t$  to the resistance value  $R_{t_0}$  at the reference temperature  $t_0$ .

\*Requires the Temperature Sensor Z2001 or a thermometer capable of generating analog voltage output (an infrared thermometer or similar instrument).

Types of temperature input	RM3544: Temperature Sensor (Z2001) RM3545: Temperature Sensor (Z2001), Analog voltage input (from an infrared thermometer, etc.)
Reference temperature setting range	-10.0 to 99.9 °C
Temperature coefficient setting range	RM3544: -9,999 to 9,999 ppm/°C RM3545: -99,999 to 99,999 ppm/°C

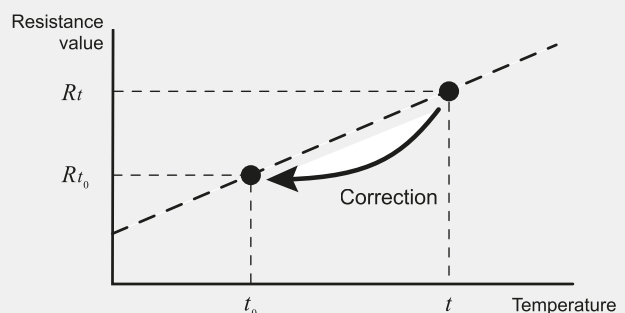

# Super-high-accuracy, multi-channel resistance meter for use in advanced development and production applications

## Key Features of the RM3545

RM3545



RM3545

### ● High/low current selection by range

Select the optimal measurement current by switching between high and low settings according to the characteristics of the sample.

### ● Extensive contact check functionality

The RM3545 can detect erroneous measurements caused by improper contact, reducing the risk that improperly judged or unchecked parts will be shipped by mistake. Contact check functionality is also provided for 4-terminal measurement.

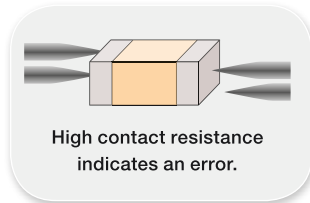

### ● Low-power (LP) resistance measurement

The RM3545 can perform measurement at a resolution of 10  $\mu\Omega$  at 1 mA (using the 1,000 m $\Omega$  range). With an open-terminal voltage of 20 mV or less, the instrument is ideally suited for measuring the contact resistance of chip inductors and signal contacts.

### ● D/A output

The RM3545 converts resistance measured values into DC voltage for output. This capability is convenient when continuously recording changes in resistance, for example as detected by a sensor, with a logger or other piece of equipment.

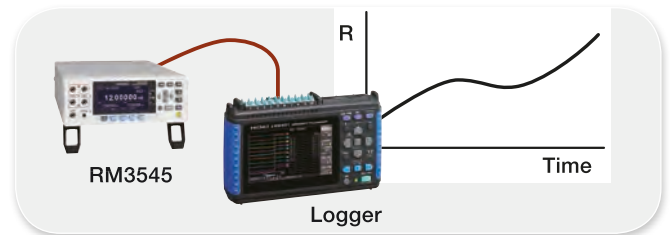

### ● Temperature input (temperature sensor terminal)

Input temperature data for use in temperature correction using either the Temperature Sensor Z2001 or a DC voltage (0 to 2 V). Connect a thermometer that can generate DC voltage output, for example an infrared thermometer, to perform temperature correction.

### ● Temperature conversion function: Useful in temperature-rise testing

Temperature increase ( $\Delta t$ ) is obtained and displayed by converting resistance measurements and ambient temperature.

## Multiplexer function (RM3545-02 only)

RM3545-02

### ● Auto-scanning and step scanning

When using the Multiplexer Unit Z3003 to perform scanning measurement, you can select either step scanning or auto scanning depending on the test conditions.

Auto scanning is convenient when you require only an overall judgment result at the completion of scanning, while step scanning is convenient when you wish to generate judgments in real time using the instrument's EXT I/O interface..

### ● Comparator judgments based on measurement results

Measurement targets that are susceptible to the effects of temperature, for example thermistors and temperature transducers, can be compared with a reference element to generate a judgment.

### ● Flexible pin assignments

The ability to freely combine pins for each channel makes it possible to perform measurement using wiring that has been optimized for a variety of measurement targets.

### ● Acquiring Total judgment results from EXT I/O

The multiplexer's total judgment result (T\_PASS, T\_FAIL, T\_ERR) can be acquired from EXT I/O. Similarly, step scan judgment results can be acquired for each step.

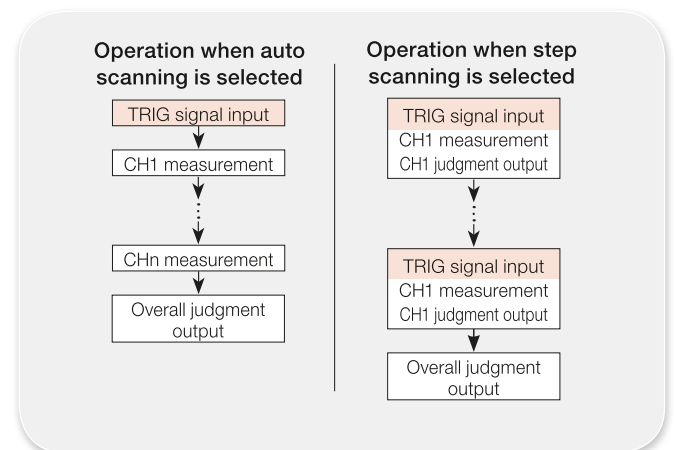

### ● Configuration using a computer

Multiplexer settings can be configured using the keys on the instrument, communications commands, or a computer application (sample PC application). The sample application can be downloaded from Hioki's website (<http://www.hioki.com>).

# Easy-to-use RESISTANCE METER

suits both manual operation and integration with automatic lines

## High-intuitive advanced functionality

RM3545 RM3544

### ① Guard terminals

Minimize the effects of external noise on measurements.

\*GUARD terminal is the shield potential.

This terminal is not for guarding network resistance measurements.

### ② Simple control over basic settings

Range and measurement speed can be controlled directly.



### ③ LED COMPARATOR ATTACHMENT (Option)

The LED Comparator Attachment indicates judgment results with green and red LEDs, eliminating the need to look at the instrument's screen and increasing work efficiency. Since the lamps do not light up when the measurement leads are open, the attachment can also be used to verify the connection status.

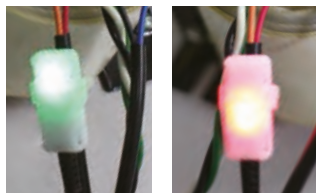

Green light  
IN state

Red light  
HI/LO state

### ④ High-volume, user-selectable judgment tones

The RM3544 indicates results with a high-volume judgment tone of 85 dB or greater to ensure it is audible near noisy machinery.

Both the RM3545 and RM3544 feature user-selectable judgment tones so workers don't confuse judgment results on lines where multiple resistance meters are being used.

### ⑤ Functionality for saving and loading panels

The RM3545 (RM3544) can save and load up to 30\* (10) sets of range, comparator, and other settings. Naming each set of panel data lets you make setup changes among production lots and lines smoothly and effortlessly.

\*When using the multiplexer terminals, up to 8.

### ⑥ Material- and temperature-independent temperature correction function

The temperature correction function can be used to convert resistance values that vary with the ambient temperature to a reference value at a reference temperature using the Temperature Sensor Z2001 and a user-specified resistance temperature coefficient.

### ⑦ Scaling

The scaling function can be used to convert resistance values into physical properties such as length.

Conversion formula :  $R_s = A \times R + B$

$A, B$  : Constants,  $R$  : Measurement value

$R_s$  : Resistance value

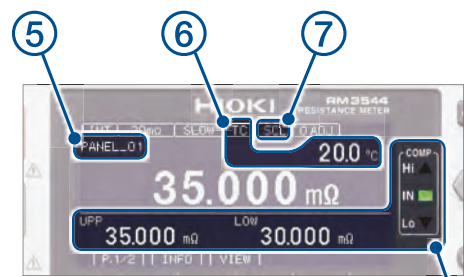

Intuitive, graphical LCD

8

### ⑧ Comparator Function

The comparator function compares measured values to a previously set reference value or range and then displays and outputs the judgment result. The RM3545 and RM3544-01 can also output this information using EXT I/O.

## High-precision specs in a compact package

RM3544



RM3544

### ● Footprint of just 215 × 166 mm

Compared to the previous model (HIOKI 3540), the RM3544/RM3544-01 take up approximately 25% less installation space.

This space-saving design frees up space in front of the instrument and lets you build compact production lines.





# Easy integration into automatic testing equipment (RM3545/-01/-02, RM3544-01)

RM3545

RM3544

## ● Ability to extend measurement cable length

The new instruments feature better wiring resistance tolerances than previous models (the 3541 and 3540). Wiring resistance can now be as high as 1.5 Ω for the RM3545 and 2 Ω for the RM3544.

## ● High-speed, comprehensive productivity support

- The RM3545 and RM3544-01 deliver the speed demanded by automatic testing equipment at a sophisticated level. The entire process from the start of measurement to outputting of the judgment result takes as little as 1.9ms (RM3545) and 18 ms (RM3544-01). One cycle of operation, lasting from measurement to judgment output, completes within this time.
- The instrument's USB interface can also be used.

- The RM3545 and RM3544-01 support RS-232C data communications at up to 115.2 kbps\*.
- The EXT I/O output mode can be switched between judgment mode and BCD mode.

\* With some computers, large error components may prevent fast transfer speeds (baud rates) from being used. In this case, change the speed to a lower setting.

## ● Handler (EXT I/O) interface

The handler interface (EXT I/O) is isolated from measurement circuitry, control circuitry, and the protective ground (chassis ground), providing a high level of noise resistance.

### ■ EXT I/O Input and Output Circuits

A switch on the rear panel is used to toggle the input signal polarity between NPN (sink output support) and PNP (source output support) settings depending on the PLC common polarity.



EXT I/O polarity  
(Select NPN/PNP)

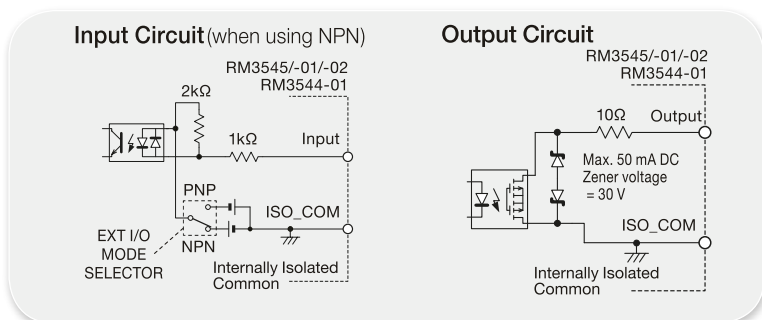

When designing a control system using the EXT I/O interface, be sure to read the instruction manual and check the necessary technical information.

### ■ EXT I/O Electrical Specifications

#### ● Inputs:

Photocoupler isolation: Non-voltage contact inputs (support for current sink output)  
Input ON: Residual voltage: Max. 1 V @4 mA  
Input OFF: Open Max. 100 μA

#### ● Outputs:

Photocoupler-isolated open drain output (no-polarity)  
DC30Vmax, DC50mAmax/ch  
Residual voltage: Max. 1 V @50 mA, or 0.5 V @10 mA

#### ● External power output:

Output voltage: Sink output support: 5.0V±10%,  
Source output support: -5.0V±10%  
Max. output current: 100mA

### ■ EXT I/O Signal List

#### ● RM3545

RM3545

#### Input Signals:

TRIG(IN0), CAL, KEY\_LOCK, 0ADJ, PRINT(IN1), MUX, SCN\_STEP, LOAD0 to LOAD5, BCD\_LOW

#### Output Signals:

[Judgment mode] EOM, ERR, INDEX, HI, IN, LO, T\_ERR, T\_PASS, T\_FAIL, BIN0 to BIN9, OB, OUT0 to OUT2  
[BCD mode] EOM, ERR, IN, HILO, BCDm\_n<sup>†</sup>, RNG\_OUT0 to RNG\_OUT3 <sup>†</sup> Indicates the nth bit of the mth digit.

#### ● RM3544-01

RM3544

#### Input Signals:

TRIG(IN0), KEY\_LOCK, 0ADJ, PRINT(IN1), LOAD0 to LOAD3, BCD\_LOW

#### Output Signals:

[Judgment mode] EOM, ERR, INDEX, HI, IN, LO, OUT0 to OUT2  
[BCD mode] EOM, ERR, IN, HILO, BCDm\_n<sup>†</sup>, RNG\_OUT0 to RNG\_OUT3 <sup>†</sup> Indicates the nth bit of the mth digit.

## ● Communications Monitor Function for smooth systems development

The Communications Monitor Function displays communications data (received commands and sent data) on the screen, providing valuable support for programming of programmable logic controllers (PLCs).

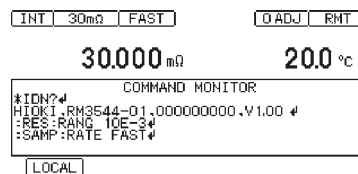

Communications Monitor screen

## ● Functionality for verifying the EXT I/O connection status and testing EXT I/O

In addition to allowing you to check EXT I/O signal input on the instrument's screen, this functionality allows you to turn output signals on or off as desired. This capability simplifies verification work during PLC programming.

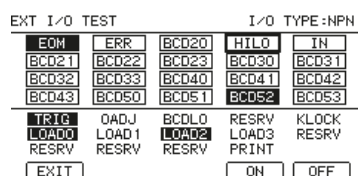

EXT I/O test function screen

## ● Connecting the instrument to a computer via RS-232C or USB

- Use a PC to control RM3545 and RM3544-01 functions as well as acquire measurement results.  
(This capability does not include turning the instrument on and off or configuring certain interface settings.)
- Connect the instrument to a commercially available RS-232C printer to print measured values, including judgment results.
- Measured values can be automatically output. By using the instrument's USB keyboard mode, measured values can be entered into applications such as spreadsheets and text editors without the need to install a special USB driver in the computer.
- The sample PC application provides functionality for capturing data based on trigger signals, performing interval measurement, conducting communication tests, and loading captured data into Microsoft® Excel or outputting it as a CSV file. The application can be downloaded from Hioki's website (<http://www.hioki.com>).

RM3545 RM3544

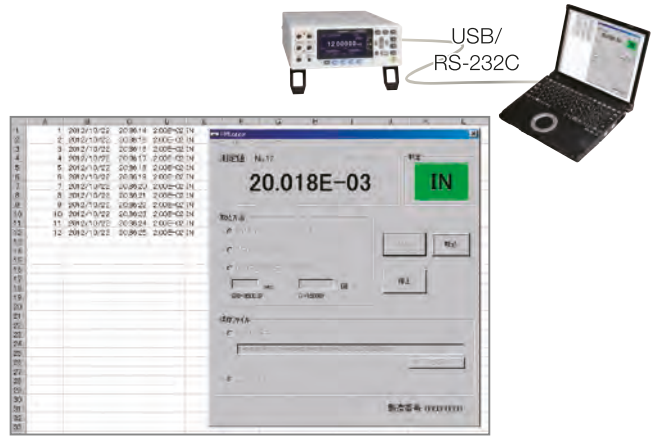

Applications screen

## ● RM3545-02 rear panel

RM3545

## ● RM3544-01 rear panel

RM3544



\*Multiplexer Units cannot be installed in the RM3545 or RM3545-01. The RM3545-01 has a GP-IB connector.

\*The RM3544 does not include EXT I/O or communication interfaces (RS-232C or USB). Select the RM3544-01 for these functions.

## ● Interface and EXT I/O selection

RM3545 RM3544

Select the interfaces and EXT I/O capability needed for your application.

RM3545 series comparison chart		(Base model)	-01	-02
External I/O (comparator, BCD, BIN function)		✓	✓	✓
Communication interfaces	RS-232C/Printer/USB	✓	✓	✓
	GP-IB	N/A	✓	N/A
Multiplexer* (scanner function)		N/A	N/A	✓ (Max. 20 channels)

\*When using 4-terminal measurement with two MULTIPLEXER UNIT Z3003 (option) cards.

RM3544 series comparison chart		(Base model)	-01
External I/O (comparator, BCD)		N/A	✓
Communication interfaces RS-232C/Printer/USB		N/A	✓

## ■ MULTIPLEXER UNIT Z3003 Specifications

Product warranty: 1 year

RM3545-02

Measurement targets	4-wire: 10 locations (when using 2 units, 20 locations) 2-wire: 21 locations (when using 2 units, 42 locations)
Measurable range	[Measurement current] Internal instrument: 1A DC or less External instrument: 1A DC or less, 100 mA AC or less [Measurement frequency] External instrument DC, 10 Hz to 1 kHz
Contact specifications	Contact type: Mechanical relay Maximum allowable voltage: 33 V RMS and 46.7 V peak or 70 V DC *1 Maximum allowable power: 30 W (DC), (Resistance load) Contact service life: 4-wire: 50 million cycles*2 (reference value)
Dimensions	Approx. 92W × 24.5H × 182D mm (3.62"W × 0.96"H × 7.17"D) (without projections)
Mass	Approx. 180 g (6.3 oz)
Accessories	Instruction manual ×1, D-SUB 50pin connector ×1

\*Example scanning times

The Z3003 switching time is 30 ms/ch.

Range	Number of channels	Measurement speed	Delay	Time to output judgment results after TRIG input
1000mΩ	10	FAST	0 ms	Approx. 300ms
1000mΩ	10	FAST	Preset	Approx. 800ms

\*1 Cannot be used in combination with a withstand voltage tester. When used with a withstand voltage tester, the Z3003's internal relay will cause an insulation breakdown, resulting in electric shock or equipment damage.

\*2 Assuming 24-hour operation, the guideline of 50 million cycles corresponds to approximately 1.5 years on a line operating at 1 sec. per workpiece or approximately 15 years on a line operating at 10 sec. per workpiece.

	RM3545	RM3544
Measurement types	Resistance measurement: 0.000 00mΩ (10mΩ range) to 1200.0MΩ (1000MΩ range), 12 ranges Low power resistance measurement: 0.00mΩ (1000mΩ range) to 1200.00Ω (1000Ω range), 4 ranges Temperature measurement (thermistor): -10.0 to 99.9°C Temperature measurement (analog input): -99.9 to 999.9°C	Resistance measurement: 0.000mΩ (30mΩ range) to 3.500 0MΩ (3MΩ range), 9 ranges Temperature measurement (thermistor): -10.0 to 99.9°C
Measurement method	4-terminal direct current (constant current), banana plug, with guard terminal	
Range switching	Auto or Manual	
Temperature correction	Reference temperature setting range: -10°C to 99.9°C, Temperature coefficient setting range: -99,999 ppm/°C to 99,999 ppm/°C	Reference temperature setting range: -10°C to 99.9°C, Temperature coefficient setting range: -9,999 ppm/°C to 9,999 ppm/°C
Zero-adjustment	By range, by step (RM3545-02 only) Within ±50% f.s. of each range. (Zero-adjustment is not required for 100 MΩ or greater ranges.)	Within -3% to 50% f.s. of each range. (f.s.= 30,000 dgt.)
Trigger	Internal or external	RM3544: Internal trigger, RM3544-01: Internal or external
Measurement speed	FAST / MED / SLOW1 / SLOW2	FAST / MED / SLOW
Delay	Internal fixed value: / 0 to 9999 ms (1ms step)	N/A
Functions	Temperature correction, Temperature conversion, Self-calibration, offset voltage compensation (OVC), comparator (ABS/REF%), BIN, key-lock (OFF, menu lock, all lock), display digit count selection function (7 digits/6 digits/5 digits), automatic power supply frequency settings (AUTO/50Hz/60Hz), scaling, judgment sound setting, auto hold, statistical calculations, clock, self-test, L2105 LED Comparater Attachment output	Temperature correction, comparator (ABS/REF%), key-lock (OFF, menu lock, all lock), display digit count selection function (5 digits/4 digits), automatic power supply frequency settings (AUTO/50Hz/60Hz), scaling, judgment sound setting, auto hold, L2105 LED Comparater Attachment output
Measurement fault detection functions	Contact check, over detection, current fault detection	Over detection, current fault detection
Averaging	OFF, 2 to 100 averaging iterations (variable in 1-iteration steps)	
Panel store, panel load	30 (Front terminals), 8 (MUX (multiplexer)) Panel save parameters: save time and date, resistance measurement ranges, measurement speed, comparator, BIN setting, multiplexer setting, etc.	10 Panel save parameters: resistance measurement ranges, measurement speed, comparator, etc.
Multiplexer	RM3545-02: Number of installed units: Max. 2 Measurement terminal settings : Front terminals / MUX (multiplexer) When using the MUX setting, the measurement leads cannot be connected to the front measurement terminals Support unit: Z3003 Number of channels that can be set: 42, switching time 30 ms (reference value)	N/A
D/A output	Output: resistance measured value Output voltage: 0V DC to 1.5V DC Output impedance: 1kΩ Number of bits: 12bit	N/A
EXT I/O	TRIG and other, BIN, BCD	RM3544-01: TRIG and other, BCD
Communication interfaces	Select from GP-IB*, RS-232C, PRINTER(RS-232C), or USB *RM3545-01 only	RM3544-01: Select from RS-232C, PRINTER(RS-232C), or USB
Communication interfaces	Remote function, communications monitor function, data output function, memory (50 data)	Remote function, communications monitor function, data output function
RS-232C	Bit rates: 115,200 / 38,400 / 19,200 / 9,600 bps	
USB	Class: CDC (COM mode), HID (USB keyboard mode)	
Printer (RS-232 port)	Printed data: Resistance measurement values, temperature measurement values, judgment results, measurement conditions, statistical results Operation: Prints at PRINT signal or PRINT key input. Interval: ON/OFF, Interval times: 1 to 3,600 s (variable in 1 s steps), Number of print columns per row: 1 or 3	Printed data: Resistance measurement values, temperature measurement values, judgment results, measurement conditions
Operating temperature and humidity	0 to 40°C, 80% rh or less (non-condensating)	
Storage temperature and humidity	-10 to 50°C, 80% rh or less (non-condensating)	
Operating environment	Indoors, Pollution Degree 2, up to 2,000 m ASL	
Power supply	Rated supply voltage: 100 to 240 VAC ±10%, Rated supply frequency: 50/60 Hz	
Rated power consumption	40 VA	15 VA
Insulation withstand potential	1.62 kV AC for 1 min. (with 10 mA cutoff current), between all mains supply terminals and protective ground, interfaces, and measurement terminals	
Dimensions	Approx. 215W × 80H × 306.5D mm (8.46"W × 3.15"H × 12.07"D) (without projections)	Approx. 215W × 80H × 166D mm (8.46"W × 3.15"H × 6.54"D) (without projections)
Mass	RM3545, RM3545-01: Approx. 2.5 kg (88.2 oz) RM3545-02: Approx. 3.2 kg (112.9 oz) (not including Z3003)	RM3544: Approx. 0.9 kg (31.7 oz) RM3544-01: Approx. 1.0 kg (35.3 oz)
Accessories	Power cord ×1, CLIP TYPE LEAD L2101 ×1, temperature sensor Z2001 ×1, male EXT I/O connector ×1, instruction manual ×1, application disc ×1, USB cable (A-to-B type) ×1, extra fuse ×1	Power cord ×1, CLIP TYPE LEAD L2101 ×1, male EXT I/O connector* ×1, instruction manual ×1, application disc* ×1, USB cable (A-to-B type)* ×1, extra fuse ×1 *Included with RM3544-01.
Applicable standards	Safety: EN61010, EMC: EN61326, EN61000-3-2, EN61000-3-3	

● Conditions of guaranteed accuracy

- Temperature & humidity: 23 °C ±5 °C, 80% rh or less (non-condensating)
- From 0°C to 18°C and from 28°C to 40°C, add (temperature coefficient ±[1/10 measurement accuracy] / °C).
- Guaranteed Accuracy Period: 1 year
- RM3545 only: Warmup time of 60 min. or greater (If less than 60 min., double figures in the accuracy table to obtain the measurement accuracy.)
- RM3545 only: self-calibration AUTO

\*When using manual self-calibration, temperature fluctuations after performing calibration must be within ±2°C, and the calibration interval must be within 30 min.

\* During temperature correction, the value calculated below is added to the rdg. error for resistance measurement accuracy:

$$\frac{-\alpha_{t0}\Delta t}{1 + \alpha_{t0} \times (t + \Delta t - t_0)} \times 100 \quad [\%]$$

$t_0$  : Reference temperature. [°C]  
 $t$  : Ambient temperature. [°C]  
 $\Delta t$  : Temperature. measurement accuracy  
 $\alpha_{t0}$  : Temperature. coefficient at  $t_0$  is [1/°C]

Resistance measurement accuracy

● RM3545

RM3545

Accuracy = ±(% rdg. + % f.s.)

(Example) 0.006 + 0.001 ..... 0.006% rdg. + 0.001% f.s.

LP OFF

- f.s. = calculated 1,000,000 dgt., where 0.001% f.s. = 10 dgt.
- For 100 MΩ and greater ranges with 100 MΩ range high-precision mode off, calculate as f.s. = 10,000 dgt. and 0.01% f.s. = 1 dgt.

Range	100MΩ range high-precision mode	Max. measurement display <sup>1</sup>	Resolution	Accuracy %rdg. + %f.s. <sup>2</sup>				Measurement current <sup>3</sup>		Additional accuracy without 0ADJ %f.s. <sup>2</sup>	Max open-terminal voltage		
				FAST	MED	SLOW1	SLOW2	Switching					
10mΩ	-	12.000 00 mΩ	10 nΩ	0.060+0.050 (0.060+0.015)	0.060+0.020 (0.060+0.002)	0.060+0.020 (0.060+0.001)	0.060+0.010 (0.060+0.001)	0.060+0.010 (0.060+0.001)	–	1A	0.020 (–)	5.5V <sup>4</sup>	
100mΩ		120.000 0 mΩ	100 nΩ	0.060+0.010 (0.060+0.003)	0.060+0.010 (0.060+0.001)	0.060+0.010 (0.060+0.001)	0.060+0.010 (0.060+0.001)	High	1A	0.002 (–)			
				0.014+0.050 (0.014+0.015)	0.014+0.020 (0.014+0.002)	0.014+0.020 (0.014+0.001)	0.014+0.020 (0.014+0.001)	Low	100mA	0.020 (–)			
1000mΩ		1200.000 mΩ	1 μΩ	0.012+0.010 (0.012+0.003)	0.012+0.008 (0.012+0.001)		0.012+0.008 (0.012+0.001)		High	100mA	0.002 (–)		
				0.008+0.050 (0.008+0.015)	0.008+0.020 (0.008+0.002)		0.008+0.020 (0.008+0.002)		Low	10mA	0.020 (–)		
10Ω		12.000 00 Ω	10 μΩ	0.008+0.010 (0.008+0.003)	0.008+0.008 (0.008+0.001)		0.008+0.008 (0.008+0.001)		High	10mA	0.002 (–)		
				0.008+0.050 (0.008+0.015)	0.008+0.020 (0.008+0.002)		0.008+0.020 (0.008+0.002)		Low	1mA	0.020 (–)		
100Ω		120.000 0 Ω	100 μΩ	0.007+0.005 (0.007+0.005)	0.007+0.002 (0.007+0.001)	0.007+0.001 (0.007+0.001)		0.007+0.001 (0.007+0.001)		High	10mA		– (–)
				0.008+0.010 (0.008+0.003)	0.008+0.010 (0.008+0.001)				Low	1mA	0.002 (–)		
1000Ω		1200.000 Ω	1 mΩ	0.007+0.005 (0.007+0.005)	0.006+0.002 (0.006+0.001)	0.006+0.001 (0.006+0.001)		0.006+0.001 (0.006+0.001)		–	1mA		– (–)
10kΩ	12.000 00 kΩ	10 mΩ	0.008+0.005	0.007+0.002	0.007+0.001		0.007+0.001		–	1mA	20V		
100kΩ	120.000 0 kΩ	100 mΩ	0.008+0.005	0.007+0.002	0.007+0.001		0.007+0.001		–	100μA			
1000kΩ	1200.000 kΩ	1 Ω	0.015+0.005	0.008+0.002	0.008+0.001		0.008+0.001		–	10μA			
10MΩ	12.000 00 MΩ	10 Ω	0.030+0.005	0.030+0.002	0.030+0.001		0.030+0.001		–	1μA			
100MΩ	ON	120.000 0 MΩ	100 Ω	0.200+0.005	0.200+0.002	0.200+0.001		0.200+0.001		–		100nA	
	OFF	120.00 MΩ	10 kΩ	10.00MΩ or less : 0.50+0.02 10.01MΩ or more : 1.00+0.02				Max.		1μA			
1000MΩ	OFF	1200.0 MΩ	100 kΩ	100.0MΩ or less : 1.00+0.02 100.1MΩ or more : 10.00+0.02									

<sup>1</sup> For negative values, to -10% f.s. The maximum display range is 9,999,999 dgt. or 9 GΩ. (An over-range error will be indicated when the maximum measurement range is exceeded, even if the maximum display range is not exceeded.)

<sup>2</sup> Measurement accuracy figures reflect accuracy after zero-adjustment. If not performing zero-adjustment, add the figures shown in the “Additional accuracy without 0ADJ” column. Figures shown in parentheses on the second line indicate the additional accuracy with OVC on.

<sup>3</sup> Measurement current accuracy is ±5%.

<sup>4</sup> When using an external trigger source or performing measurement with continuous measurement set to off (other than free-run), the open-circuit voltage from 1 ms after the completion of measurement (INDEX = ON) to the start of the next measurement (TRIG = ON) is limited to 20 mV or less.

LP ON • f.s. = calculated 100,000 dgt., where 0.001% f.s. = 1 dgt.

Range	100MΩ range high-precision mode	Max. measurement display <sup>1</sup>	Resolution	Accuracy %rdg. + %f.s. <sup>2</sup>				Measurement current <sup>3</sup>		Additional accuracy without 0ADJ %f.s. <sup>2</sup>	Max open-terminal voltage
				FAST	MED	SLOW1	SLOW2	Switching			
1000mΩ	-	1200.00 mΩ	10 μΩ	0.200+0.010	0.200+0.010	0.200+0.005	0.200+0.003	–	1mA	–	20mV <sup>5</sup>
10Ω		12.000 0 Ω	100 μΩ	0.200+0.005	0.200+0.005	0.200+0.003	0.200+0.002	–	500μA		
100Ω		120.000 Ω	1 mΩ	0.200+0.005	0.200+0.005	0.200+0.003	0.200+0.002	–	50μA		
1000Ω		1200.00 Ω	10 mΩ	0.200+0.005	0.200+0.005	0.200+0.003	0.200+0.002	–	5μA		

<sup>1</sup> For negative values, to -10% f.s. The maximum display range is 9,999,999 dgt. or 9 GΩ. (An over-range error will be indicated when the maximum measurement range is exceeded, even if the maximum display range is not exceeded.)

<sup>2</sup> Measurement accuracy figures reflect accuracy after zero-adjustment. LP values apply only when OVC is on.

<sup>3</sup> Measurement current accuracy is ±5%.

<sup>5</sup> When the contact check function is off (when the contact check function is on, 300 mV)

## ● Additional accuracy when using the Z3003

RM3545

When performing measurements using the Z3003, the following uncertainties are added to the RM3545 specifications (accuracy):

Z3003 additional error	
Effects of leak current	Add a reading error shown on right depending on the measurement current (when using guarding) (With humidity of less than 70% RH. If the humidity is greater than or equal to 70% RH, add the following rdg. error × 5.): $\frac{1 \times 10^{-9} [\text{A}]}{I_{\text{MEAS}} [\text{A}]} \times 100 [\% \text{rdg.}]$
Effect of measurement speed	Add the f.s. error component shown on right when the integration time is not a whole-number multiple of the power supply cycle: $A_{\text{fs}} \times 0.5 [\% \text{rdg.}]$
Effect of offset voltage	Add the resistance shown on right to the error when OVC is OFF: $\frac{10 \times 10^{-6} [\text{V}]}{I_{\text{MEAS}} [\text{A}]} [\Omega]$
Effect of offset resistance fluctuations	When using a 2-wire setup, add the wiring resistance shown on right to the error component. $0.1 \Omega$
Temperature coefficient	From 0°C to 18°C and 28°C to 40°C, add a temperature coefficient of $\pm(1/10 \text{ of additional accuracy}) / ^\circ\text{C}$ .

$I_{\text{MEAS}}$  : Measurement current  
 $A_{\text{fs}}$  : f.s. error component for RM3545-02 with Z3003

## ● RM3544

RM3544

Accuracy =  $\pm(\% \text{ rdg.} + \% \text{ f.s.})$

• f.s. = calculated 30,000 dgt., where 0.010% f.s. = 3 dgt.

(Example) 0.020 + 0.007 ..... 0.020% rdg. + 0.007% f.s.

Range	Max. measurement display <sup>6,7</sup>	FAST	MED/SLOW	Measurement Current <sup>8</sup>	Open-Circuit Voltage
30mΩ	35.000 mΩ	0.030+0.080	0.030+0.070	300mA	5.5Vmax.
300mΩ	350.00 mΩ	0.025+0.017	0.025+0.014	300mA	
3Ω	3.500 0 Ω	0.025+0.017	0.025+0.014	30mA	
30Ω	35.000 Ω	0.020+0.010	0.020+0.007	10mA	
300Ω	350.00 Ω	0.020+0.010	0.020+0.007	1mA	
3kΩ	3.500 0 kΩ	0.020+0.010	0.020+0.007	1mA	
30kΩ	35.000 kΩ	0.020+0.010	0.020+0.007	100μA	
300kΩ	350.00 kΩ	0.040+0.010	0.040+0.007	5μA	
3MΩ	3.500 0 MΩ	0.200+0.010	0.200+0.007	500nA	

\*6 For negative values, to -10% f.s.

\*7 The maximum display range is 99,999dgt.

\*8 Measurement current accuracy is  $\pm 5\%$ .

## ■ Temperature measurement accuracy (RM3544/RM3545)

• Temperature Sensor Z2001 (for RM3544/RM3544-01)

RM3545

RM3544

Range of guaranteed accuracy	-10.0 to 99.9 °C
Display refresh rate	Approx. 2 s
Guaranteed accuracy period	1 year

• Analog Input (for RM3545)

RM3545

Guaranteed accuracy range	0 to 2 V
Maximum allowable voltage	2.5V
Resolution	1mV
Display range	-99.9 to 999.9 °C
Measurement period (speed)	Approx. 50 ms, no moving average
Period of guaranteed accuracy	1 year
Accuracy	$\pm 1\% \text{rdg.} \pm 3 \text{ mV}$

• Temperature Sensor Z2001 and RM3545/RM3544/RM3544-01 combined accuracy

t: Temperature measurement values [°C]

Temperature	Accuracy
-10.0 °C to 9.9 °C	$\pm (0.55 + 0.009 \times  t-10 ) \text{ } ^\circ\text{C}$
10.0 °C to 30.0 °C	$\pm 0.50 \text{ } ^\circ\text{C}$
30.1 °C to 59.9 °C	$\pm (0.55 + 0.012 \times  t-30 ) \text{ } ^\circ\text{C}$
60.0 °C to 99.9 °C	$\pm (0.92 + 0.021 \times  t-60 ) \text{ } ^\circ\text{C}$

Standalone instrument accuracy:  $\pm 0.2 \text{ } ^\circ\text{C}$

## ■ Resistance D/A output accuracy (RM3545)

RM3545

Output accuracy	Resistance measurement accuracy $\pm 0.2\% \text{f.s.}$ , (temperature coefficient $\pm 0.02\% \text{f.s./} ^\circ\text{C}$ )
Response time	Measurement time + Max. 1 ms

## ■ Measurement speed typical values (RM3545)

RM3545

Range	Measurement current	Measurement speed (ms)				
		FAST	MED		SLOW1	SLOW2
50Hz	60Hz					
10 mΩ	N/A	41	61	58	141	241
100 mΩ	High	41	61	58	141	241
1000 mΩ	High	2.2	22	19	102	202
10 Ω	High	2.2	22	19	102	202
100 Ω	High	2.8	23	20	103	203

Tolerance:  $\pm 10\% \pm 0.2 \text{ ms}$

\* Shortest time when using an external trigger source or with continuous measurement off (other than free-run). With a delay of 10 ms, TC on, comparator on, OVC off, and averaging off. Measurement speed varies with the selected range and settings. For more information, please see the Instruction Manual.

## ■ Measurement time (RM3544)

RM3544

Measurement speed (ms)			
FAST		MED	SLOW
50Hz	60Hz		
21	18	101	401

Tolerance:  $\pm 10\% \pm 2 \text{ ms}$

\* With TC set to ON and the comparator set to ON

## Model Configurations and Options



**RESISTANCE METER RM3545**  
**RESISTANCE METER RM3545-01**  
 (with GP-IB)

**RESISTANCE METER RM3545-02**  
 (supports use of the MULTIPLEXER UNIT Z3003)

(Accessories: Power Cord  $\times 1$ , CLIP TYPE LEAD L2101  $\times 1$ , TEMPERATURE SENSOR Z2001  $\times 1$ , male EXT I/O connector  $\times 1$ , instruction manual  $\times 1$ , applications disc  $\times 1$ , USB cable (A-to-B type)  $\times 1$ , extra fuse  $\times 1$ )



**RESISTANCE METER RM3544**  
 (Accessories: Power cord  $\times 1$ , CLIP TYPE LEAD L2101  $\times 1$ , instruction manual  $\times 1$ , extra fuse  $\times 1$ )

**RESISTANCE METER RM3544-01**  
 (EXT I/O, with communication interface)  
 (Accessories: Power Cord  $\times 1$ , CLIP TYPE LEAD L2101  $\times 1$ , male EXT I/O connector  $\times 1$ , instruction manual  $\times 1$ , applications disc  $\times 1$ , USB cable (A-to-B type)  $\times 1$ , extra fuse  $\times 1$ )

### Caution when considering the use of probes without guard terminals

Proper operation of the RM3545 and RM3544 is not guaranteed when using test leads (test probes) that lack guard terminals, for example test leads used with models such as the Resistance HiTester 3541 or m $\Omega$  HiTester 3540. Please use the test leads indicated in the RM3545 and RM3544 accessory and option documentation.

## Options

### Multiplexer Unit (for RM3545-02)



**MULTIPLEXER UNIT Z3003**

### Note on probe length

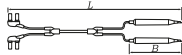

B: Probe length  
 L: Overall length

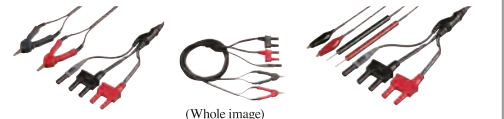

**CLIP TYPE LEAD L2101**  
 (Bundled accessory)

B: 83 mm (3.27 in), L: 1.5 m (4.92 ft)

**4 -TERMINAL LEAD L2104**

B: 118 mm (4.65 in), L: 1.5 m (4.92 ft)



**TEMPERATURE SENSOR Z2001**  
 (RM3545/RM3545-01/  
 RM3545-02 Bundled accessory,  
 RM3544/RM3544-01 Option)  
 1.75 m (5.74 ft)

**LED COMPARATOR ATTACHMENT L2105**  
 2 m (6.56 ft)

**RS-232C CABLE 9637**  
 for PC connection, 9pin - 9pin, cross, 1.8 m (5.91 ft)

**RS-232C CABLE 9638**  
 for PC connection, 9pin - 25pin, cross, 1.8 m (5.91 ft)

**GP-IB CONNECTOR CABLE 9151-02**  
 2 m (6.56 ft)



**PIN TYPE LEAD L2102**  
 B: 140 mm (5.51 in), L: 1.5 m (4.92 ft)



**PIN TYPE LEAD L2103**  
 B: 138 mm (5.43 in), L: 1.5 m (4.92 ft)

## Related products

- Large motors, large transformers



- Vehicle grounding lines, conductivity of aircraft fuselages



- Temperature rise tests (Motors, choke coils, transformers)



## High-precision portable resistance meter measures from $\mu\Omega$ to $M\Omega$



## RESISTANCE METER RM3548

Basic accuracy : **0.02%**

Max. resolution : **0.1  $\mu\Omega$**

Max. measurable current : **1 A**

- Measure from 0.0  $\mu\Omega$  (@ 1 A) to 3.5  $M\Omega$
- Easily record up to 1,000 data points in memory simply by applying the instrument's probes.
- Smoothly capture temperature-rise test data using interval measurement.
- Portable design is ideal for maintenance and testing of large equipment.

For more information, please visit <http://www.hioki.com>.