

CATALOGO STRUMENTI

Ricerca & Sviluppo

MONITORAGGIO E CONTROLLO

DATA LOGGER

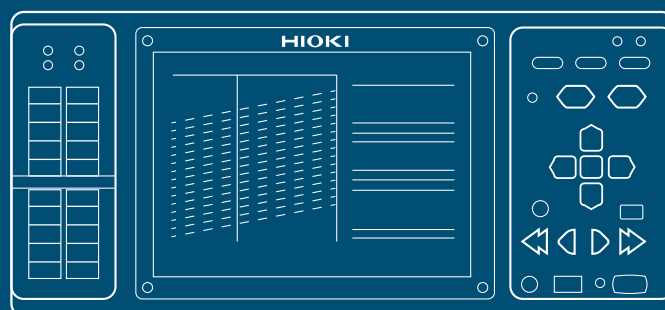

TECNOLOGIA

HIOKI

asita

TECNOLOGIE DI MISURA



INDICE

MONITORAGGIO E CONTROLLO

Data Logger	p 3
LR8410	p 3
LR8400 - LR8401 - LR8402	p 15
LR8431	p 27
LR8432	p 35
8423	p 47
LR85xx serie	p 59
LR5000 serie	p 67

STRUMENTI **R&S**

MISURE PRIMARIE

- IMPEDENZIMETRI
- PONTI LCR
- OHMETRI - MICROHMETRI - MILLIOHMETRI - MEGA-OHMETRI - SUPER-MEGA-OHMETRI
- MULTIMETRI
- VOLTMETRI
- WATTMETRI

MONITORAGGIO E CONTROLLO ◀

- DATA LOGGER ◀
- OSCILLOSCOPI REGISTRATORI

PROVE E VERIFICHE

- PROVA BATTERIA
- PROVA RIGIDITA' DIELETTRICA ED ISOLAMENTO
- PROVA ISOLAMENTO
- PROVA DI CONTINUITA'
- PROVA CORRENTE DISPERSA

SENSORI e ACCESSORI

HIOKI

WIRELESS LOGGING STATION LR8410

Up to 105 channels*

*When used with LR8510 or LR8511 measurement units.

Wireless Data Collection

Featuring Bluetooth® wireless technology, faster wiring of multichannel input, and easy distributed setup.



Please see www.hioki.com for list of supported regions.

Easy expansion with an extensive selection of measurement units and loggers

Data is sent wirelessly to the wireless logging station from measurement units and wireless loggers.

Wireless loggers

WIRELESS PULSE LOGGER
LR8512



WIRELESS CLAMP LOGGER
LR8513



WIRELESS HUMIDITY LOGGER
LR8514



WIRELESS VOLTAGE/TEMP LOGGER
LR8515



Measurement units

WIRELESS VOLTAGE/TEMP UNIT LR8510



WIRELESS UNIVERSAL UNIT LR8511



Communication range: 30 m, line of sight

Number of units: Up to 7

(including mixture of measurement units and wireless loggers)

Measurement units and wireless loggers

		LR8510	LR8511	LR8512	LR8513	LR8514	LR8515
No. of input channels		15	15	2	2	2	2
Input type	Voltage	✓	✓				✓
	Temperature	✓	✓			✓	✓
	Humidity		✓			✓	
	Resistance		✓				
	Pulse			✓			
	Current				✓		

LR8510/LR8511

Voltage

Fully isolated input channels
Maximum rated voltage to earth: 300 VAC, DC
Max. inter-channel voltage: 300 VDC

LR8510/LR8511

Thermocouple

K, J, E, T, N, R, S, B, W
Measurement range varies with thermocouple type (see specifications page).

LR8511

Pt100/ JPt100

Pt100 :-100 to 800°C
JPt100 :-100 to 500°C
3-wired/ 4-wired, 1mA testing current

LR8511

Resistance

0 to 200 Ω
Measurement ranges:
10/20/100/200Ω

LR8511

Humidity

5.0 to 95.0 %rh
Requires Humidity Sensor Z2000 (option).

LR8512

Pulse

Flow rate·No. of revolutions
Non-voltage "a" contact
Open collector, or voltage input (0 to 50V)

LR8513

Current using sensors

AC and DC load current and AC leak current
Measurement range varies with clamp type (see option page).

LR8514

Temperature, humidity

Dedicated temperature and humidity sensor (optional)
Z2010 (50 mm long, including sensor)
Z2011 (cable length: 1.5 m)

LR8515

Voltage

0 to 50V
Measurement range:
50m/500m/5/50V

LR8515

Thermocouple

K, T
Requires thermocouple

Wireless data transmission for superior ease of use



1. Making the wiring process faster while minimizing costs

Have you dealt with problems like these?

Recording a large number of channels means you'll have to deal with a mess of wires. In addition to increasing the cost of connection cables and thermocouples, long wires make setup more time-consuming.



Resolved with wireless data transmission

The lack of wiring around the instrument makes for a clean installation. Minimal wiring means lower costs and faster setup.



Long wires are used to connect the instrument to the measurement locations.



Data is sent wirelessly from measurement units to the LR8410.

2. Make measurements where it would not be practical to wire equipment directly.

Have you dealt with problems like these?

Running a large number of thermocouples from a logger to the ceiling or crawlspace would mean a wiring nightmare. Data can't be viewed during measurement, and data download is virtually impossible. Logging for extended periods requires extra power, something traditional loggers can't support.



Resolved with wireless data transmission

There's no need to connect measurement units to the Wireless Logging Station LR8410 with long wires. Instead, you can install the logging module in an attic or crawlspace and check data from the LR8410's screen while measurement is ongoing.

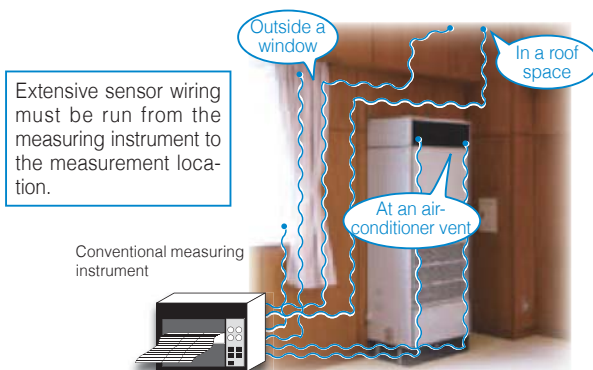

Monitoring the temperature near wall-mounted air-conditioners, in high places such as roof spaces, or in crawl spaces

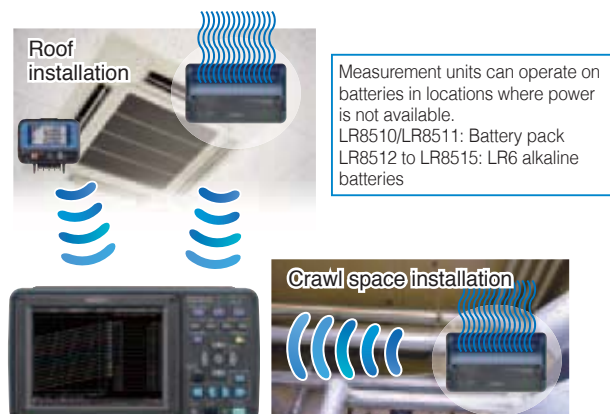



3. Make measurements of interior conditions from the outside, with the door closed.

Have you dealt with problems like these?

We can't close the windows or doors due to all the wires. As a result, there's a gap in the gasket, and the vehicle cannot be sealed.

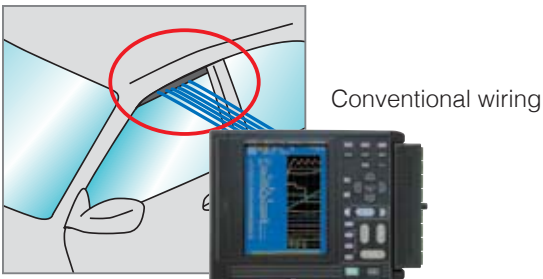

Long wires are used to connect the instrument to the measurement locations.

Resolved with wireless data transmission

Wires do not protrude outside the vehicle, allowing the windows and doors to be closed so that the vehicle can be tested under airtight conditions.



Data is sent wirelessly from measurement units and wireless loggers to the LR8410.

The communications range between the LR8410 and measurement units/wireless loggers is 30 m (line of sight). The communications range may be reduced if there are obstructions (such as walls or metallic shielding) between the devices.

4. Synchronize measurement data

Have you dealt with problems like these?

Installing individual loggers on test equipment means each set of measured data is on its own time line, making it hard to compare the data with respect to a single time axis. Conventional data loggers are sometimes too bulky and difficult to fit into test equipment.

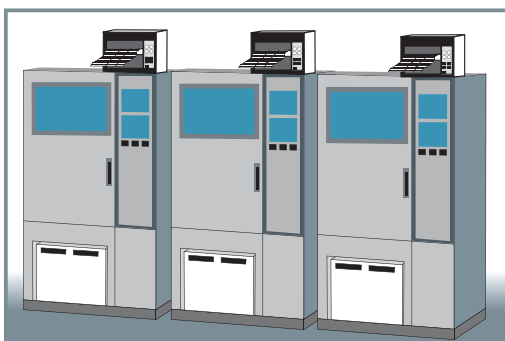

Traditionally, data loggers are installed on each device

Resolved with wireless data transmission

You can observe measurement results from multiple pieces of experimental equipment as part of the same time series. Logging modules are small enough to fit almost anywhere.

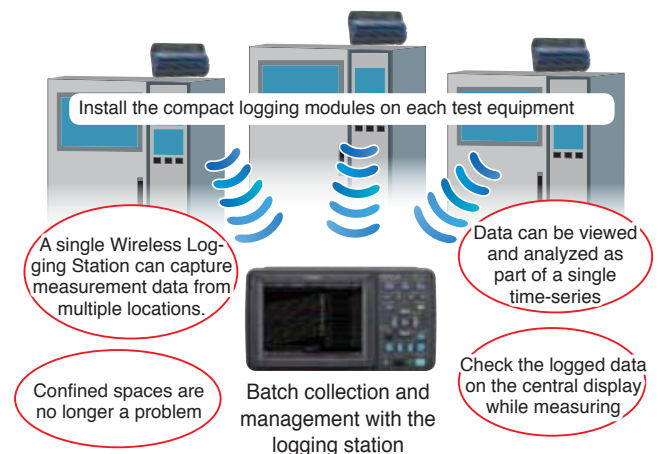

Applications in diverse fields

Introducing three-way power, including extended measurement on battery power!

AC adapter, battery, or DC power supply

Measurement units or wireless loggers can operate on a rechargeable battery pack or alkaline batteries, respectively, close to the measurement target, enabling their use even in locations where AC power is not available.



Continuous operating time (LR6 Alkaline battery)

Recording intervals	LR8512	LR8513	LR8514	LR8515
0.1 sec *1	Approx. 5 day	Approx. 5 day	Approx. 5 day	Approx. 2 day
1 sec	Approx. 7 days	Approx. 7 days	Approx. 7 days	Approx. 4 days
1 min	Approx. 10 days	Approx. 10 days	Approx. 10 days	Approx. 10 days

*1 LR8513, LR8514: 0.5 sec

Continuous operating time (BATTERY PACK Z1007)

Recording intervals	LR8510/LR8511
100 ms	Approx. 24 hours
1 min	Approx. 120 hours

*Use of the AC adapter is recommended when recording data over an extended period of time. (The Wireless Logging Station LR8410 operates using an AC adapter.)

Measurement units and wireless loggers have an operating temperature range of -20°C to 60°C.

Measurement units and wireless loggers can be used with confidence and peace of mind in hot environments such as the interior of a car during the summer as well as in cold-weather testing in the subzero temperatures of winter.



*The temperature range for recharging the Z1007 Battery Pack is 5°C to 35°C. For the operating temperature of the battery pack, batteries or current sensors, please refer to the specifications of each respective device.

Ensuring a safe measuring environment by closing doors

Distribution panels and control panels can be measured and data recorded safely by placing a measurement unit inside the enclosure, closing the door, and placing the LR8410 outside the enclosure.



Measurement unit:
Inside the distribution panel



LR8410:
Outside the distribution panel

Ensure peace of mind even in the event of a power outage or signal disruption.

Data is protected by a battery and backup function!

If the power goes out during measurement

If the Wireless Logging Station loses power

If the start backup setting is enabled, the instrument will resume measurement automatically when power is restored. If data is saved in real time to the SD memory card, the instrument's built-in high-capacity capacitor will maintain power until all data has been downloaded, making it extremely unlikely that data will be lost or the file system corrupted. Additionally, if a battery is installed while operating with the AC adapter, the logging station will automatically switch to battery power in the event of an outage.

If the measurement unit or wireless logger loses power

When power is restored, measurement will pick up where it left off. (Data for the outage period is assumed to have been lost.) The device will automatically switch power supplies if you install a battery pack (LR8510/LR8511) or LR6 alkaline batteries (LR8512 to LR8515) while using an AC adapter.

If communication is temporarily interrupted

Measurement units and wireless loggers have built-in buffer memory so that measurement data can be saved if communication is temporarily disrupted. This data is resent once communication is restored, allowing the measurement data to be stored in the Wireless Logging Station. For example, if 15 channels of data are measured at a recording interval of 1 second, data integrity can be preserved throughout a communication outage of up to about 72 minutes. Additionally, alarms can be output and emails sent to notify the operator in the event that communication is interrupted or the logging module's remaining battery life is low.



*Number of data points that can be stored in the internal memory: When recording n channels, (65,536/ n) data points

*Data collected using the logger utility is not restored during measurement. Load restored data that has been saved to an SD memory card or other media with the instrument.

Remote control from a computer via the HTTP/FTP server function



Download and automatically send data files and control instrument operation remotely without the need to install special application software on the computer.

Data acquisition via FTP	Download data files from the instrument's internal buffer memory, SD memory card, and USB memory stick to a computer. <i>Note: Waveform data cannot be downloaded from internal memory while measuring.</i>
Data transfer via FTP	Data files stored on the Wireless Logging Station's SD memory card or USB memory stick are automatically sent to an FTP server regularly while measurement is in progress or after measurement is complete.
Get notifications via E-mail	The Wireless Logging Station can send an e-mail message to a network-connected computer or mobile phone when a communications error occurs, when the any of the device's remaining battery life runs low, when the media or the internal memory is full, when a stop trigger occurs, and when an alarm occurs. E-mail messages can also be sent on a regular basis.
Remote control through HTTP server function	Using a Web browser, you can monitor screens and operate the instrument remotely, including to configure settings and download data. You can also perform configuration and measurement tasks using communications commands. <i>Note: Waveform data cannot be downloaded from internal memory while measuring.</i>



Recording data in real time on a computer Data collection software "Logger Utility"

By connecting a computer to the LR8410 using the instrument's USB or LAN interface, you can observe data in real time as it is recorded and scroll backwards through past waveform data.

Recording data in real time on an SD memory card

Waveform data collected wirelessly from measurement units and wireless loggers is recorded by the LR8410 on an SD memory card or USB flash drive at an interval of about 1 minute. (If the recording interval is longer than 1 minute, data is saved at the recording interval.)

Replace storage media during real-time recording

Storage media can be switched without stopping measurement. When the new media is inserted, any data remaining in the instrument's internal buffer memory is saved as a separate file.

Note: Although USB memory devices enable real-time saving of data, for more reliable data protection we recommend use of Hioki SD Memory Cards, which are guaranteed to work with the instrument, for real-time saving of data.

Maximum recording time

Recording 2 units (30 analog) (no alarm output or waveform processing)

Recording intervals	100 ms	200 ms	500 ms	1 s	2 s	5 s	10 s
LR8410 Internal memory(16 MB)	7h 46m	15h 32m	1d 14h 50m	3d 5h 40m	6d 11h 20m	16d 4h 21m	32d 8h 43m
SD Memory Card Z4001(2 GB)	41d 10h 12m	82d 20h 24m	207d 3h 1m	"★"	"★"	"★"	"★"

*Use only Hioki SD Memory Cards that are guaranteed to operate with the Wireless Logging Station for continuous long-term recording.

*Maximum recording time is inversely proportional to number of recording channels.

*Because the header portion of waveform files is not included in capacity calculations, expect actual maximum times to be about 90% of those in the table.

**★ exceeds 1 year.

Easy wireless setup

The LR8410 features Hioki's Quick Set function. Since measurement units can be registered simply by following the Unit Registration Guide, even first-time users can start measurement right away. It's also easy to configure settings when adding measurement units later.

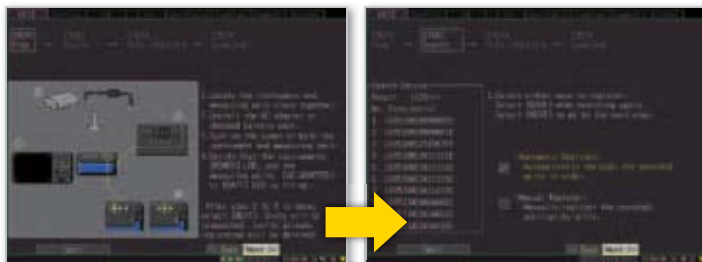

QUICK SET easy setup screen (shown when the Wireless Logging Station is turned on)

Logging modules within wireless range are automatically detected.

If no logging modules have been registered, the Quick Set screen is displayed when the LR8410 is turned on, and the instrument automatically detects any logging modules that are within communications range. Detected units are assigned to No. 1 through No. 7, and the registration process is completed. If one or more units have already been registered, the Wireless Logging Station automatically initiates a connection with the registered modules.



You can verify if the communications state between the LR8410 and detected units is good.

You can also assign a name to each unit for ID purposes. This feature helps you recognize where units are located when registering multiple units.

WIRELESS LOGGING STATION LR8410 (Product, accuracy guaranteed, and Post-adjustment accuracy guaranteed for 1 year)

General specifications	
Controllable devices	LR8510, LR8511, LR8512, LR8513, LR8514, LR8515
No. of controllable devices	Max. 7 units (up to 105 channels when used with the LR8510 or LR8511)
Control and communications (Between instrument and units)	Bluetooth® 2.1 + EDR (between Wireless Logging Station and logging modules); communication range: 30 m (line of sight), SSP security
Internal buffer memory	8 MWords volatile RAM (SDRAM)
Clock functions	Auto calendar, clock accuracy: ± 3 s/day (@23°C, 73.4°F)
Timebase accuracy	± 0.2 s/day while measuring (@23°C, 73.4°F)
Backup battery life	At least five years for clock and settings (@23°C, 73.4°F)
Operating temp. & humidity	-10 to 50°C (14 to 122°F), 30 to 80%RH or less (non-condensating)
Storage temp. & humidity	-20 to 60°C (-4 to 140°F), 80% RH or less (noncondensating)
Applicable standards	Safety: EN61010 EMC: EN61326 classA, EN61000-3-2, EN61000-3-3 Wireless certification: Japan (type : Incorporates a wireless module that has been certified certification) as compliant with applicable technical standards. US(FCC) : Part 15.247 (Contains FCC ID: QOQWT111A) Canada(IC) : RSS-210 (Contains IC: 5123A-BGTWT111A) EU : EN 300 328, EN 301 489-1, EN 301 489-17
Vibration endurance	JIS D 1601:1995 5.3(1), Category 1: Vehicle, Condition: Category A equiv.
External control terminal	External trigger input, trigger output, four alarm channel outputs, ground
Dimensions and Mass	230mm (9.06in)W × 125mm (4.92in)H × 36mm (1.42in)D, 700 g (24.7oz.) (excluding Battery Pack)
Accessories	Instruction manual × 1, Measurement guide × 1, SD Memory Card (2GB) Z4001 × 1, CD-R (data collection software "Logger Utility") × 1, USB cable × 1, AC Adapter Z1008 × 1
Data storage media	
SD memory card	SD standard-compliant × 1, Hioki Z4001 (2 GB), Data format: FAT16, FAT32
USB memory	Series A receptacle
Communication functions	
LAN Interface	IEEE802.3 Ethernet 100BASE-TX DHCP, DNS •Data acquisition and measurement criteria setting with the Logger Utility •Setting and measurement by communications commands •Manual file transfer by FTP server (from the instrument memory or removable storage). •Auto sending files by FTP client •Remote control by HTTP server •E-Mailing
USB Interface	USB2.0 compliant High Speed, Series-mini B receptacle • Data acquisition, condition settings used with the Logger Utility software (supplied as standard) • Configure the unit and measure using communication commands • Transfer data from the SD memory card to a PC via USB drive mode (data transfer not possible from USB memory sticks)
Display section	
Display	5.7 inch TFT color liquid crystal display (640 × 480 pixel), horizontal 16 division, vertical 10 division, selectable between English and Japanese displays, back light saver available
LCD Brightness	Selectable from 100, 70, 40, or 25 %
Power supplies	
AC adapter	Using the AC Adapter Z1008 (supplied as standard, 100 to 240 VAC, 50/60 Hz), Power consumption: 8 VA (with battery pack removed and maximum brightness)
Battery	Using the Battery Pack Z1007 (Li-ion 7.2V 2170mAh) (optional accessory, AC adapter has priority when used in combination with battery pack), continuous operation time: 3 hours (at 23 °C, LCD brightness 25 %) Fast recharging time: 7 hours (the AC Adapter or a 10 to 28 V DC external power supply can be connected while the Battery Pack Z1007 is installed.)
External power	10 to 28 VDC (Please contact your HIOKI distributor for connection cord) 15 VA (when battery is charged, and w/LCD max. blightness)
Trigger functions	
Trigger mode, timing	Modes : Single / Repeat, Timing : Start / Stop / Start & Stop, Logical sum (OR) and product (AND) of each trigger source, selectable for each channel
Analog signal source	Up to 105 channels, depending on how many Wireless Voltage/Temp Units LR8510 and Wireless Universal Units LR8511 are connected (U1-1 to U7-15). [Level trigger] Triggers when rising or falling through preset level [Window] Triggers when entering or exiting range defined by preset upper and lower limit values [Pattern trigger] Applies the trigger when a pattern defined in terms of 1, 0, x, and values is matched (Setting only available when using logic measurement with the LR8512)
Interval trigger	Set year, month, date, hour, minute and second (triggers when specified measurement interval is passed)
Trigger output	Open-drain output, Trigger output terminal: Push-button type terminal block (5 V voltage output, active low, pulse width: at least 100 ms) Output response time: Recording interval + 3 sec. or less (with 1 measurement unit, good communications) Recording interval + 5 sec. or less (with 7 measurement units, good communications)

Alarm output	
Number of channels	4 channels, non-isolated (common ground with chassis)
Alarm source	Analog input: Up to 105 channels, depending on how many Wireless Voltage/Temp Units LR8510 and Wireless Universal Units LR8511 are connected (U1-1 to U7-15). When thermocouple burn-out detection is enabled, when the Wireless Voltage/Temp Unit LR8510 or Wireless Universal Unit LR8511 battery is low, or when a communications error occurs
Alarm type	Level, window, output latch/ no latch, cancel alarm while measuring
Alarm sound	Buzzer, ON/OFF possible
Alarm output	Open drain output (with 5 V pull-up, active low), output response time: Recording interval + 3 sec. or less (with 1 measurement unit, good communications) Recording interval + 5 sec. or less (with 7 measurement units, good communications)
Output sink current	200 mA at 5 V to 30 VDC
Measurement settings	
Recording intervals (sampling period)	*1, *2100 ms, *2200 ms, 500 ms, 1 s, 2 s, 5 s, 10 s, 20 s, 30 s, 1 min, 2 min, 5 min, 10 min, 20 min, 30 min, 1 h (16 selections) All input channels are scanned at high speed during every recording interval *1 Setting not available when the thermocouple burnout detection setting is on. *2 The data update rate of the LR8513 and LR8514 is 500ms.
Recording length (time span)	Enable continuous recording ON (records until the Stop key is pressed), or continuous recording OFF (enable a specified time span)
Repeat measurement recording	Set Off or On. When On, measurement repeats at the set recording interval.
Display	
Time axis	200 ms to 1 day/divisions
Voltage axis	Select by position (magnification can be x100 to x1/2, 0 Position : Set between -50 to 150%) or upper/ lower limits
Waveform scrolling	Time-axis scrolling is available by left/right arrow keys while measuring and when measurement stops (waveform drawing period).
Jump function	Selects the displayed span of the waveform.
Monitor function	Confirm instantaneous values and waveforms without recording data.
Unit battery life remaining display	Displays the remaining battery life for wirelessly connected units as 1 of 3 levels.
Signal strength display	Displays the signal strength for wirelessly connected units as 1 of 3 levels.
Data saving	
Save destination	Select a SD memory card or USB memory (use only SD memory cards sold by Hioki).
Storage operation	Auto: Save waveform data or time divided calculation results in real time Manual: Push the save key (operation select: item choose/ directly save) Possible: Waveforms are saved approximately every one minute as binary or text data to the SD memory card or the USB memory (if sampling rate is slower than 1 minute, waveforms are saved at each interval)
Real-time saving	To the PC: Waveforms are saved to the HDD in the PC via LAN or USB communication when used with the Logger Utility Software. Data can be saved in real time to the SD memory card or USB memory at the same time.
Split save	Simple divide: Save waveform data at pre-set times into separate files from the time measurement starts. On schedule: Designate a reference time within 24 hours and save data into separate files at every set time interval starting from the reference time.
Overwriting save	Endless loop saving: New file overwrites the oldest file when the SD memory card or USB memory capacity runs short
Remove external media	Storage media may be removed during real-time save after message confirmation. Upon inserting the storage media again, data saved in internal memory during that time will be saved as a separate file in the media.
Data protection	If a power outage occurs or the battery runs out during real-time saving, power is cut off after the file is closed (protection becomes possible approximately 10 min. or more after the instrument is turned on).
Save types	Setting condition, waveform data (binary or text style), calculation of numerical value, screen data (compressed BMP), reservation settings
Reloading data	Stored binary data can be recalled by the logging station in 8 MB quantities
Calculation functions	
Numerical value calculations	Six calculations are available at the same time Average value, peak value, maximum value, time to maximum value, minimum value, time to minimum value
Data range of calculation	During measurement or after stopping: Applies calculations to all data in internal buffer memory, or to the time-span specified by A/B cursors. Interval calculation: Calculate values at pre-determined 1 sec to 1 day intervals and display the latest value
Calculation value save	Possible: After measuring the last calculated value is automatically saved to the SD memory card or USB memory as a text file Timed save: Save calculated data at pre-determined 1 sec to 1 day intervals as text data to the SD memory card or USB memory in real time.
Waveform calculations	Calculate sum, difference, product, and quotient between channels, with calculated results displayed as channels W1 to W30 (valid only while measuring, saved in real time with a channel's waveform data.).
Other functions	
Event marking	Search: Move to the event number entered and display the waveforms appearing before and after event Number of events: Maximum 1000 per measurement
A-B cursor	Measurement: Time difference between A/B cursors, measured value difference, cursor measured value, time Types: Select trace, vertical, or horizontal
Scaling	Convert and display the measurement value of each channel as a scaled value
Rate adjustment function	Scaling can be set for a channel so that its value is the same as that for UNIT1-CH1
Comment entry	Enter a title or a comment for each channel
Others	Start backup, save 5 types setting conditions into main unit, auto set up, start/stop key lock, key-lock, beep sound, schedule, Quick Set function

WIRELESS VOLTAGE/TEMP UNIT LR8510 / WIRELESS UNIVERSAL UNIT LR8511

Basic specifications (Product and accuracy guaranteed for 1 year)

No. of input channels	15 channels (select voltage or thermocouple for each channel) (Pt100/JPt100, resistance, and humidity are also selectable for each channel with the model LR8511)
Input terminals	[LR8510] M3 screw type terminal block (2 terminals per channel) [LR8511] Push-button terminals (4 terminals per channel)
Measurement objects	[LR8510] Voltage/ Thermocouple [LR8511] Voltage/ Thermocouple/ RTDs/ Resistance/ Humidity
Supported device	Wireless Logging Station LR8410-20
Control and communications	Bluetooth® 2.1+EDR (Communications range: 30 m, line of sight, security: SSP)
Backup memory	When recording n channels: (65,536/n) data points Data is maintained in the event of a communications error and resent when communications are restored.
Operating temperature and humidity	Temperature: -20°C to 60°C (-4 to 140°F) Humidity: -20°C to 40°C (-4 to 140°F) 80%RH or less (noncondensating) 40°C to 45°C (140 to 113°F) 60%RH or less (noncondensating) 45°C to 50°C (113 to 122°F) 50%RH or less (noncondensating) 50°C to 60°C (122 to 140°F) 30%RH or less (noncondensating) (temperature variation range is 5 to 35°C (41 to 95°F))
Storage temperature and humidity	Temperature: -20°C to 60°C (-4 to 140°F) Humidity: -20°C to 40°C (-4 to 140°F) 80%RH or less (noncondensating) 40°C to 45°C (140 to 113°F) 60%RH or less (noncondensating) 45°C to 50°C (113 to 122°F) 50%RH or less (noncondensating) 50°C to 60°C (122 to 140°F) 30%RH or less (noncondensating)
Input resistance	1 MΩ±5% (voltage and thermocouple measurement) 2 MΩ±5% (RTD and resistance measurement)
Maximum input voltage	±100 VDC
Max. inter-channel voltage	300 VDC (Channels are not isolated during resistance bulb, resistance, or humidity measurement.)
Maximum rated voltage to earth	300 VAC, DC
Digital filter	Select OFF/ 50 Hz/ 60 Hz (In order to remove harmonic components, during analog input the cut-off frequency is automatically set according to the sampling rate)
Applicable standards	Safety: EN61010
	EMC: EN61326 Class A, EN61000-3-2, EN61000-3-3
	Wireless certification Japan (type : Incorporates a wireless module that has been certified certification) as compliant with applicable technical standards. US(FCC) : Part 15.247 (Contains FCC ID: QOQWT111A) Canada(IC) : RSS-210 (Contains IC: 5123A-BGTWT111A) EU : EN 300 328 EN 301 489-1 EN 301 489-17
Vibration endurance	JIS D 1601:1995 5.3(I), Category 1: Vehicle, Condition: Category A equiv.
Dimensions and mass	Approx. 150W×90H×56D mm (5.91"W × 3.54"H × 2.2"D) (including cover), [LR8510] approx. 340 g (12.0 oz.), [LR8511] approx. 320 g (11.3 oz.)
Accessories	Instruction Manual x 1, AC Adapter Z1008 x 1, Bracket x 1

Power source	
AC adapter	AC Adapter Z1008 (bundled accessory, 12 VDC) 100 to 240 VAC, 50/60 Hz Typical power consumption: 1.0 VA (unit only)
Battery	Battery Pack Z1007 (Li-ion 7.2V 2170 mAh) (Option, the AC Adapter has priority when connected) Continuous operating time: Approx. 24 hours (with a recording interval of 100 ms, @23°C, 73.4°F) Approx. 120 hours (with a recording interval of 1 min., @23°C, 73.4°F) Charging time: Approx. 7 hours (@23°C, 73.4°F) The AC adapter or a 10 to 28 V DC external power supply can be connected while the Battery Pack Z1007 is installed.
External power	10 to 28 VDC Maximum rated power: 7 VA (when battery is charged)

LR8511 input specifications

Temperature Resistance Temperature Detector (RTD): Pt 100/JPt 100; connection: 3-wire/4-wire; measurement current: 1 mA
Ratings: JIS C1604-1997 and IEC 751 (Pt 100), JIS C1604-1989 (JPt 100)

Type	Range	Max. Resolution	Measurable Range	Measurement Accuracy
Pt 100	100 °C f.s.	0.01 °C	-100 to 100 °C	±0.6 °C
	500 °C f.s.	0.05 °C	-200 to 500 °C	±0.8 °C
	2000 °C f.s.	0.1 °C	-200 to 800 °C	±1.0 °C
JPt 100	100 °C f.s.	0.01 °C	-100 to 100 °C	±0.6 °C
	500 °C f.s.	0.05 °C	-200 to 500 °C	±0.8 °C
	2000 °C f.s.	0.1 °C	-200 to 500 °C	±1.0 °C

Resistance			
Range	Max. Resolution	Measurable Range	Measurement Accuracy
10 Ω f.s.	0.5 mΩ	0 to 10 Ω	±10 mΩ
20 Ω f.s.	1 mΩ	0 to 20 Ω	±20 mΩ
100 Ω f.s.	5 mΩ	0 to 100 Ω	±100 mΩ
200 Ω f.s.	10 mΩ	0 to 200 Ω	±200 mΩ

Humidity			
Range	Max. Resolution	Measurable Range	Measurement Accuracy
100 %rh f.s.	0.1 %rh	5.0 to 95.0 %rh	(See Humidity Accuracy Table)

Analog input section

(@ 23±5°C /73±9°F, 80% RH or less, Defined after zero-adjustment has been performed. The 50/60 Hz cut-off setting is selected)

Voltage

Range	Max. Resolution	Measurable Range	Measurement Accuracy
10 mV f.s.	500 nV	-10 mV to 10 mV	±10 μV
20 mV f.s.	1 μV	-20 mV to 20 mV	±20 μV
100 mV f.s.	5 μV	-100 mV to 100 mV	±100 μV
200 mV f.s.	10 μV	-200 mV to 200 mV	±200 μV
1 V f.s.	50 μV	-1 V to 1 V	±1 mV
2 V f.s.	100 μV	-2 V to 2 V	±2 mV
10 V f.s.	500 μV	-10 V to 10 V	±10 mV
20 V f.s.	1 mV	-20 V to 20 V	±20 mV
100 V f.s.	5 mV	-100 V to 100 V	±100 mV
1 - 5 V f.s.	500 μV	1 V to 5 V	±10 mV

Temperature(Thermocouples)

Type	Range	Max. Resolution	Measurable Range	Measurement Accuracy
K	100 °C f.s.	0.01 °C	-100 to 0 °C or less 0 to 100 °C	±0.8 °C ±0.6 °C
	500 °C f.s.	0.05 °C	-200 to -100 °C or less -100 to 0 °C or less 0 to 500 °C	±1.5 °C ±0.8 °C ±0.6 °C
J	2000 °C f.s.	0.1 °C	-200 to -100 °C or less -100 to 1350 °C	±1.5 °C ±0.8 °C
	100 °C f.s.	0.01 °C	-100 to 0 °C or less 0 to 100 °C	±0.8 °C ±0.6 °C
E	500 °C f.s.	0.05 °C	-200 to -100 °C or less -100 to 0 °C or less 0 to 500 °C	±1.0 °C ±0.8 °C ±0.6 °C
	2000 °C f.s.	0.1 °C	-200 to -100 °C or less -100 to 0 °C or less 0 to 1000 °C	±1.0 °C ±0.8 °C ±0.6 °C
T	100 °C f.s.	0.01 °C	-100 to 0 °C or less 0 to 100 °C	±0.8 °C ±0.6 °C
	500 °C f.s.	0.05 °C	-200 to -100 °C or less -100 to 0 °C or less 0 to 400 °C	±1.5 °C ±0.8 °C ±0.6 °C
N	2000 °C f.s.	0.1 °C	-200 to -100 °C or less -100 to 0 °C or less 0 to 400 °C	±1.5 °C ±0.8 °C ±0.6 °C
	100 °C f.s.	0.01 °C	-100 to 0 °C or less 0 to 100 °C	±1.2 °C ±1.0 °C
R	500 °C f.s.	0.05 °C	-200 to -100 °C or less -100 to 0 °C or less 0 to 500 °C	±2.2 °C ±1.2 °C ±1.0 °C
	2000 °C f.s.	0.1 °C	-200 to -100 °C or less -100 to 0 °C or less 0 to 1300 °C	±2.2 °C ±1.2 °C ±1.0 °C
S	100 °C f.s.	0.01 °C	0 to 100 °C	±4.5 °C
	500 °C f.s.	0.05 °C	100 to 300 °C or less 300 to 500 °C 300 to 1700 °C	±4.5 °C ±3.0 °C ±2.2 °C
B	2000 °C f.s.	0.1 °C	0 to 100 °C or less 100 to 300 °C or less 300 to 1700 °C	±4.5 °C ±3.0 °C ±2.2 °C
	100 °C f.s.	0.01 °C	0 to 100 °C	±1.8 °C
W	500 °C f.s.	0.05 °C	0 to 500 °C	±1.8 °C
	2000 °C f.s.	0.1 °C	0 to 2000 °C	±1.8 °C

Reference junction compensation: Internal/ External, at INT RJC, total accuracy = add ± 0.5 °C
Thermocouple burn-out detection: Enable/disable thermocouple burn-out detection at each recording interval.(The burnout detection setting cannot be used with a recording interval of 100 ms.)

■ Humidity Sensor Z2000 accuracy

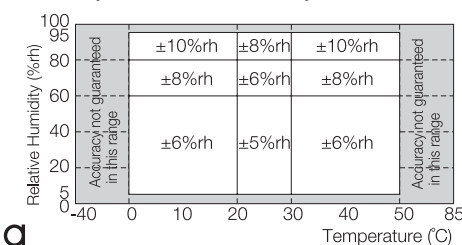

■ Option



Wireless Loggers LR8512, LR8513, LR8514, LR8515

Shared specifications

Control and communications	Bluetooth® 2.1+EDR (Communications range: 30 m, line of sight, security: SSP)
Internal memory	Nonvolatile memory (Flash memory)
Storage capacity	500,000 data items for each channel
Standard compliance	Same as Wireless Logging Station LR8410
Functions	Alarm, Scaling, Recording operation hold function, Erroneous operation prevention, Comment recording function, Energy saving function, Authentication function, Free Run (excluding LR8512)
Vibration endurance	JIS D 1601:1995 5.3(I), Category I: Vehicle, Condition: Category A equiv.
Operating temperature and humidity	Temperature: -20 to 60 °C (-4 to 140 °F), Humidity: 80%rh or less (non-condensing) (Depends on battery and current sensor specifications when they are in use)
Power supplies	AC Adapter Z2003 (sold as a separate option), LR6 alkaline batteries × 2, 5 to 13.5 VDC external power source
Accessories	CD-R (Instruction Manual, Logger Utility) × 1, Measurement Guide × 1, Caution for Using Radio Waves × 1, AA alkaline batteries (LR6) × 2 Note: Only included with the LR8512: Connection Cable L1010 × 2

WIRELESS PULSE LOGGER LR8512

Basic specifications (Accuracy guaranteed and Post-adjustment accuracy guaranteed for 1 year)

No. of input channels	2 channels (common GND)
Measurement modes	Integrating (cumulative/Instant), Revolution, Logic (Records an I/O for each recording interval)
Measurement ranges (Resolution)	Totalization: 1000M pulse f.s. (1 pulse) No. of revolutions: 5000/n[r/s]f.s. (1/n[r/s]) *n is the number of pulses, 1 to 1000, per revolution.
Supported input format	Non-voltage "a" contact (always-open contact point), open collector, or voltage input (DC 0 V to 50 V)
Recording intervals	0.1 to 30 sec, 1 to 60 min, 16 selections
Recording modes	Instantaneous value
Dimensions	85W×61H×31D mm (3.35W×2.40H×1.22D in)
Mass	95 g (Not including the battery)

WIRELESS CLAMP LOGGER LR8513

Basic specifications (Accuracy guaranteed and Post-adjustment accuracy guaranteed for 1 year)

No. of input channels	2 channels (common GND)
Measurement items	AC load current, DC load current AC leak current (using current sensor)
Effective value calculation	Software calculates the true RMS value
Measurement ranges	AC500.0 mA to 2000 A (By current sensor) DC10.00 A to 2000 A (By current sensor) *Current and leak current that occur intermittently cannot be measured.
Measurement accuracy	±0.5% rdg. ±5 dgt. (DC, AC 50/60 Hz) *Add the sensor's accuracy when the current sensor is connected (Page 12)
Recording intervals	0.5 to 30 sec, 1 to 60 min, 14 selections
Recording modes	Instantaneous value, average value, Maximum value recording
Dimensions	85W×75H×38D mm (3.35W×2.95H×1.50D in)
Mass	130 g (Not including the battery)

Sensor used	Range	Max. Resolution	Measurable Range
9675	500.0 mA	0.1 mA	AC 1.0 mA to 500.0 mA
	5.000 A	0.001 A	AC 0.010 A to 5.000 A
9657-10	500.0 mA	0.1 mA	AC 1.0 mA to 500.0 mA
	5.000 A	0.001 A	AC 0.010 A to 5.000 A
9695-02	5.000 A	0.001 A	AC 0.010 A to 5.000 A
	50.00 A	0.01 A	AC 0.10 A to 50.00 A
CT6500	50.00 A	0.01 A	AC 0.10 A to 50.00 A
	500.0 A	0.1 A	AC 1.0 A to 500.0 A
9669	1000 A	1 A	AC 10 A to 1000 A
CT9691-90 CT7631/ CT7731	10.00 A	0.01 A	AC 0.10 A to 10.00 A DC± (0.10 A to 10.00 A)
	100.0 A	0.1 A	AC 1.0 A to 100.0 A DC± (1.0 A to 100.0 A)
CT9692-90 CT7636/ CT7736	20.00 A	0.01 A	AC 0.10 A to 20.00 A DC± (0.10 A to 20.00 A)
	200.0 A	0.1 A	AC 1.0 A to 200.0 A DC± (1.0 A to 200.0 A)
CT9693-90 CT7642/ CT7742	200.0 A	0.1 A	AC 1.0 A to 200.0 A DC± (1.0 A to 200.0 A)
	2000 A	1 A	AC 10 A to 2000 A DC± (10 A to 2000 A)
CT9667-01/-02/-03	500.0 A	0.1 A	AC 1.0 A to 500.0 A
	5000 A	1 A	AC 10 A to 5000 A
CT7044/ CT7045/ CT7046	50.00 A	0.01 A	AC 0.10 A to 50.00 A
	500.0 A	0.1 A	AC 1.0 A to 500.0 A
	5000 A	1 A	AC 10 A to 5000 A

WIRELESS HUMIDITY LOGGER LR8514

Basic specifications

*Only the temperature and humidity sensors affect the measurement accuracy and are subject to calibration. The LR8514 logger does not require calibration.

No. of input channels	2 ch for temperature + 2 ch for humidity (2 sensors can be attached)
Measurement items	Temperature, humidity
Temperature measurement accuracy	±0.5°C (10°C to 60°C), using Z2010/Z2011 If outside above temperature range: Add 0.015°C/°C (-40°C to 10°C) or 0.02°C/°C (60°C to 80°C)
Humidity measurement accuracy	±3% RH (20°C to 30°C, 20% to 90% RH) If outside above range, see Figure 1.
Recording intervals	0.5 to 30 sec, 1 to 60 min, 14 selections
Recording modes	Instantaneous value
Dimensions	85W×61H×31D mm (3.35W×2.40H×1.22D in)
Mass	95 g (Not including the battery)

Measurement objects	Range	Max. Resolution	Measurable Range
Temperature	100 °C f.s.	0.1 °C	-40 °C to 80 °C
Humidity	100%rh f.s.	0.1 %rh	0 to 100 %rh

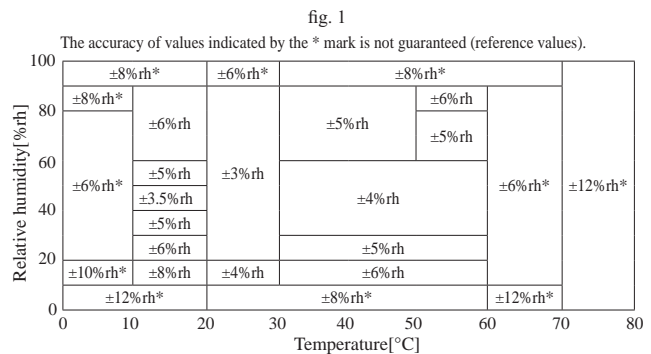

WIRELESS VOLTAGE/TEMP LOGGER LR8515

Basic specifications (Accuracy guaranteed and Post-adjustment accuracy guaranteed for 1 year)

No. of input channels	2 ch (isolated; select voltage of thermocouple for each channel)
Measurement items	Voltage/Thermocouple (K, T)
Input terminals	M3 screw type terminal block (2 terminals per channel)
Measurement ranges	Voltage: 50 mV/500 mV/5 V/50 V Thermocouple: 1000°C (1832°F)
Maximum input voltage	DC±50 V
Max. inter-channel voltage	DC 70 V
Recording intervals	0.1 to 30 sec, 1 to 60 min, 16 selections
Recording modes	Instantaneous value
Dimensions	85W×75H×38D mm (3.35W×2.95H×1.50D in)
Mass	126 g (Not including the battery)

Measurement objects	Type	Range	Max. Resolution	Measurable Range	Measurement Accuracy
Voltage		50 mV f.s.	0.01 mV	-50 mV to 50 mV	±0.05 mV
		500 mV f.s.	0.1 mV	-500 mV to 500 mV	±0.5 mV
		5 V f.s.	1 mV	-5 V to 5 V	±5 mV
		50 V f.s.	10 mV	-50 V to 50 V	±50 mV
Thermocouples	K	1000 °C f.s.	0.1 °C	-200 °C to -100 °C	±1.5 °C
				-100 °C to 999.9 °C	±0.8 °C
	T	1000 °C f.s.	0.1 °C	-200 °C to -100 °C	±1.5 °C
				-100 °C to 0 °C	±0.8 °C
				0 °C to 400 °C	±0.6 °C

Reference contact compensation: Switchable between internal and external

Reference contact compensation accuracy: ±0.5°C (When using internal compensation, add to thermocouple measurement accuracy.)

Temperature characteristics: Add (measurement accuracy × 0.1)/°C to measurement accuracy.



Logger Utility specifications

Bundled application software(CD-R)

Supported units	Model 8423, 8430, LR8431, LR8432, LR8400, LR8401, LR8402, and LR8410	Data conversion	Target data: Real-time data acquisition file (LUW format), record to internal memory data (MEM format) Converted sections: All data, designation section Format: CSV format (separate by comma, space, tab), transfer to Excel spreadsheet, arbitrary data thinning
Operating environment	Windows 10/8/7 (32bit/64bit), Vista (32bit/64bit), XP SP2 or later (32bit)	Waveform processing	Processing items: Four arithmetic operations Number of processing channels: 60 channels
Real-time data acquisition	Measurements on multiple loggers connected by LAN or USB can be controlled to sequentially acquire, display and save waveform data (for recording up to 10 million samples) Number of controllable instruments: up to 5 units (This software is compatible only with the LR8410, LR8400 series, LR8431, 8423, and 8430) Display: Waveforms (time-axis divided display possible), numerical values (logging), and alarm status can be displayed at the same time Numerical value display: Can be monitored in a separate window Scroll: Waveform scroll while measuring Data saving destination: Real-time data transfer to Excel, or Real-time data acquisition file (LUW format) Event marks: Can be set while measuring	Parameter calculations	Target data: Real-time data acquisition file (LUW format), record to internal memory data (MEM format), data acquired in real time, waveform processing data Calculation items: Average, peak, maximum values, time to maximum values, minimum values, time to minimum values, ON time, OFF time, count the number of ON time and OFF time, standard deviation, integration, area values, totalization
Data acquisition settings	Data acquisition settings for the logger or logging station Saving: The setting for multiple loggers or logging stations can be saved together in one file (LUS format); Instrument configuration settings can be sent and received	Search functions	Target data: Real-time data acquisition file (LUW format), record to internal memory data (MEM format) Search mode: Event mark, time and date, maximum position, minimum position, maximum pole, minimum pole, alarm position, level, window, amount of change
Waveform display	Processed data file: Real-time data acquisition file (LUW format), Record to internal memory data (MEM format) Display format: Simultaneously display waveform and numerical value, (time-axis divided display possible) Maximum number of channels: 675 channels (measurement data) + 60 channels (waveform processing data) Others: Display each channel's waveform on 10 sheets, scroll, record event mark, cursor, screen hard copy, numerical value display	Print functions	Supported printer: Printer compatible with the OS Target data: Real-time data acquisition file (LUW format), record to internal memory data (MEM format) Print format: Waveform image, report format, list print (channel settings, event, cursor value) Print area: The entire area, area between cursors A and B Print preview: Supported



Model : WIRELESS LOGGING STATION LR8410

Model No. (Order Code) (Note)

LR8410-20 (English model, main unit only)

Accessories: Instruction manual ×1, Measurement guide ×1, SD Memory Card (2GB) Z4001 ×1, CD-R (data collection software "Logger Utility") ×1, USB cable ×1, AC Adapter Z1008 ×1

Measurement cannot be performed using the LR8410 alone. Measurement requires an LR8510/LR8511 measurement unit or an LR8512 or other wireless logger series. (One LR8410 can control from one to seven units [different models can be mixed].)

Measurement units



Model : WIRELESS VOLTAGE/TEMP UNIT LR8510

Model No. (Order Code) (Note)

LR8510 (For the LR8410)

Model LR8510/ LR8511/ LR8410 Shared bundled accessory: AC ADAPTER Z1008



Model : WIRELESS UNIVERSAL UNIT LR8511

Model No. (Order Code) (Note)

LR8511 (For the LR8410)

An optional AC adapter for the LR8512 to LR8520 is available for separate purchase.

Wireless loggers



Model : WIRELESS PULSE LOGGER LR8512

Model No. (Order Code) (Note)

LR8512 (2 ch)

For pulse count, rotation, I/O signal measurement, LI010 cable bundled



Model : WIRELESS CLAMP LOGGER LR8513

Model No. (Order Code) (Note)

LR8513 (2 ch)

For AC/DC load current, AC leak current measurement, sensor is sold separately



Model : WIRELESS HUMIDITY LOGGER LR8514

Model No. (Order Code) (Note)

LR8514 (2 ch)

2 ch Temperature/ 2 ch Humidity measurement, sensor is sold separately



Model : WIRELESS VOLTAGE/TEMP LOGGER LR8515

Model No. (Order Code) (Note)

LR8515 (2 ch)

Voltage / Thermocouple (K, T) measurement, sensor is sold separately



*Please see the individual product catalog for more information



Model : WIRELESS FUNGAL LOGGER LR8520

Model No. (Order Code) (Note)

LR8520

Record fungal index, growth prediction, alarm 1 channel, temperature measurement, humidity sensor is sold separately



Collect data on your tablet !

Use your tablet*, smart-phone*, or PC via Bluetooth® to collect data from Wireless Mini Loggers. (*Android™ only)
Transfer data even during recording, or check data and fluctuating waveforms on the spot.

Options for the Wireless Logging Station LR8410

Bundled Accessory	 AC ADAPTER Z1008 100 to 240V AC	 SD MEMORY CARD 2GB Z4001 For storing measurement data	 BATTERY PACK Z1007 Li-ion, Charges while installed, 7.2V/2170mAh	 CARRYING CASE C1007 Holds one LR8410 and four measurement units	 FIXED STAND Z1009 For wall hanging and slanted bench mounting	 LAN CABLE 9642 Straight Ethernet cable, supplied with straight to cross conversion adapter, 5 m (16.41 ft) length
-------------------	---	---	--	---	---	---

Shared options for the LR8510/ LR8511

Bundled Accessory	 AC ADAPTER Z1008 100 to 240V AC	 BATTERY PACK Z1007 Li-ion, Charges while installed, 7.2V/2170mAh	 Thermocouple For reference only. Please purchase locally.
	*AC adapter is bundled with the LR8510/8511		

Options for the LR8511

 HUMIDITY SENSOR Z2000 3 m (9.84 ft) length
--



Shared options for the LR8512/ LR8520

Bundled Accessory	 CONNECTION CABLE L1010 1.5 m (4.92 ft) length
	*L1010 is bundled with the LR8512/8520



















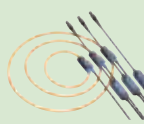

Shared options for the LR8514/ LR8520

 HUMIDITY SENSOR Z2010 50 mm (1.97 in) length	 HUMIDITY SENSOR Z2011 1.5 m (4.92 ft) cord length
--	---

Options for the LR8515

 Thermocouple For reference only. Please purchase locally.	
--	---

Current Sensor Options for the LR8513

 CLAMP ON SENSOR CT6500 500 A AC, ϕ 46 mm (1.81 in)	 CLAMP ON SENSOR 9669 1000 A AC, ϕ 55 mm (2.17 in)	 CLAMP ON SENSOR 9695-02 50 A AC, ϕ 15 mm (0.59 in), Not CE marked	 CONNECTION CABLE 9219 Connect with the 9695-02	 CLAMP ON LEAK SENSOR 9657-10 *5 A AC, ϕ 40 mm (1.57 in) *Using with LR8513	 CLAMP ON LEAK SENSOR 9675 *5 A AC, ϕ 30 mm (1.18 in) *Using with LR8513	 AC FLEXIBLE CURRENT SENSOR CT9667-01/-02/-03 ϕ 100/ 180/ 254 mm (3.94/ 7.09/ 10.00 in)		
 AC/DC AUTO-ZERO CURRENT SENSOR CT7731 100 A AC/DC, ϕ 33 mm (1.30 in) CT7736 *200 A AC/DC, ϕ 33 mm (1.30 in) CT7742 2000 A AC/DC, ϕ 55 mm (2.17 in) *Using with LR8513	 AC/DC CURRENT SENSOR CT7631 100 A AC/DC, ϕ 33 mm (1.30 in) CT7636 *200 A AC/DC, ϕ 33 mm (1.30 in) CT7642 2000 A AC/DC, ϕ 55 mm (2.17 in) *Using with LR8513	 AC FLEXIBLE CURRENT SENSOR CT7044 *5000 A AC, ϕ 100 mm (3.94 in) CT7045 *5000 A AC, ϕ 180 mm (7.09 in) CT7046 *5000 A AC, ϕ 254 mm (10.00 in) *Using with LR8513	 OUTPUT CORD L9095 Connect to BNC terminal, 1.5 m (4.92 ft) length, for the CM7290 or other					
 DISPLAY UNIT CM7290, CM7291 For CT7000 series, CM7291 with built-in Bluetooth® wireless technology	 Use the CT7000 series Current Sensors with the Display Unit and Output Cord to generate output for a data logger, or other instrument.	<h3>Shared Options for the LR8512 to LR8520</h3> <table border="1"> <tr> <td> AC ADAPTER Z2003 100 V to 240 VAC</td> <td> MAGNETIC STRAP Z5004</td> <td> MAGNETIC STRAP Z5020 Strong Magnetic force type</td> </tr> </table>				 AC ADAPTER Z2003 100 V to 240 VAC	 MAGNETIC STRAP Z5004	 MAGNETIC STRAP Z5020 Strong Magnetic force type
 AC ADAPTER Z2003 100 V to 240 VAC	 MAGNETIC STRAP Z5004	 MAGNETIC STRAP Z5020 Strong Magnetic force type						

Use of the Wireless Logging Station

The LR8510/ LR8511 measurement units, the LR8512/ LR8513/ LR8514/ LR8515/ LR8520 wireless loggers, and the LR8410 Wireless Logging Station use the 2.4 GHz band. No radio station license is required in order to use these products, but the following precautions should be observed:

- Do not use with systems required to exhibit a high level of safety or reliability.
- Do not use in proximity to pacemakers or other medical devices.
- The communications range between the Wireless Voltage/ Temp Unit, Wireless Universal Unit, and Wireless Logging Station is 30 meters (line-of-sight distance). The presence of obstructions (such as walls or metal shielding) may compromise the reliability of communications or shorten the communications range.
- When used in proximity to other devices that use the same frequency band, for example wireless networking devices, transmission and reception of data may become unreliable, and product operation may be affected by the other devices.
- Although communications with the LR8510/ LR8511 measurement units, the LR8512/ LR8513/ LR8514/ LR8515/ LR8520 wireless loggers, and the LR8410 Wireless Logging Station are encrypted using SSP, the confidentiality of information sent and received in this manner is not guaranteed. Hioki is not liable for any damage sustained due to the interception of measured values sent using wireless communications.
- The LR8510/ LR8511 measurement units, the LR8512/ LR8513/ LR8514/ LR8515/ LR8520 wireless loggers, and the LR8410 Wireless Logging Station emit radio waves. Use of radio waves is subject to licensing requirements in certain countries. Use in countries or regions other than those listed above may constitute a violation of law, exposing the operator to legal penalties.

*The Bluetooth® word mark and logos are registered trademarks owned by Bluetooth SIG, Inc. and any use of such marks by HIOKI E.E. CORPORATION is under license.

Note: Company names and Product names appearing in this catalog are trademarks or registered trademarks of various companies.

HIOKI
HIOKI E. E. CORPORATION

HIOKI

MEMORY HILOGGER LR8400, LR8401, LR8402



Portable Data Logger with 30 Standard Channels Expandable to 60 Channels

Only the size of an A4 sheet of paper, the HIOKI LR8400-20 Series is the realization of our goal to build a logger that provides the existing functionality of a multi-channel data logger in a portable format. The new model comes with 30 channel capability as standard, to which another 30 channels can be added. All input channels for measuring temperature (with thermocouples), or voltage are isolated for safety, culminating in a powerful multi-measurement system that also offers pulse and logic inputs. Long-term logging is coupled with the capability to protect data against unexpected power outages and other problems for stable recordings over an entire year (see note).

Note: Continuous recordings lasting longer than 1 year are also possible.

CE

asita
TECNOLOGIE DI MISURA

In fuel cell, electric automobile and other development

Provides assistance with

- Environmental measurements to prevent global warming
- Development of fuel cell materials, energy field
- Development of automobiles, testing of automobile parts
- Maintenance and inspection of equipment
- Monitoring plants
- Testing of electrical products
- Impedance testing of electronic parts

Multi-channel measurements

In the development of fuel cells, multiple power-generating cells are connected to form a stack. Independent measurements of each cell require multi-channel measurements of DC voltage, DC current, temperature and other parameters.

The LR8400-20 Series comes with 30 channels as standard, which can be expanded to 60 channels.

High withstand voltage

The HiLOGGER measures not only fuel cells, but also batteries for UPS (uninterruptible power supplies) devices used in buildings as well as batteries consisting of cells and packaging connected in stacks that require multi-point measurements.

In such measurements, high voltage for the whole stack is applied between channel-to-channel and channel-to-ground. Only a measuring instrument with isolated inputs and high-capacity withstand voltage characteristics can endure this.

Note: Isolation between channels is possible through the use of semi-conductor relays. Voltage exceeding the product specifications, such as that originating from lightning surges or other sources, should never be applied between each channel; otherwise the relays will short and the recorder will be damaged.

High-speed sampling

In the development of automobiles such as electric vehicles (EV) and plug-in hybrid vehicles (PHV) that use motors for propulsion, abrupt changes in load need to be measured.

This makes the multi-channel, high-speed 10 ms sampling capability of the LR8400-20 Series an indispensable feature.

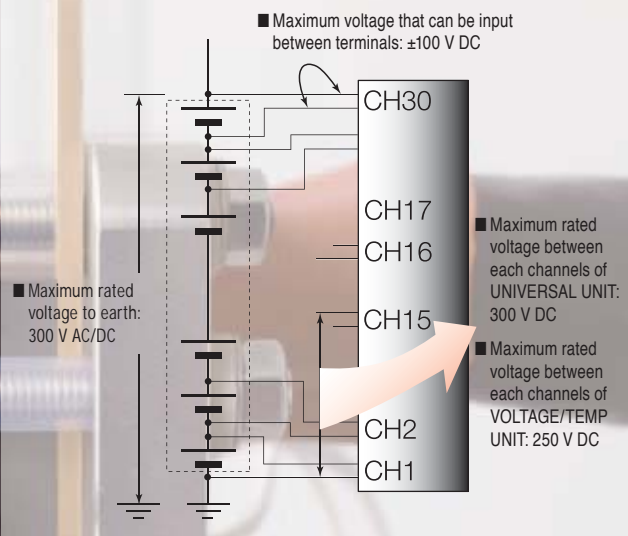

Highlights

Multi-measurements

Measure and record:

- Temperature & humidity
- A variety of transducer outputs (DC voltage)
- Resistance values

Also comes with high withstand voltage; isolated inputs required when measuring and recording battery cell voltages

Voltage measurement (DC only)

- 30 input channels

Note: The LR8400-20, LR8401-20 and LR8402-20 models differ in the combination of input functions and terminals.

- All input channels are isolated

Note: Maximum rated voltage above ground between the HiLOGGER and analog inputs is 300 V AC/DC.

Note: Maximum channel-to-channel voltage is a high voltage of 300 V DC. (Maximum voltage for models with M3 screw input terminals is 250 V DC.)



Temperature & humidity measurement

- Temperature measurements of thermocouples on 30 channels
- M3 screw terminal inputs enable secure connection of even thin thermocouples
- Special sensor permits humidity measurements on 30 channels (optional Z2000)

Note: The sensor power supply is the M3 mm dia. screw terminal block on the left side. Note: Both universal input terminals and M3 mm dia. input terminals enable humidity measurements.

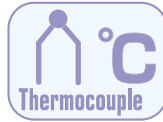

Temperature & resistance measurement

- Universal inputs support temperature measurements using Platinum resistance temperature sensor (Pt100/ JPt100), or resistance measurements (four wires)

Note: These cannot be measured using the M3 screw input terminals units.

Note: Supports resistance recording to enable assessment of changes in resistance in the device under test. 4-terminal method, measurement resolution 0.5 mΩ - testing current 1 mA

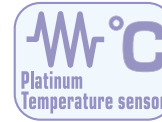

To record 4 - 20mA instrumentation signals, attach a commercially available 250Ω shunt resistance to the input terminals (between + and -) to convert the signals to 1 - 5 V. Then use the 1-5V or the 10V f.s. input range in the HiLOGGER.

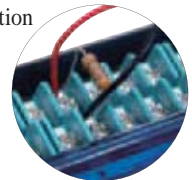

■ **A compact A4 size enhances mobility**

A compact A4 size footprint makes it ideal for use in virtually any environment.

■ **Helps also in collecting automotive data**

Ideal for testing and collecting data on the vibration characteristics of automotive parts



Pulse totalization measurement

- 8 channel inputs (pulse and digital input selectable for each channel)
- For measuring energy consumption and cumulative flow

• The input signal shares common ground with the HiLOGGER
Note: M3 screw input terminals provide direct connection



Pulse rotations measurement

- 8 channel inputs (pulse and digital input selectable for each channel)
- For measuring rotational irregularities of motors and drills

• The input signal shares common ground with the HiLOGGER
Note: M3 screw input terminals provide simple connection



Logical 1-0 measurement

- 8 channel inputs (digital and pulse input selectable for each channel)
- 1 or 0 is recorded for each recording interval

• The input signal shares common ground with the HiLOGGER
Note: M3 screw input terminals provide simple connection

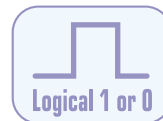

Accurately capture any phenomena you want to measure

Highlights

High-speed Recording

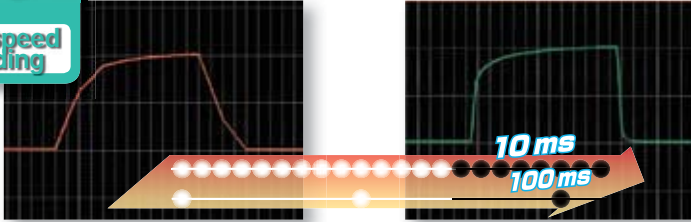

Sampling at 100 ms intervals cannot capture abrupt load changes

Sampling the same waveform at ten times the speed, at 10 ms intervals, accurately captures the changes.

■ 10 ms high-speed sampling

The development of hybrid and electric automobiles requires instruments that can measure abrupt load changes. Channels 1 to 15 provide 10-ms sampling and channels 16 to 30 provide 20-ms sampling. These channels allow you to track waveforms not possible with earlier models.

Note: Measurements on channels 31 to 60 provide 50-ms sampling.

Highlights

Noise suppression

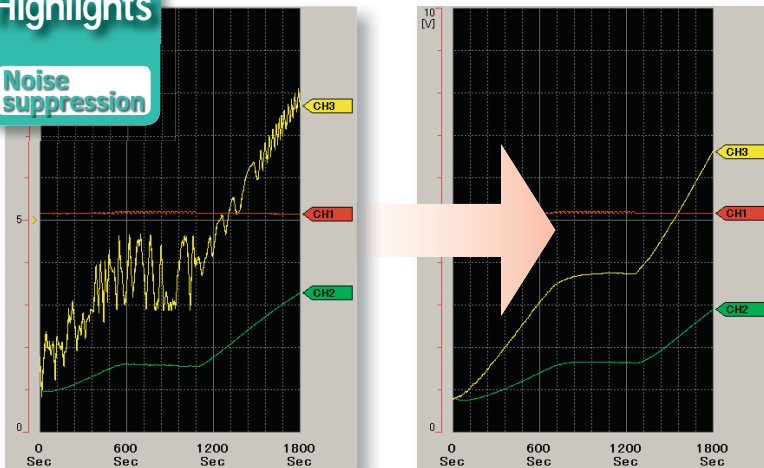

Without electric noise reduction, you will obtain a waveform like the one above in temperature measurements of an electromagnetic cooker

A digital filter in the HiLOGGER eliminates high-frequency noise to enable accurate temperature waveforms

■ Enhanced noise suppression

A digital oversampling filter function reduces inverter switching noise and 50/60 Hz hum noise, a concern in earlier models, during recording.

Note: The noise reduction effect improves with longer recording intervals (i.e., at slower sampling speeds).

Highlights

Easy-to-view LCD



■ 5.7 inch TFT LCD display is easy to view even at an angle

The LCD has a wider visual angle and is larger (5.7 inches, 640 × 480 dots)

than the STN LCD in our previous model (8420-51s) to facilitate observation of waveforms on multiple channels.

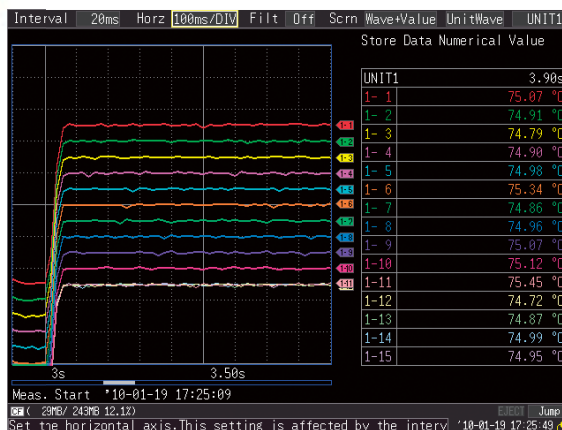

Store data securely for more than 1 year

Highlights
Storage Media



Compatible with USB memory devices

For even greater convenience, the HiLOGGER now provides support for USB memory devices. Measurements can now immediately be written to a USB memory device in real-time. USB memory devices are also a handy means to transfer data to a PC.

Note: Although USB memory devices enable real-time saving of data, for more reliable data protection we recommend use of HIOKI CF cards, which are guaranteed to work with the instrument, for real-time saving of data.



Saving data to CompactFlash (CF) card

Use only HIOKI CF cards, which are manufactured to strict industrial standards, for long-term storage of important data.

Note: Operation of non-HIOKI CF cards is not guaranteed

Recording Capacity

Note: Use only HIOKI CF cards that are guaranteed to operate with the HiLOGGER for continuous long-term recording.

Recording intervals	Recording of 15 analog channels only (no pulse measurement, alarm output or waveform processing data)			
	Internal memory (16 MB)	Model 9728 (512 MB)	Model 9729 (1 GB)	Model 9830 (2 GB)
10 ms * * For 15 or fewer analog channels	1h 33m	2d 01h 42m	4d 03h 25m	8d 06h 50m
Recording intervals	Recording of 30 analog channels only (no pulse measurement, alarm output or waveform processing data)			
	Internal memory (16 MB)	Model 9728 (512 MB)	Model 9729 (1 GB)	Model 9830 (2 GB)
20 ms * * For 30 or fewer analog channels	1h 33m	2d 01h 42m	4d 03h 25m	8d 06h 50m
50ms	3h 53m	5d 04h 16m	10d 08h 33m	20d 17h 06m
100ms	7h 46m	10d 08h 33m	20d 17h 06m	41d 10h 12m
200ms	15h 32m	20d 17h 06m	41d 10h 12m	82d 20h 24m
500ms	1d 14h 50m	51d 18h 45m	103d 13h 30m	207d 03h 01m
1s	3d 05h 40m	103d 13h 30m	207d 03h 01m	414d 06h 03m
2s	6d 11h 20m	207d 03h 01m	414d 06h 03m	"★"
5s	16d 04h 21m	517d 19h 34m	"★"	"★"
10s	32d 08h 43m	"★"	"★"	"★"
20s	64d 17h 26m	"★"	"★"	"★"
30s	97d 02h 10m	"★"	"★"	"★"
1min	194d 04h 20m	"★"	"★"	"★"
2min	388d 08h 40m	"★"	"★"	"★"
5min to 1hour	"★"	"★"	"★"	"★"

- Maximum recording time is inversely proportional to number of recording channels.
- Because the actual capacity of a CF card is less than that indicated, and because the header portion of waveform files is not included in capacity calculations, expect actual maximum times to be about 90% of those in the table.
- "★" exceeds 1 year.

Highlights
Replacing cards



Cards can be replaced during real-time recording

This function has been provided to enable removal of cards during recording to allow the user to analyze the data recorded so far. This makes it possible to replace USB memory devices and CF cards during real-time recording without having to stop measurements.

Note: During high-speed recording, be sure to insert the new storage media within 2 minutes of removing a card.

A host of useful functions and features



- VOLTAGE/TEMP UNIT LR8500**
- 15ch
 - M3 screw terminals (2 terminals per channel)
- UNIVERSAL UNIT LR8501**
- 15ch
 - Push-button type terminals (4 terminals per channel)



■ Up to two additional 15 channel input units can be added

The need for more measurement channels can be met even after purchasing the instrument. The instrument comes with 30 channels as standard, but another two 15 channel input units can be added to expand the total number of channels to 60.

Note: The units provided with the unit as standard cannot be removed.

The number of input channels
can be expanded!!
Max. 60 ch



Function highlights

Ease of use

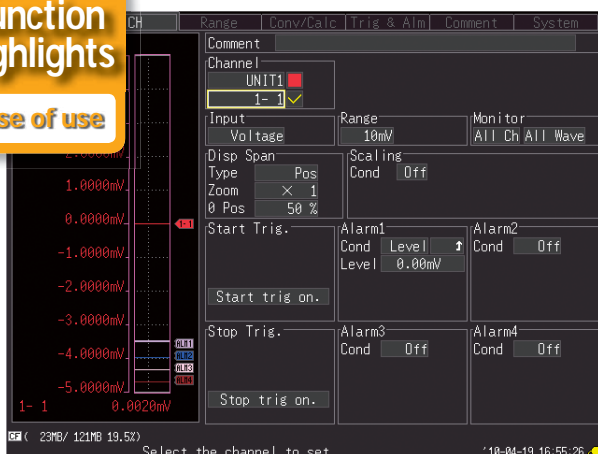

■ Input setting screens with waveform monitoring

The HiLOGGER adopts the setting screens that earned its sister model (8430-20) a reputation for user-friendliness. Range settings, warnings, triggers, waveform processing and other measurement input settings can be taken in at a glance.

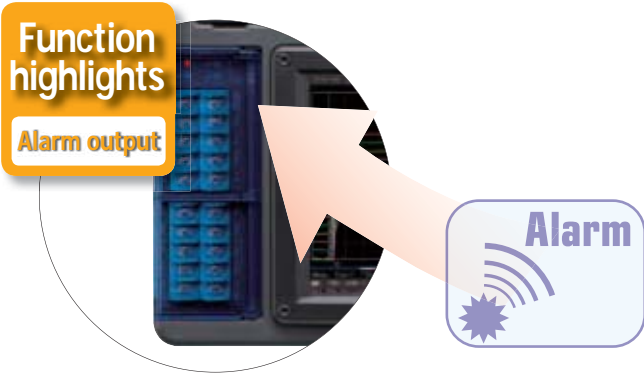

■ Alarm output

The HiLOGGER outputs a signal when alarm criteria are satisfied and also sounds a buzzer. Four systems are provided as standard and separate criteria can be set for each input source enabling OR and AND criteria between channels.

Note: Open-collector output (5 V voltage output and relay drive capacity 5 to 30 V, 200 mA)

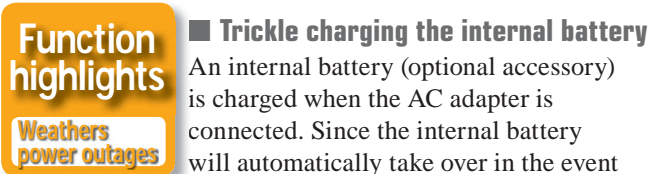

■ Trickle charging the internal battery

An internal battery (optional accessory) is charged when the AC adapter is connected. Since the internal battery will automatically take over in the event of a sudden power outage, it permits uninterrupted operation.

■ Protection of files being stored on external storage media

An internal high-capacity capacitor will provide enough power to store any data at risk on a CF card or USB memory device should a sudden power outage occur during long-term storage. This reduces the risk of data loss and corruption of the file system. Measurements will resume as soon as the power returns.

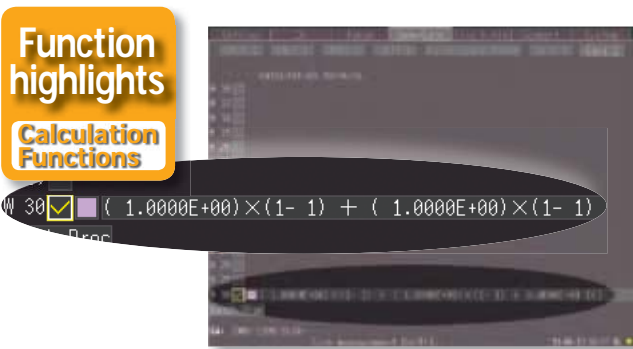

■ Real-time processing functions

The HiLOGGER comes with [four arithmetic operation] functions for processing between channels. Data processed in real-time can be displayed in graph form. In addition, processing results for 30 channels are stored in internal memory and can be handled as data for independent input channels.

■ Records average values every 30 minutes

The HiLOGGER contains a [time-span processing] function. The instrument will save processing data as text data for a preset time period in real-time.



■ Simultaneous recording to storage media and PC

Measurement data can be simultaneously saved to external storage media and a hard disk on a PC connected to a network to reduce the risk data loss.



■ USB and LAN connection for easy setup

The supplied Logger Utility software allows you to set up the logger from a PC. Setup could not be easier. Just follow the numbered procedures to set up the instrument.

Note: Data on an inserted CF card can be copied to a PC via USB connection.

Note: The Logger Utility will enable LAN access with software Ver. 1.20 or later.

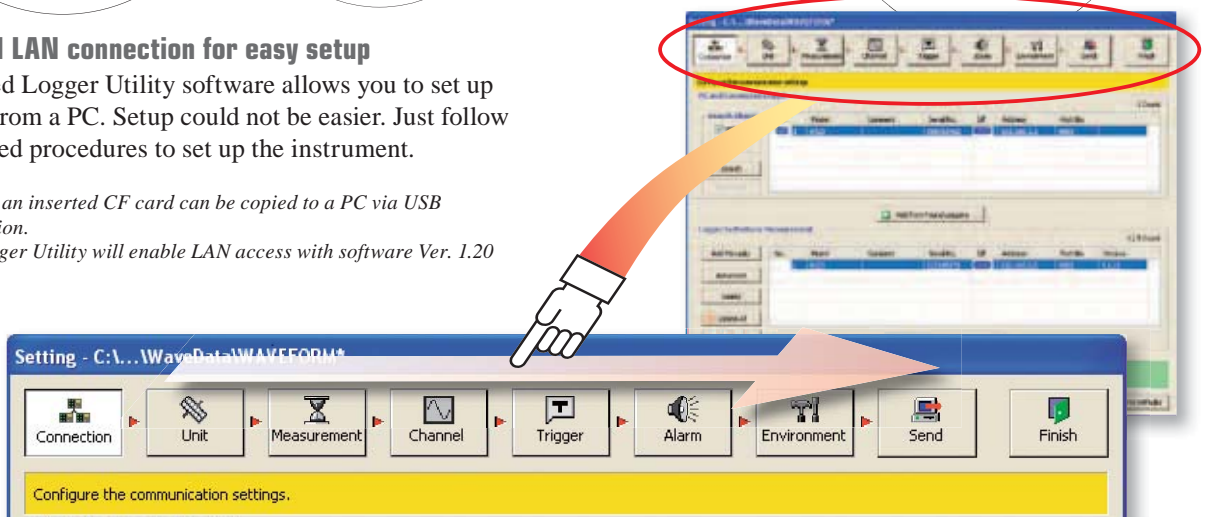

Bundled user-friendly software for PC analysis

Function highlights

PC Measurement

- The supplied Logger Utility software enables processing of measurement data on a PC
- View past data during recording
- Output PC data to a printer



■ Control of measurements from a PC screen

Connect the PC to the HiLOGGER using USB or via LAN* (see note). Use the supplied Logger Utility software to record data on a PC in real-time. Scroll backwards through the displayed trend graph window to view past waveforms even while recording. Up to five HiLOGGERS can be connected to one PC.

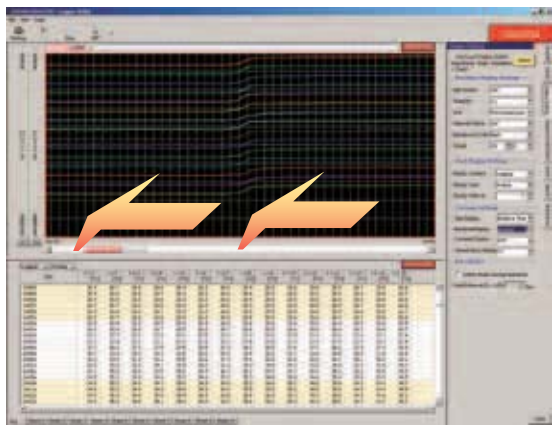

■ Analyze after measuring

Our new “dual-knob function” greatly simplifies data analysis. Two separate waveform windows are provided, with the displayed waveforms showing different time-axis scales (time bases). This capability substantially simplifies long-term data analysis.

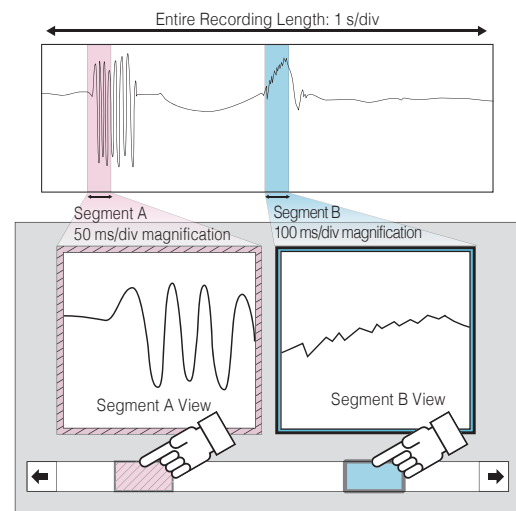

■ Remote control through HTTP server function*

Without the need to install additional software, you can use an ordinary web browser on your PC to set up the HiLOGGER, acquire data and monitor data on the screen.

Note: Waveform data cannot be downloaded from internal memory while measuring.

■ Data acquisition via FTP*

FTP allows the PC to acquire files stored on HiLOGGER storage devices or measurement data in internal memory.

Note: Waveform data cannot be downloaded from internal memory while measuring.

■ Data transfer via FTP*

Data saved in real-time to storage media can be automatically transferred to an FTP server started from the PC either at regular intervals during measurements or when measurements end.

**Note: LAN communication functions support planned from software Ver. 1.20.*

■ Be informed via E-mail*

Your PC or mobile device is notified of storage media full, internal memory full, stop trigger invoked, alarm occurrence and other events via E-mail.

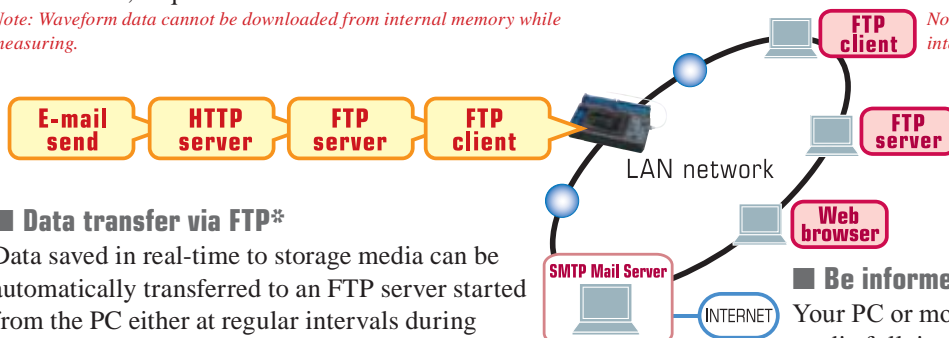

Product Specifications

General specifications (product and accuracy guaranteed for 1 year, post-adjustment accuracy guaranteed for 1 year)	
Internal memory	16 Mega-bytes (8M data points)
Internal clock	Auto calendar, Precision ± 3 s/ day (at 23 °C/ 73 °F)
Accuracy of timebase	± 0.2 s/ day on measurement (at 23 °C/ 73 °F)
Backup battery	For clock and setting conditions: battery life 5 years (at 23 °C/ 73 °F)
Operating temp. & humidity	0 °C (32 °F) to 40 °C (104 °F), 80% rh or less (non-condensating, when charging: 10 °C/ 50 °F to 40 °C/ 104 °F)
Storage temp. & humidity	-10 °C (14 °F) to 60 °C (140 °F), 80% rh or less, (non-condensating)
Conforming standards	Safety : EN61010, EMC : EN61326, EN61000-3-2, EN61000-3-3
Anti-vibration	JIS D1601: 1995 5.3 (I) Corresponds to Class 1: a passenger car, Condition: class A
External control terminal	External trigger input, Trigger output, 4 channel alarm outputs, +12 V/ 100 mA max. output, GND
Dimensions & Mass	Approx. 272 mm (10.71 in) W \times 182.4 mm (7.18 in) H \times 66.5 mm (2.62 in) D, 1.8 kg (63.5 oz), (LR8400 main unit, except the Battery Pack 370 g/ 13.1 oz) Approx. 272 mm (10.71 in) W \times 234.8 mm (9.24 in) H \times 66.5 mm (2.62 in) D, 2.6 kg (91.7 oz), (LR8500 \times 2 and LR8400 \times 1, except the Battery Pack 370 g/ 13.1 oz)
Accessories	Detailed operating manual \times 1, Measurement guide \times 1, AC ADAPTER 9418-15 \times 1, USB cable \times 1, CD-R (data collection software "Logger Utility") \times 1
Data storage media	
CF card	CF card slot \times 1 (Up to 2GB), Data format: FAT, FAT32
USB memory	Series A receptacle
Communication function	
LAN interface (ver. 1.20 or later)	IEEE 802.3 Ethernet 100BASE-TX, DHCP, DNS capable • Data acquisition, condition settings used with the Logger Utility software (supplied as standard) • Use the communication command to set and measure • Data download via FTP server function (stored in the CF card or the USB memory) • Automatically transmit data via FTP client function • Remote control via HTTP server function • Send mail function via E-mail system
USB communication interface	USB 2.0 High-speed capable, series mini-B receptacle • Data acquisition, condition settings used with the Logger Utility software (supplied as standard) • Configure the unit and measure using communication commands • Transfer data from the CF card to a PC via USB drive mode (data transfer not possible from USB memory sticks)
Display section	
Display device	5.7 inch TFT color liquid crystal display (640 \times 480 pixel), horizontal 15 division, vertical 10 division, selectable between English and Japanese displays, Back light saver available
LCD Brightness	Selectable from 100, 70, 40, or 25%
Power supplies	
AC Power	Using the AC ADAPTER 9418-15 (supplied as standard, 100 to 240 VAC, 50/60 Hz), Power consumption: 7 VA (with battery pack removed and maximum brightness)
DC Power	Using the BATTERY PACK Z1000 (optional accessory, 7.2 V, AC adapter has priority when used in combination with battery pack) Continuous operation time: 5 hours (at 23 °C, LCD brightness 25%) Fast recharging time: 3 hours (using the AC adapter and main unit to recharge the battery, at 23 °C, reference value)
External	10 to 28 VDC (Rechargeable voltage 12 to 16 VDC, Please contact your HIOKI distributor for connection cord) Maximum rated power: 24 VA (at 16 VDC external power supply, battery charge, LCD brightness 100%)
Trigger functions	
Trigger mode, timing	Modes : Single / Repeat, Timing : Start / Stop / Start & Stop, Logical sum (OR) and product (AND) of each trigger source, Selectable for each channel
Analog signal source	Configure each individual channel for 30 channels or up to 60 channels depending on number of additional terminal modules installed. [Level trigger] Triggers when rising or falling through preset level [Window] Triggers when entering or exiting range defined by preset upper and lower limit values
Pulse signal source	8 channels of pulse totalizer inputs [Level trigger] Triggers when rising or falling through preset level [Window] Triggers when entering or exiting range defined by preset upper and lower limit values
Digital signal source	8 channels of digital signal inputs [Logic pattern trigger] agreement (or disagreement) in the specified [1/ 0/ \times] pattern
Timer trigger	Set up for year/ month/ day/ hour/ minute/ second
Trigger output	Open collector (active low, with 5 V output, at least 10 ms pulse width), M3 mm screw terminal
Alarm output	
Number of channels	4 channels, non-isolated (common ground with chassis)
Alarm source	60 channels of analog input, 8 channels of pulse totalizer inputs or digital inputs, Thermocouple burn-out detection
Alarm type	Level, Window, Logic pattern, Output latch/ no latch, Cancel alarm while measuring
Alarm sound	Buzzer, ON/OFF possible
Alarm output	Open collector (active low, with 5 V output), M3 mm screw terminal, Output refreshed at every recording interval
Output sink current	200 mA at 5 V to 30 VDC

Measurement Settings			
Recording Intervals (sampling period)	10 ms ^{*1} , 20 ms ^{*2} , 50 ms ^{*3} , 100 ms to 1 hr (19 selections) Note: All input channels are scanned within each recording interval ^{*1} Thermocouple burn-out detection OFF, and using up to 15 channels ^{*2} Thermocouple burn-out detection OFF, and using up to 30 channels, or Thermocouple burn-out detection ON, and using up to 15 channels ^{*3} Thermocouple burn-out detection OFF, and using up to 60 channels, or Thermocouple burn-out detection ON, and using up to 30 channels		
Graph time axis	100 ms/ div to 1 day/ div (21 selections) Note: Setting is independent from the recording interval		
Recording Time	Enable continuous recording ON (records until the Stop key is pressed), or continuous recording OFF (enable a specified time span)		
Repeating Recording	(ON/OFF) Enable to repeat recording after the specified recording time span has elapsed		
Data Saving			
Storage media	Select a CF card or USB memory (Use only PC Cards sold by HIOKI)		
Storage operation	Auto: Save waveform data or time divided calculation results in real time Manual: Push the save key (operation select: item choose/ directly save)		
Real-time saving	Possible: Waveforms are saved approximately one minute as binary or text data to the CF card or the USB memory (if sampling rate is slower than 1 minute, waveforms are saved at each interval) To the PC: Waveforms are saved to the HDD in the PC via LAN or USB communication when used with the Logger Utility Software. Data can be saved in real time to the CF card or USB memory at the same time.		
Divided saving	Simple divide: Save waveform data at pre-set times into separate files from the time measurement starts. On schedule: Designate a reference time within 24 hours and save data into separate files at every set time interval starting from the reference time.		
Delete & save	Endless loop saving: New file overwrites the oldest file when the CF card or USB memory capacity runs short		
Interruptions during saving	Storage media may be removed during real-time save after message confirmation. Upon inserting the storage media again, data saved in internal memory during that time will be saved as a separate file in the media.		
Data protect	Possible: When a power failure occurs during real-time save, the file close sequence is completed before the unit is shut down. When powering with batteries and low battery power is detected, the file close sequence will automatically be executed.		
Saved data types	Setting condition, Waveform data (binary or text style), Calculation of numerical value, Screen data (compressed BMP)		
Loading data	Stored binary data can be recalled by the HiLOGGER in 16 MB quantities		
Calculation function			
Numerical value calculations	No. 1 to 6, maximum 6 calculations can be conducted simultaneously Selections: average value, peak value, maximum value, time at maximum value, minimum value, time at minimum value		
Data range of calculation	All data in internal memory: While measuring/ After measuring Between A/B cursors: After measuring Times: Calculate values at pre-determined 1 sec to 1 day intervals and display the latest value		
Calculation value save	Possible: After measuring the last calculated value is automatically saved to the CF card or USB memory as a text file Timed save: Save calculated data at pre-determined 1 sec to 1 day intervals as text data to the CF card or USB memory in real time.		
Waveform calculations	^{*4} arithmetic calculations between each channel ^{*5} Separate display of calculation graphs (only during measurement) and input waveforms ^{*6} Real-time save of calculation graph data		
Other functions			
Event marking	Search: Move to the event number entered and display the waveforms appearing before and after event Number of events: Maximum 100 per measurement		
A-B cursor	Measurement: time difference between A and B, electric potential difference, electric potential of A or B and time Type: Trace the data, amplitude axis, time axis		
Scaling	Convert and display the measurement value of each channel as a scaled value		
Rate adjustment	Scaling can be set for a channel so that its value is the same as that for UNITI-CHI		
Comment input	Enter a title or a comment for each channel		
Other	Start backup, save ten types setting conditions into main unit, auto set up, start/stop key lock, key-lock, beep sound		
Pulse, Digital input			
Number of channels	8 channels, (digital / pulse selectable for each channel, M3 screw terminal \times 8ch, 2 terminals per channel, not isolated, common ground)		
Input condition	No-voltage 'a' contact (normally open contact), open collector or voltage input, Input resistance: 1.1 M Ω		
Max. allowable input	0 V to 50 VDC (maximum voltage between input terminals that does not cause damage)		
Max. rated voltage between channels	Not isolated (common ground)		
Max. rated voltage to earth	Not isolated (common ground)		
Detect level	2 selectable levels (H: over 1.0 V, L: 0 - 0.5 V), (H: over 4.0 V, L: 0 - 1.5 V)		
Pulse input period	With filter OFF: 200 μ s or more (both H and L periods must be at least 100 μ s) With filter ON: 100 ms or more (both H and L periods must be at least 50 ms)		
Slope	Rising or falling edge can be set for each channel		
Pulse measurement mode	Totalized pulses: Integrated (pulse count integration from start), Instantaneous (pulse count value at each sampling, and integrated value is reset each time) Rotation count: Count input pulses during one second		
Filter	For contact bound resistant (ON/OFF set for each channels)		
Measurement parameters			
	Ranges	Finest Resolution	Range of Measurements
Pulse totalization	1,000 M (pulse) f.s.	1 (pulse)	0 to 1,000 M (pulse)
Pulse rotations	5,000/n (r/s) f.s.	1/n (r/s)	0 to 5,000/n (r/s)
	"n" above is the number of sensor output pulses per rotation, 1 to 1,000		
Digital input	Record logical "1" or "0" at each sampling		

Product Specifications

Analog input section (@23 ±5°C/73 ±9°F, 80% rh or less, after 30 minutes of warm-up and zero-adjustment, with the 50/60 Hz cut-off setting selected)

Voltage Setting Ranges	Resolution	Measurement range	Accuracy
10 mV f.s.	500 nV	-10 mV to 10 mV	±10 μV
20 mV f.s.	1 μV	-20 mV to 20 mV	±20 μV
100 mV f.s.	5 μV	-100 mV to 100 mV	±100 μV
200 mV f.s.	10 μV	-200 mV to 200 mV	±200 μV
1 V f.s.	50 μV	-1 V to 1 V	±1 mV
2 V f.s.	100 μV	-2 V to 2 V	±2 mV
10 V f.s.	500 μV	-10 V to 10 V	±10 mV
20 V f.s.	1 mV	-20 V to 20 V	±20 mV
100 V f.s.	5 mV	-100 V to 100 V	±100 mV
1 – 5 V f.s.	500 μV	1 V to 5 V	±10 mV

Temperature Thermocouples (Compliance standard)
 (Excluding standard reference contact accuracy)
 K, J, E, T, N, R, S, B : JIS C1602-1995, IEC 584
 W : ASTM E-988-96

Thermocouple	Setting Ranges	Resolution	Measurement range	Accuracy
K	100°C f.s.	0.01°C	-100 to less than 0°C	±0.8°C
			0 to 100°C	±0.6°C
	500°C f.s.	0.05°C	-200 to less than -100°C	±1.5°C
			-100 to less than 0°C	±0.8°C
			0 to 500°C	±0.6°C
	2000°C f.s.	0.1°C	-200 to less than -100°C	±1.5°C
J	100°C f.s.	0.01°C	-100 to less than 0°C	±0.8°C
			0 to 100°C	±0.6°C
	500°C f.s.	0.05°C	-200 to less than -100°C	±1.0°C
			-100 to less than 0°C	±0.8°C
			0 to 500°C	±0.6°C
	2000°C f.s.	0.1°C	-200 to less than -100°C	±1.0°C
E	100°C f.s.	0.01°C	-100 to less than 0°C	±0.8°C
			0 to 100°C	±0.6°C
	500°C f.s.	0.05°C	-200 to less than -100°C	±1.0°C
			-100 to less than 0°C	±0.8°C
			0 to 500°C	±0.6°C
	2000°C f.s.	0.1°C	-200 to less than -100°C	±1.0°C
T	100°C f.s.	0.01°C	-100 to less than 0°C	±0.8°C
			0 to 100°C	±0.6°C
	500°C f.s.	0.05°C	-200 to less than -100°C	±1.5°C
			-100 to less than 0°C	±0.8°C
			0 to 400°C	±0.6°C
	2000°C f.s.	0.1°C	-200 to less than -100°C	±1.5°C
N	100°C f.s.	0.01°C	-100 to less than 0°C	±1.2°C
			0 to 100°C	±1.0°C
	500°C f.s.	0.05°C	-200 to less than -100°C	±2.2°C
			-100 to less than 0°C	±1.2°C
			0 to 500°C	±1.0°C
	2000°C f.s.	0.1°C	-200 to less than -100°C	±2.2°C

Thermocouple	Setting Ranges	Resolution	Measurement range	Accuracy
R	100°C f.s.	0.01°C	0 to 100°C	±4.5°C
			0 to less than 100°C	±4.5°C
	500°C f.s.	0.05°C	100 to less than 300°C	±3.0°C
			300 to 500°C	±2.2°C
	2000°C f.s.	0.1°C	0 to less than 100°C	±4.5°C
			100 to less than 300°C	±3.0°C
S	100°C f.s.	0.01°C	0 to 100°C	±4.5°C
			0 to less than 100°C	±4.5°C
	500°C f.s.	0.05°C	100 to less than 300°C	±3.0°C
			300 to 500°C	±2.2°C
	2000°C f.s.	0.1°C	0 to less than 100°C	±4.5°C
			100 to less than 300°C	±3.0°C
B	2000°C f.s.	0.1°C	400 to less than 600°C	±5.5°C
			600 to less than 1000°C	±3.8°C
			1000 to 1800°C	±2.5°C
W	100°C f.s.	0.01°C	0 to 100°C	±1.8°C
	500°C f.s.	0.05°C	0 to 500°C	±1.8°C
	2000°C f.s.	0.1°C	0 to 2000°C	±1.8°C

Other specifications about thermocouple measurement

Reference junction compensation Internal/ External, at INT RJC, total accuracy = ±0.5°C

Thermocouple burn-out detection ON/ OFF, detect at each sampling (when slower than 20 ms)

Temperature Platinum (Compliance standard)
 resistance temperature sensor Pt 100 : JIS C1604-1997, IEC 751, JPt 100 : JIS C1604-1989

Types	Setting Ranges	Resolution	Measurement range	Accuracy
Pt 100	100°C f.s.	0.01°C	-100 to 100°C	±0.6°C
	500°C f.s.	0.05°C	-200 to 500°C	±0.8°C
	2000°C f.s.	0.1°C	-200 to 800°C	±1.0°C
JPt 100	100°C f.s.	0.01°C	-100 to 100°C	±0.6°C
	500°C f.s.	0.05°C	-200 to 500°C	±0.8°C
	2000°C f.s.	0.1°C	-200 to 500°C	±1.0°C

Resistance (testing current 1 mA)	Resolution	Measurement range	Accuracy
10 Ω f.s.	0.5 mΩ	0 to 10 Ω	±10 mΩ
20 Ω f.s.	1 mΩ	0 to 20 Ω	±20 mΩ
100 Ω f.s.	5 mΩ	0 to 100 Ω	±100 mΩ
200 Ω f.s.	10 mΩ	0 to 200 Ω	±200 mΩ

Humidity (use sensor Z2000)	Resolution	Measurement range	Accuracy
100%rh f.s.	0.1%rh	5.0 to 95.0%rh	Refer to table below

Humidity sensor Z2000 accuracy

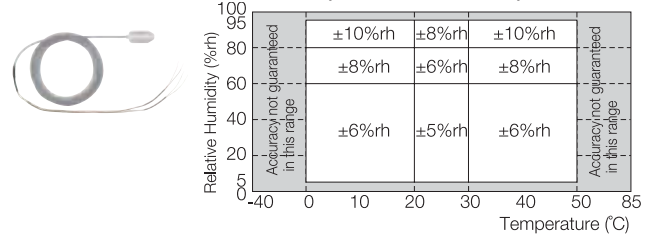

Filter function (Thermocouple/ Resistance temperature sensor/ Voltage/ Resistance/ Humidity)

Digital filter	Select OFF/ 50 Hz/ 60 Hz (In order to remove harmonic components, during analog input the cut-off frequency is automatically set according to the sampling rate)
----------------	--

Optional Product Specifications





VOLTAGE/TEMP UNIT LR8500 (Accuracy guaranteed for 1 year, Post-adjustment accuracy guaranteed for 1 year)

Number of input channels	15 channels (input type selectable from voltage, thermocouple, humidity, for each channel), M3 screw terminals (2 terminals per channel) Note: Isolated from each channel to chassis
Measurement parameters	Voltage, Temperature with thermocouples (K, J, E, T, N, R, S, B, W) Note: Isolated between channels and from each channel to chassis Humidity with the sensor Z2000 Note: Not isolated between channels nor from each channel to chassis
Input conditions	Input resistance: 1 MΩ (at voltage/ thermocouple measurement) Max. rating: ±100 V DC (max. voltage between input terminals without damage)
Max. rated voltage between isolated input channels	250 V DC (max. voltage between input channel terminals)
Max. rated voltage from isolated terminals to ground	300 V AC, DC (max. voltage from terminals to chassis ground without damage)
Measurement accuracy	Refer to MEMORY HiLOGGER main unit specifications
Dimensions & Mass	Approx. 128 mm (5.04 in) W × 52.8 mm (2.08 in) H × 64.5 mm (2.54 in) D, 380 g (13.4 oz)

UNIVERSAL UNIT LR8501 (Accuracy guaranteed for 1 year, Post-adjustment accuracy guaranteed for 1 year)

Number of input channels	15 channels (input type selectable from voltage, thermocouple, Pt 100/ JPt 100, humidity, resistance, for each channel), Push-button type terminals (4 terminals per channel) Note: Isolated from each channel to chassis
Measurement parameters	Voltage, Temperature with thermocouples (K, J, E, T, N, R, S, B, W) Note: Isolated between channels and from each channel to chassis Platinum resistance temperature sensor (Pt 100, JPt 100, 3-wired/ 4-wired, testing current 1 mA) Note: Not isolated between channels Resistance (4-wired, testing current 1 mA) Note: Not isolated between channels Humidity with the sensor Z2000 Note: Not isolated between channels nor from each channel to chassis
Input conditions	Input resistance: 1 MΩ (at voltage/ thermocouple measurement), 2 MΩ (at platinum resistance temperature sensor, or resistance measurement) Max. rating: ±100 V DC (max. voltage between input terminals without damage)
Max. rated voltage between isolated input channels	300 V DC (max. voltage between input channel terminals)
Max. rated voltage from isolated terminals to ground	300 V AC, DC (max. voltage from terminals to chassis ground without damage)
Measurement accuracy	Refer to MEMORY HiLOGGER main unit specifications
Dimensions & Mass	Approx. 128 mm (5.04 in) W × 52.8 mm (2.08 in) H × 64.5 mm (2.54 in) D, 300 g (10.6 oz)

Model Line-up		
Items	Specifications	Model LR8400-20 (built-in the Voltage/temp unit LR8500 x2, 30 ch)
Analog input	Built-in 30 channels <i>Note: Isolated from each channel to chassis</i> [UNIT-1, UNIT-2] M3 screw terminals x 30 channels (2 terminals per channel)	Caution: Built-in M3 screw terminal units cannot be removed or replaced
	Expandable by adding 30 more channels for a total of 60 input channels (optional input unit, Model LR8500 or LR8501, up to 2 units)	
Measurement parameters	Voltage, Temperature with thermocouples (K, J, E, T, N, R, S, B, W) <i>Note: Isolated between channels and from each channel to chassis</i> Humidity with the sensor Z2000 <i>Note: Not isolated between channels nor from each channel to chassis</i>	 <p>M3 screw terminals x 15</p> <p>M3 screw terminals x 15</p>
Input resistance	1 MΩ (at voltage/ thermocouple measurement)	
Max. allowable input	±100 V DC (max. voltage between input terminals without damage)	
Max. rated voltage between isolated input channels	250 V DC (max. voltage between input channel terminals)	
Max. rated voltage from isolated terminals to ground	300 V AC, DC (max. voltage from terminals to chassis ground without damage)	
Items	Specifications	Model LR8401-20 (built-in the Universal unit LR8501 x2, 30 ch)
Analog input	Built-in 30 channels <i>Note: Isolated from each channel to chassis</i> [UNIT-1, UNIT-2] Push-button type terminals x 30 channels (4 terminals per channel)	Caution: Built-in push-button terminal units cannot be removed or replaced
	Expandable by adding 30 more channels for a total of 60 input channels (optional input unit, Model LR8500 or LR8501, up to 2 units)	
Measurement parameters	Voltage, Temperature with thermocouples (K, J, E, T, N, R, S, B, W) <i>Note: Isolated between channels and from each channel to chassis</i> Platinum resistance temperature sensor (Pt 100, JPt 100, 3-wired/ 4-wired, testing current 1 mA) <i>Note: Not isolated between channels</i> Resistance (4-wired, testing current 1 mA) <i>Note: Not isolated between channels</i> Humidity with the sensor Z2000 <i>Note: Not isolated between channels nor from each channel to chassis</i>	 <p>Push-button type terminals x 15</p> <p>Push-button type terminals x 15</p>
Input resistance	1 MΩ (at voltage/ thermocouple measurement) 2 MΩ (at resistance temperature sensor, or resistance measurement)	
Max. allowable input	±100 V DC (max. voltage between input terminals without damage)	
Max. rated voltage between isolated input channels	300 V DC (max. voltage between input channel terminals)	
Max. rated voltage from isolated terminals to ground	300 V AC, DC (max. voltage from terminals to chassis ground without damage)	
Items	Specifications	Model LR8402-20 (built-in the Universal unit x1, Voltage/temp unit x1, 30 ch)
Analog input	Built-in 30 channels <i>Note: Isolated from each channel to chassis</i> [UNIT-1] Push-button type terminals x 15 channels (4 terminals per channel) [UNIT-2] M3 screw terminals x 15 channels (2 terminals per channel)	Caution: Built-in push-button terminal unit and M3 screw terminal unit cannot be removed or replaced
	Expandable by adding 30 more channels for a total of 60 input channels (optional input unit, Model LR8500 or LR8501, up to 2 units)	
Measurement parameters	Voltage, Temperature with thermocouples (K, J, E, T, N, R, S, B, W) <i>Note: Isolated between channels and from each channel to chassis</i> Humidity with the sensor Z2000 <i>Note: Not isolated between channels nor from each channel to chassis</i> [UNIT-1 side only] Platinum resistance temperature sensor (Pt 100, JPt 100, 3-wired/ 4-wired) <i>Note: Not isolated between channels</i> Resistance (4-wired) <i>Note: Not isolated between channels</i>	 <p>Push-button type terminals x 15</p> <p>M3 screw terminals x 15</p>
Input resistance	1 MΩ (at voltage/ thermocouple measurement) 2 MΩ (at platinum resistance temperature sensor, or resistance measurement)	
Max. allowable input	±100 V DC (max. voltage between input terminals without damage)	
Max. rated voltage between isolated input channels	250 V DC at M3 screw terminals, 300 V DC at push-button type terminals (max. voltage between input channel terminals)	
Max. rated voltage from isolated terminals to ground	300 V AC, DC (max. voltage from terminals to chassis ground without damage)	

Software specifications

Logger Utility SF1000 (bundled application software)	
Supported units	Model 8423, 8430, LR8431, LR8432, LR8400, LR8401, LR8402, and LR8410
Operating environment	Windows 10/8/7 (32bit/64bit), Vista (32bit/64bit), XP (with SP2 or later) (32bit)
Real-time data acquisition	Measurements on multiple loggers connected by LAN or USB can be controlled to sequentially acquire, display and save waveform data (for recording up to 10 million samples) Number of controllable instruments: up to 5 units (This software is compatible only with the LR8410-20, LR8400-20series, LR8431-20, 8423, and 8430-20) Display: Waveforms (time-axis divided display possible), numerical values (logging), and alarm status can be displayed at the same time Numerical value display: Can be monitored in a separate window Scroll: Waveform scroll while measuring Data saving destination: Real-time data transfer to Excel, or Real-time data acquisition file (LUW format) Event marks: Can be set while measuring
Data acquisition settings	Data acquisition settings for the logger or logging station Saving: The setting for multiple loggers or logging stations can be saved together in one file (LUS format); Instrument configuration settings can be sent and received
Waveform display	Processed data file: Real-time data acquisition file (LUW format), Record to internal memory data (MEM format) Display format: Simultaneously display waveform and numerical value, (time-axis divided display possible) Maximum number of channels: 675 channels (measurement data) + 60 channels (waveform processing data) Others: Display each channel's waveform on 10 sheets, scroll, record event mark, cursor, screen hard copy, numerical value display



Data conversion	Target data: Real-time data acquisition file (LUW format), record to internal memory data (MEM format) Converted sections: All data, designation section Format: CSV format (separate by comma, space, tab), transfer to Excel spreadsheet, arbitrary data thinning
Waveform processing	Processing items: Four arithmetic operations Number of processing channels: 60 channels
Parameter calculations	Target data: Real-time data acquisition file (LUW format), record to internal memory data (MEM format), data acquired in real time, waveform processing data Calculation items: Average, peak, maximum values, time to maximum values, minimum values, time to minimum values, ON time, OFF time, count the number of ON time and OFF time, standard deviation, integration, area values, totalization
Search functions	Target data: Real-time data acquisition file (LUW format), record to internal memory data (MEM format) Search mode: Event mark, time and date, maximum position, minimum position, maximum pole, minimum pole, alarm position, level, window, amount of change
Print functions	Supported printer: Printer compatible with the OS Target data: Real-time data acquisition file (LUW format), record to internal memory data (MEM format) Print format: Waveform image, report format, list print (channel settings, event, cursor value) Print area: The entire area, area between cursors A and B Print preview: Supported

Main units



Model : MEMORY HiLOGGER LR8400

Model No. (Order Code) (Note)

LR8400-20 (built-in the Voltage/temp unit LR8500 ×2, 30 ch)*Caution: Built-in units cannot be removed or changed. The Battery pack Z1000 is sold separately.*Model LR8400 : Built-in units are equivalent to the Voltage/temp unit LR8500 × 2
Bundled Accessories: Detailed operating manual ×1, Measurement guide ×1, AC ADAPTER 9418-15 ×1, USB cable ×1, CD-R (data collection software "Logger Utility") ×1

Model : MEMORY HiLOGGER LR8401

Model No. (Order Code) (Note)

LR8401-20 (built-in the Universal unit LR8501 ×2, 30 ch)*Caution: Built-in units cannot be removed or changed. The Battery pack Z1000 is sold separately.*Model LR8401 : Built-in units are equivalent to the Universal unit LR8501 × 2
Bundled Accessories: Detailed operating manual ×1, Measurement guide ×1, AC ADAPTER 9418-15 ×1, USB cable ×1, CD-R (data collection software "Logger Utility") ×1

Model : MEMORY HiLOGGER LR8402

Model No. (Order Code) (Note)

LR8402-20 (built-in the Voltage/temp unit ×1, Universal unit ×1, 30 ch)*Caution: Built-in units cannot be removed or changed. The Battery pack Z1000 is sold separately.*

Model LR8402 : Built-in units are equivalent to the Voltage/temp unit LR8500 (15 ch) × 1, and the Universal unit LR8501 (15 ch) × 1

Bundled Accessories: Detailed operating manual ×1, Measurement guide ×1, AC ADAPTER 9418-15 ×1, USB cable ×1, CD-R (data collection software "Logger Utility") ×1

LR8400-20/LR8401-20/LR8402-20 Options in Detail

Input modules

**VOLTAGE/TEMP UNIT LR8500**
2 terminals M-3 mm screw type, 15 channels, Voltage, Temperature with thermocouple, or Humidity measurement, for the LR8400 series**UNIVERSAL UNIT LR8501**
4 terminals push-button type, 15 channels, Voltage, Temperature with thermocouple, Platinum Resistance temperature sensor, Humidity, or Resistance measurement, for the LR8400 series

Input options

**HUMIDITY SENSOR Z2000**
3 m (9.84 ft) length**Thermocouple**
*For reference only. Please purchase locally.

Storage media

**PC Card Precaution***Use only PC Cards sold by HIOKI. Compatibility and performance are not guaranteed for PC cards made by other manufacturers. You may be unable to read from or save data to such cards.*

* Supplied with PC Card adapter

PC CARD 2G 9830
2 GB capacity
PC CARD 1G 9729
1 GB capacity
PC CARD 512M 9728
512 MB capacity

Power supply

**BATTERY PACK Z1000**
NiMH. Charges while installed in the main unit**AC ADAPTER 9418-15**
100 to 240V AC

Carrying cases and stands

**CARRYING CASE C1000**
Includes compartment for options**FIXED STAND Z5000**
For wall hanging and slanted bench mounting

For the PC

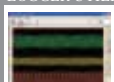
**LOGGER UTILITY SF1000**
The control of the measurement of loggers, real-time data collection**LAN CABLE 9642**
Straight Ethernet cable, supplied with straight to cross conversion adapter, 5 m (16.41 ft) length

High voltage measurement

**DIFFERENTIAL PROBE P9000-01**
(Waveform mode) For up to 1 kV AC, DC**DIFFERENTIAL PROBE P9000-02**
(Waveform / RMS mode selectable) For up to 1 kV AC, DC**AC ADAPTER Z1008**
100 to 240 V AC

Options for Differential Probe

**GRABBER CLIP 9243**
Attaches to the tip of the banana plug cable, 196 mm (7.72 in) length, CAT III 1000 V**CONVERSION CABLE L1011**
30 cm (0.98 ft) length, covert BNC to wire**CONVERSION CABLE L1011-10**
2.4 m (7.87 ft) length, covert BNC to wire

Custom cable

*For the P9000
Inquire with your Hioki distributor.
(1) Bus powered USB cable
(2) USB(A)- Micro B cable
(3) 3-prong cable

Note: Company names and Product names appearing in this catalog are trademarks or registered trademarks of various companies.

HIOKI
HIOKI E. E. CORPORATION

HIOKI

MEMORY HILOGGER LR8431



Featuring USB flash drive support and improved accuracy

Your Personal 10-channel Logger



Real-time recording of up to 10ms/
sample data to USB or CF memory
devices



Small and light enough for the palm
of your hand - yet completely isolated

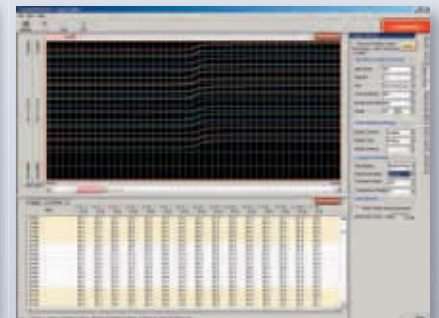

Logger Utility program supports
multi-channel measurements via PC

CE

asita
TECNOLOGIE DI MISURA

Lightest weight in its class and Easy Operation

Featuring USB flash drive support, faster performance, and more accurate thermocouple measurement



Redesigned to be even more capable, Hioki's **10-channel logger still fits in the palm of your hand.**

- ■ **Ultra-compact** for convenient portability
 - Dimensions and mass (HiLOGGER only):
Approx. 176 mm (6.93 in) W × 101 mm (3.98 in) H × 41 mm (1.61 in) D, 550 g (19.4 oz)
- ■ **Provides ten electrically isolated analog input channels** for measuring **voltage and temperature, plus four pulse-counting input channels.**
 - The isolated inputs alleviate constraints while minimizing interchannel interference.
- ■ **10 ms scanning** of all channels provides **rapid sampling capabilities**
 - Track waveforms to meet demands for measuring sudden changes in loads
- ■ **Widescreen, bright LCD** gives excellent **viewability**
 - The beautiful, wide QVGA-TFT display is ideal for waveform monitoring.

Featuring USB flash drive support



The LR8431-20 can record measurement data on a USB flash drive for easy transfer to a computer. In long-term measurement applications, it can also record to reliable Compact Flash cards for increased peace of mind.

1

Replace storage media during real-time recording

Switch out fully loaded storage media with new ones while recording without stopping the measurement so that you can analyze any data recorded so far.

Note: During high-speed recording, be sure to insert the new storage media within 2 minutes of removing the former.

2

Display remaining recording time

The LR8431-20 lets you check the remaining recording time based on the available capacity on your CF card or USB flash drive.

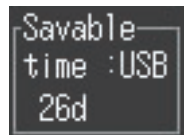

Setting screen

3

Load data from previous MEMORY HiLOGGER 8430-20 models

The LR8431-20 can also load waveform and settings data from previous MEMORY HiLOGGER 8430-20 models, allowing it to make measurements using the same settings and display past data.

4

Copy data between storage media

The LR8431-20 can copy recorded data between the CF card and USB flash drive.

Use only HIOKI CF cards, which are manufactured to strict industrial standards, for long-term storage of important data. Operation of non-HIOKI CF cards is not guaranteed.

The LR8431-20 delivers improved thermocouple measurement accuracy and reference junction compensation accuracy.

Example: When measuring 50°C water with a type-K thermocouple

The LR8431-20 provides improved **accuracy of ±1.5°C**, whereas previous models provided accuracy of ±3°C.

50°C



Improved Accuracy!

Previous
MEMORY HiLOGGER
(8430-20)
±3°C

**LR8431-20
Accuracy
±1.5°C**

Measurement Accuracy: ±2°C
Reference junction compensation accuracy: ±1°C

Measurement Accuracy: ±1°C
Reference junction compensation accuracy: ±0.5°C

Evaluating motors and inverters used in electric and hybrid vehicles

The LR8431-20 enables stable, low-noise measurement of high-speed, high-resistance targets.

Efficiency measurement and performance evaluation of air conditioning equipment

The LR8431-20 supports simultaneous, multi-point measurement, for example of input and output at multiple air conditioning registers or the temperature of internal components.

Temperature measurement and performance evaluation of internal components in electronic equipment

Used with a wind velocity converter, the LR8431-20 can measure cooling efficiency inside equipment enclosures.



This compact logger excels in a broad range of settings, from production lines to research and development.

Key Point

Ten Isolated Analog Input Channels

There's no need to worry about differing potentials of measurement objects when measuring temperature and voltage. All ten analog channels are isolated. Even when measuring temperature and voltage at the same time, interchannel interference and electric shock hazards are eliminated. The four pulse channels are ideal for counting revolution pulses to measure rotation speed. (Pulse inputs share common ground.)

Note: Isolation between channels is possible through the use of semi-conductor relays. Voltage exceeding the product specifications, such as that originating from lightning surges or other sources, should never be applied between each channel; otherwise the relays will short and the recorder will be damaged.

Key Point

High-Speed Sampling

10 ms Sampling and Recording Across All Channels

Abrupt changes in load need to be measured during development of EV • HV • PHV, for which multi-channel, 10 ms sampling is essential. This HiLOGGER can track waveforms that could not be followed with the 100 ms sampling interval previously available.

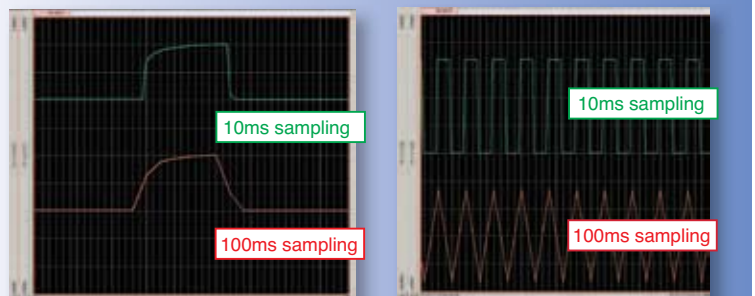

Measurement comparison of abrupt load change in waveform with 10 ms (upper trace) and 100 ms sampling

Measurement comparison of 5 Hz square pulse waveform with 10 ms (upper trace) and 100 ms sampling

(using the supplied Logger Utility program)

Key Point

Enhanced Noise Suppression

Noise-resistant measurement circuitry for improved readings

Measurement involves the deployment of a delta-sigma type A/D converter. Suppress inverter switching noise and line-frequency hum by digital filtering with the HiLOGGER's proprietary oversampling technology.

Note: Optimum noise suppression is obtained for recordings at least two seconds long.

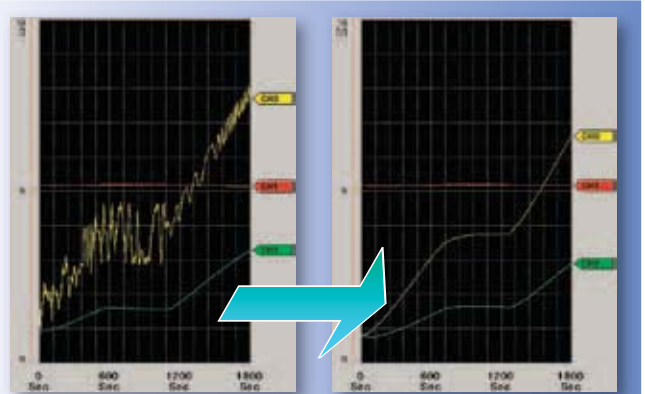

(using the supplied Logger Utility program)

Collect data in real-time with a computer **Logger Utility** (Accessory)

The LR8431-20 ships standard with Logger Utility, a software application that supports multi-channel computer measurement. Simply connect the logger to a computer with a USB cable.

USB connection ensures easy setup

Configure HiLOGGER settings from the Logger Utility. Settings are sequentially ordered and guided from the PC application.

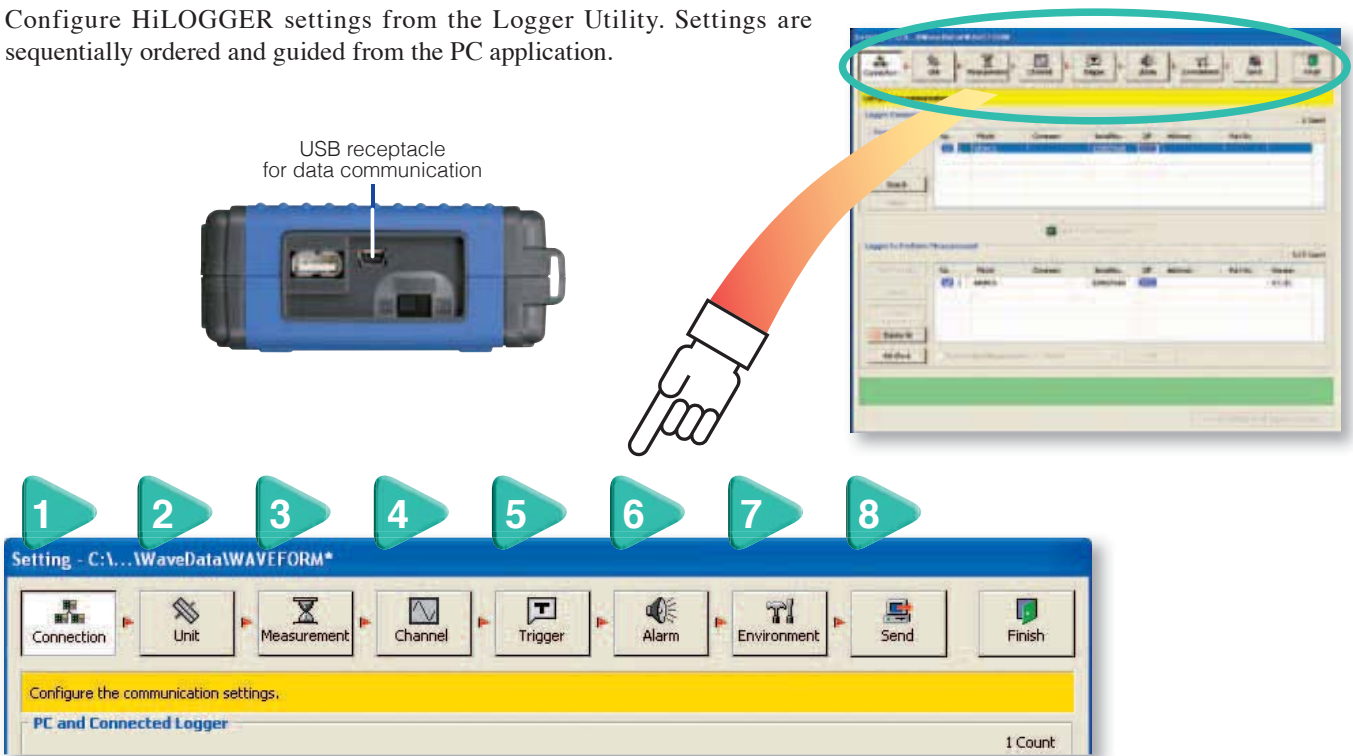

Up to five LR8431-20 instruments can be connected to a single computer with USB cables.

Providing 50 analog and 20 pulse channels that can be graphically displayed together in one window.



■ USB cable connection

A USB hub can be used to enable multi-channel measurement of multiple locations.

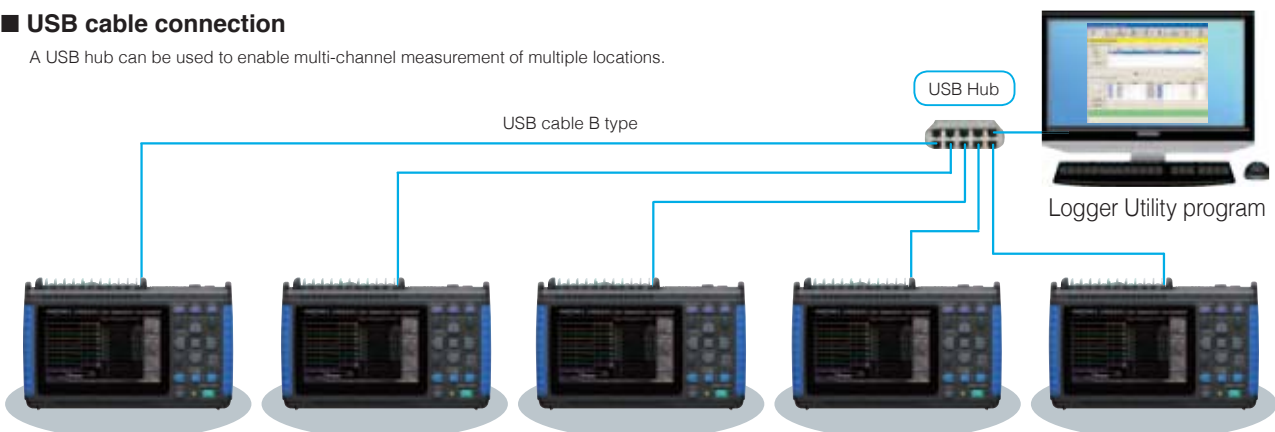

Collect data in real-time with a computer **Logger Utility** (Accessory)

Control measurements from the PC screen

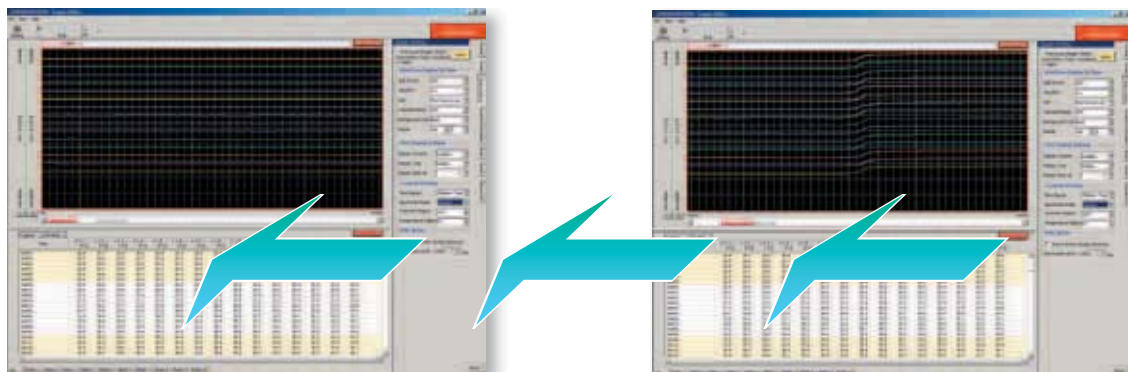

Use the supplied Logger Utility program to control real-time data recording from the PC. Scroll backward through the displayed trend graph window to view past waveforms even while recording.

Up to five LR8431-20 HiLOGGERS can be connected to one PC, providing 50 analog and 20 pulse channels that can be graphically displayed together in one window.

Patented "dual-knob function"

You can use the scrollbar to confirm what the position of the waveform portion displayed on the screen is within the whole recorded waveform. The ability to change the time axis shown on individual windows provides a convenient way to analyze data collected over an extended period of time.

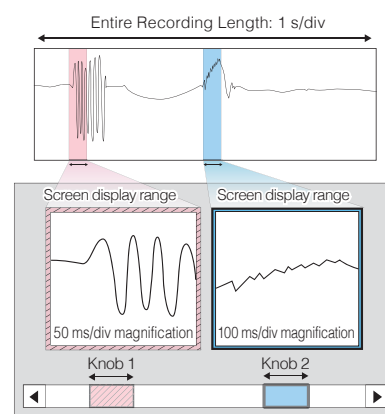

■ Logger Utility (Bundled application software)

Supported units	Model 8423, 8430-20, LR8431-20, LR8432-20, LR8400-20, LR8401-20, LR8402-20, and LR8410-20	Data conversion	Target data: Real-time data acquisition file (LUW format), record to internal memory data (MEM format) Converted sections: All data, designation section Format: CSV format (separate by comma, space, tab), transfer to Excel spreadsheet, arbitrary data thinning
Operating environment	Windows 10/8/7 (32bit/64bit), Vista (32bit/64bit), XP (with SP2 or later) (32bit)	Waveform processing	Processing items: Four arithmetic operations Number of processing channels: 60 channels
Real-time data acquisition	Measurements on multiple loggers connected by LAN or USB can be controlled to sequentially acquire, display and save waveform data (for recording up to 10 million samples) Number of controllable instruments: up to 5 units of any combination Display: Waveforms (time-axis divided display possible), numerical values (logging), and alarm status can be displayed at the same time Numerical value display: Can be monitored in a separate window Scroll: Waveform scroll while measuring Data saving destination: Real-time data transfer to Excel, or Real-time data acquisition file (LUW format) Event marks: Can be set while measuring	Parameter calculations	Target data: Real-time data acquisition file (LUW format), record to internal memory data (MEM format), data acquired in real time, waveform processing data Calculation items: Average, peak, maximum values, time to maximum values, minimum values, time to minimum values, ON time, OFF time, count the number of ON time and OFF time, standard deviation, integration, area values, totalization
Data acquisition settings	Data acquisition settings for the logger or logging station Saving: The setting for multiple loggers or logging stations can be saved together in one file (LUS format); Instrument configuration settings can be sent and received	Search functions	Target data: Real-time data acquisition file (LUW format), record to internal memory data (MEM format) Search mode: Event mark, time and date, maximum position, minimum position, maximum pole, minimum pole, alarm position, level, window, amount of change
Waveform display	Processed data file: Real-time data acquisition file (LUW format), Record to internal memory data (MEM format) Display format: Simultaneously display waveform and numerical value, (time-axis divided display possible) Maximum number of channels: 675 channels (measurement data) + 60 channels (waveform processing data) Others: Display each channel's waveform on 10 sheets, scroll, record event mark, cursor, screen hard copy, numerical value display	Print functions	Supported printer: Printer compatible with the OS Target data: Real-time data acquisition file (LUW format), record to internal memory data (MEM format) Print format: Waveform image, report format, list print (channel settings, event, cursor value) Print area: The entire area, area between cursors A and B Print preview: Supported

Functionality

- ▶ A variety of transducer outputs (DC voltage), or thermocouple measurements over 10 channels
- ▶ 4 Pulse (count) Input Channels, 1 Alarm Output Channel
- ▶ Real-time Save & Long-term recording to CF Card or USB memory

For more reliable data protection, we recommend use of HIOKI CF cards, which are manufactured to strict industrial standards, for real-time saving of data or long-term storage of important data. The USB communications function cannot be used while saving data to a USB flash drive. Operation of non-HIOKI CF cards is not guaranteed.

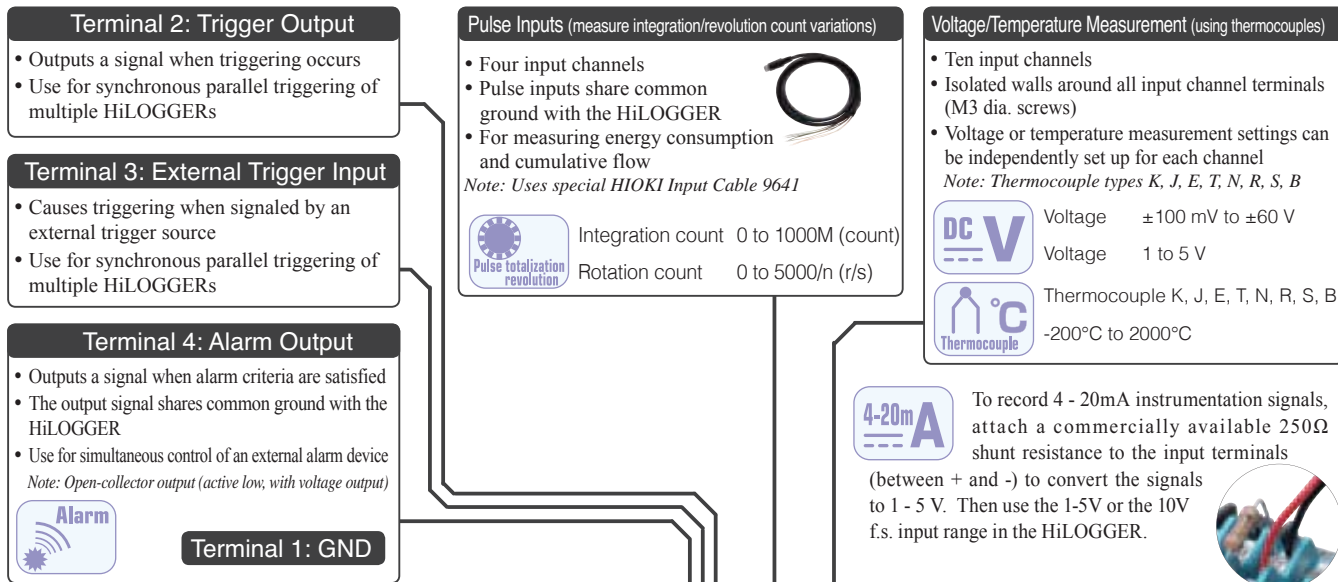

USB Memory (for real-time data saving)



CF Card (for real-time data saving)



Key Point

Real-time Save to CF Card or USB memory

Save every measurement to CF card or USB memory in real time. For more reliable data protection we recommend use of HIOKI CF cards, which are manufactured to strict industrial standards, for long-term storage of important data. (Non-Hioki CF cards are not supported)

Recording Time (Save to External storage in real-time of binary data) *Note: When saving in CSV data format, total recording time is 1/10 or shorter of the following.*

Recording intervals	Recording All Channels (ten analog, four pulse and one alarm)			
	Internal memory (7 MB)	512 MB	1 GB	2 GB
10 ms	32m	1d 15h 14m	3d 06h 29m	6d 12h 58m
20 ms	1h 04m	3d 06h 29m	6d 12h 58m	13d 01h 57m
50 ms	2h 40m	8d 04h 13m	16d 08h 26m	32d 16h 53m
100 ms	5h 21m	16d 08h 26m	32d 16h 53m	65d 09h 47m
200 ms	10h 43m	32d 16h 53m	65d 09h 47m	130d 19h 35m
500 ms	1d 02h 49m	81d 18h 14m	163d 12h 29m	327d 00h 59m
1 s	2d 05h 39m	163d 12h 29m	327d 00h 59m	"★"
2 s	4d 11h 18m	327d 00h 59m	"★"	"★"
5 s	11d 04h 16m	"★"	"★"	"★"
10 s	22d 08h 33m	"★"	"★"	"★"
20 s	44d 17h 06m	"★"	"★"	"★"
30 s	67d 01h 39m	"★"	"★"	"★"
1 min	134d 03h 18m	"★"	"★"	"★"
2 min	268d 06h 36m	"★"	"★"	"★"
5 min to 1 hour	"★"	"★"	"★"	"★"

• Maximum recording time is inversely proportional to number of recording channels.
 • Because the actual capacity of the External storage is less than that indicated, and because the header portion of waveform files is not included in capacity calculations, expect actual maximum times to be about 90% of those in the table.
 • "★" Exceeds 365 days.

Product Specifications (Accuracy guaranteed for 1 year, Post-adjustment accuracy guaranteed for 1 year)

General specifications (product guaranteed for one year)	
Input System/ Channels	Analog inputs: 10 (M3 mm dia. screw terminal block), electrically isolated between channels, and from chassis ground. Input impedance: 1 MΩ (when voltage input or temperature measuring with thermocouple burn-out detection OFF), 800 kΩ (with thermocouple burn-out detection ON) Pulse inputs: 4 channels (requires HIOKI Input Cable 9641) <i>Note: all pulse inputs share common ground with the HiLOGGER</i>
Analog Inputs	Maximum rating: 60 V DC (max. voltage between input terminals without damage) Maximum rated voltage from isolated terminals to ground: 60 V DC (max. voltage between input channel terminals, and from terminals to chassis ground without damage)
Pulse Inputs	Input limits: -5 to +10 V DC (max. voltage between input terminals without damage), non-isolated (common ground between pulse input channels, and with chassis) Pulse signal characteristic: No-voltage relay contact “a”, open collector or voltage input (High: ≥ 2.5 V, Low: ≤ 0.9 V), Period: at least 200 μs (both high and low periods at least 100 μs)
Alarm Output	One channel, non-isolated: output from external control connector (common ground) Signal criteria: configurable high/low threshold levels, enter/exit threshold window, logical sum (OR) and logical product (AND) for every input channel. Output is refreshed each time recording starts. Signal characteristic: Open-collector output (active low, with voltage output) Voltage levels: 4.0 to 5.0 V (H) and 0 to 0.5 V (L), Max. sink current: 5 mA DC, Max. applied voltage: 30 V DC
Internal storage	3.5 MWords (7 MB of two-byte data points, or four-byte pulse measurements)
External storage	CF card: CF card slot × 1 (Up to 2GB), Data format: FAT, FAT32 USB memory: USB 2.0 High-speed capable, series mini-B receptacle, Data format: FAT, FAT32
Backup Function (@25°C)	Backup battery life for clock and settings: approx. 5 years For measurement data: 100 hours with fully charged battery pack, or for as long as AC adapter is connected
External Control Terminals	External Trigger/Event Mark input (exclusion function), Trigger Output, Alarm Output
Display type	4.3-inch WQVGA-TFT color LCD (480 × 272 dots)
Displayable languages	English, Japanese
External Interface	One USB 2.0 series mini B receptacle Functions: Control from a PC (Ver 1.00 or later), Transfers internal data on the CF card to a PC
Environmental conditions (no condensation)	Temperature and humidity range for use: 0°C to 40°C (32°F to 104°F), (or 5°C to 30°C, 41°F to 86°F when battery charging), 80% rh or less Temperature and humidity range for storage: -10°C to 50°C (14°F to 122°F), 80% rh or less
Compliance standard	Safety: EN61010, EMC: EN61326, EN61000
Power Sources	(1) 100 to 240 V AC, 50/60 Hz using AC ADAPTER Z1005 (2) BATTERY PACK 9780 (when used with the AC Adapter, the AC Adapter has priority) (3) 12 V battery (10 to 16 V DC ±10%, Please contact HIOKI for connection cord)
Power Consumption	10 VA
Continuous Operating Time	Approx. 2.5 hours (with Battery Pack Model 9780 while saving to the CF card) Charging time: Approx. 200 minutes (@5°C to 30°C ambient)
Dimensions and mass	Approx. 176 mm (6.93 in) W × 101 mm (3.98 in) H × 41 mm (1.61 in) D, 550 g (19.4 oz) (HiLOGGER only)
Supplied Accessories	Measurement Guide × 1, AC ADAPTER Z1005 × 1, USB cable × 1, CD-R (Instruction Manual, data collection software “Logger Utility”) × 1

Trigger functions

Trigger Source (selectable for each channel)	All analog and pulse channels P1 to P4, external trigger, logical sum (OR) and product (AND) of each trigger source
External Trigger	Criteria: Short-circuit between external trigger input and ground, or voltage input (H-L transition from [3.0 - 5 V] to [0 - 0.8 V]) Pulse width: At least 1 ms (H), and 2 μs (L) Input limits: 0 to 7 V DC
Trigger Timing	Start, Stop and Start/Stop (different trigger criteria can be set to start and stop)
Trigger Types (Analog, Pulse)	Level: Triggers when rising or falling through preset threshold Window: Triggers when entering or exiting range defined by preset upper and lower thresholds
Level Resolution	Analog: 0.025% f.s. (f.s. = 10 display divisions) Pulse: Totalization 1 count, Rotations 1/n [r.s] (n: pulses per rotation)
Pre-trigger	Records for a specified period before triggering; can be set for real-time saving
Trigger Output	(1) Output signal at trigger occurred, (2) Output signal at start or trigger occurred, (1) or (2) mode selectable Open collector (active low, with voltage output, at least 10 ms pulse width, Voltage levels: 4.0 to 5.0 V (H) and 0 to 0.5 V (L), Max. sink current: 5 mA DC, Max. applied voltage: 30 V DC)

Measurement Settings

Recording Intervals (sampling period)	10 ms to 1 hour, 19 selections <i>Note: All input channels are scanned within each recording interval</i>
Graph Timebase Scaling	100 ms to 1 day per division, 21 selections <i>Note: Setting is independent from the recording interval</i>
Repeating Recording	(ON/OFF) Enable to repeat recording after the specified recording time span has elapsed
Recording Time	Enable continuous recording ON (records until the Stop key is pressed), or disable to record for a specified time span (days, hours, minutes and seconds)
Timer Recording	(ON/OFF) Enable to record for a specified time span, or between specified start and stop times
Auto Saving	Waveform (Binary or CSV data): stores data to the CF card or USB memory during real-time measurement Numerical value calculations: stores calculated values to the CF card or USB memory when finishing measuring <i>Note: Don't shutdown while data saving</i>
Data Storage Methods	Each recording can be saved in a separate file Overwriting save (endless loop recording): New data overwrites the oldest data when the storage media is full Divided Saving: Enable to save data at a specified interval (days, hours and minutes) Divided Saving: Specified Time (specify a time of day at which to start saving data to files at a specified interval) <i>Note: Don't shutdown while data saving</i>
Load Stored Data	Stored data can be recalled by the HiLOGGER in 3.5 MWord (7MB) quantities (for a single channel; less for multiple channels)
Settable Save/Reload	Configure saving and reloading to and from CF card or USB memory or internal memory Ten types for internal memory, no limit for CF card and USB memory
Numerical Calculations	Calculations 1 to 4, may be simultaneous Selections: average, peak, maximum and minimum values, time-to-maximum and time-to-minimum
Selectable Filters	50Hz, 60 Hz, or OFF (digital filtering of high frequencies on analog channels)

Channel Settings

Channel Settings	Enable/disable measurement (ON/OFF), selectable waveform color Analog channels (10): Voltage (DC only), Temperature (thermocouple only), Thermocouple types K, J, E, T, N, R, S, B Pulse input channels (4): Count Integration or revolutions Alarm output (1): Hold/not-hold, beeper enable/disable (ON/OFF), Show/hide alarm waveform display (ON/OFF)
------------------	--

Measurement parameters	Ranges	Range of Measurements	Finest Resolution
Voltage	100 mV f.s.	-100 mV to +100 mV	5 μV
	1 V f.s.	-1 V to +1 V	50 μV
	10 V f.s.	-10 V to +10 V	500 μV
	20 V f.s.	-20 V to +20 V	1 mV
	100 V f.s.	-60 V to +60 V	5 mV
1 - 5 V (Note)	1 V to 5 V	500 μV	
Accuracy: ±0.1 % f.s. (Note: 1 - 5V range's f.s. = 10 V)			

Measurement parameters

Measurement parameters	Ranges	Range of Measurements	Finest Resolution
Temperature (Thermocouples)	2000°C f.s.	-200°C to 2000°C	0.1°C
Temperature input ranges (JIS C 1602-1995)	(K) -200°C to 1350°C	(J) -200°C to 1200°C	
	(E) -200°C to 1000°C	(T) -200°C to 400°C	
	(N) -200°C to 1300°C	(R) 0°C to 1700°C	
	(S) 0°C to 1700°C	(B) 400°C to 1800°C	

Measurement Accuracy @23 ±5°C/73 ±9°F, 80% rh or less After 30 minutes warm-up Defined after zero adjustment has been performed	K, J, E, T, ±1.0°C (-100°C or more), ±1.5°C (-200°C to -100°C)
	N: ±1.2°C (-100°C or more), ±2.2°C (-200°C to -100°C)
	R, S: ±2.2°C (300°C or more), ±4.5°C (0°C to 300°C)
	B: ±2.5°C (1000°C or more), ±5.5°C (400°C to 1000°C)
Reference junction compensation [RJC] accuracy: ±0.5°C (horizontal positioning), ±1°C (vertical positioning)	
Internal [RJC] (internal reference junction compensation at 0°C): Measurement accuracy = (temp. measurement accuracy) + (RJC accuracy)	
External [RJC] (using external junction compensation at 0°C): Measurement accuracy = temp. measurement accuracy only	

Temperature Other Functions	Thermocouple burn-out detection: ON or OFF
-----------------------------	--

Measurement parameters	Ranges	Range of Measurements	Finest Resolution
Pulse (Totalization)	1,000 M (count) f.s.	0 to 1,000 M (count)	1 (count)
	Totalization mode: cumulative (counts from start) Instantaneous value: instantaneous value during each recording period		
Pulse (Rotations)	5,000/n (r/s) f.s.	0 to 5,000/n (r/s)	1/n (r/s)
Slope Setting	↑ (count of L-to-H pulse transitions), ↓ (count of H-to-L pulse transitions)		
Displayed Range	Specified by position, or by upper/lower display limit values (Upper/lower limit values only at Totalization mode)		

Common Channel Settings

Scaling	Decimal (display decimal values), Exponential (display base-10 exponents), or Off Method: Ratio (set by slope and intercept), or 2-point (set by input/output values at two points)
Other Common Channel Settings	Enter comments for each channel, set start/stop triggers and alarm criteria

Options in Detail



MEMORY HILOGGER LR8431

Order Code: LR8431-20 (English model)

Supplied Accessories:

Measurement Guide × 1, AC ADAPTER Z1005 × 1, USB cable × 1, CD-R (Instruction Manual, data collection software "Logger Utility") × 1

Supplied Accessories



AC ADAPTER Z1005
100 to 240 V AC

Removable storage (CF card)



Supplied with
PC Card adapter

PC Card Precaution

Use only PC Cards sold by HIOKI. Compatibility and performance are not guaranteed for PC cards made by other manufacturers. You may be unable to read from or save data to such cards.

PC CARD 2G 9830	(2 GB capacity)
PC CARD 1G 9729	(1 GB capacity)
PC CARD 512M 9728	(512 MB capacity)

Battery Pack



Charges while installed
in the HILOGGER

BATTERY PACK 9780
Ni-MH, Charges while installed

Input cables



CONNECTION CABLE 9641
For pulse inputs, 1.5 m (4.92 ft) length

Other



To prevent damage to
the instrument's display

PROTECTION SHEET 9809
For LCD protection, pairs of additional sheets
can be purchased separately.

Case



SOFT CASE 9812
Includes space for small items,
Neoprene rubber



CARRYING CASE 9782
Includes compartment for options,
Resin coated

Related Products



MEMORY HILOGGER LR8400-20

30 isolated analog input channels
With built-in VOLTAGE/TEMP UNIT × 2 modules



MEMORY HILOGGER LR8401-20

30 isolated analog input channels
With built-in UNIVERSAL UNIT × 2 modules



MEMORY HILOGGER LR8402-20

30 isolated analog input channels
With built-in UNIVERSAL UNIT × 1,
VOLTAGE/TEMP UNIT × 1 modules

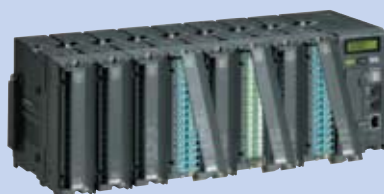

MEMORY HILOGGER 8423

15 to 120 isolated analog channels, with up to
600-channel systems available
LAN/USB support, for measuring with a PC



HEAT FLOW LOGGER LR8432-20

10 isolated analog channels
Use a heat flow sensor to measure the movement and
volume of heat energy
Ultra-compact for convenient portability



WIRELESS LOGGING STATION LR8410-20

15 to 105 isolated analog channels
Logging multi-point data has never been so easy
Install logging modules in hard-to-reach locations

Note: Company names and Product names appearing in this catalog are trademarks or registered trademarks of various companies.

HIOKI
HIOKI E. E. CORPORATION

HIOKI

HEAT FLOW LOGGER LR8432

NEW

Where does the heat go?

A Compact & Lightweight Heat Flow Logger

Ideal for evaluating insulation performance and analyzing the causes of temperature change

Measurement
parameters



* The heat flow sensor shown in the photograph is sold separately.

asita
TECNOLOGIE DI MISURA

Making heat flow visible

What is heat flow?

With temperature fluctuation, there is always a migration of heat.

Heat is energy that causes a change in temperature, and it moves from high to low in the same way as water and electricity.

The degree of this migration is referred to as "heat flow" and is expressed as the amount of heat energy that flows through a given area over a given period of time (units: W/m^2).

Temperature is the result, while heat flow is the process. Temperature fluctuation (heat generation or absorption) cannot be understood solely through temperature measurements using thermocouples and thermography. To get the complete picture, use a heat flow sensor to visualize the movement and volume of heat energy as a leading indicator of temperature fluctuation.

The measurement of heat is useful for achieving more accurate air conditioning control and implementing measures against heat during product development.

Construction and housing equipment

- ✓ Evaluation of ecological houses
- ✓ Evaluation of insulation and thermal barrier performance
- ✓ Evaluation of heating efficiency
- ✓ Evaluation of floor heating systems

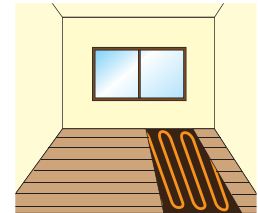

Quantifying heat flow

Quantify heat flow with numerical values and waveforms. Use these numbers to evaluate thermal insulation performance and identify areas where heat flows in and out.

Poor
thermal insulation
performance

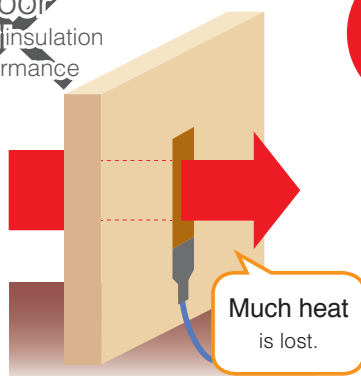

Good
thermal
insulation
performance

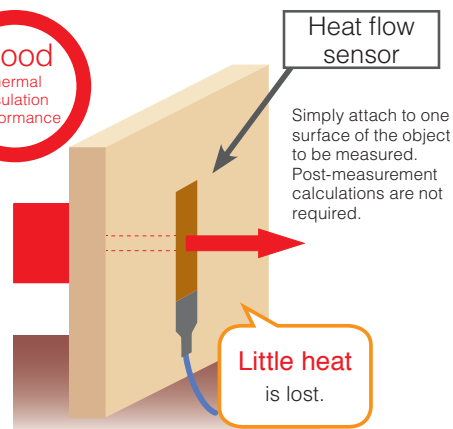

Heat flow
sensor

Simply attach to one surface of the object to be measured. Post-measurement calculations are not required.

Temperature-based
measurement

Measurement is complicated by the need to use thermocouples to measure temperatures on both surfaces and to account for factors such as the thermal resistance of the material.

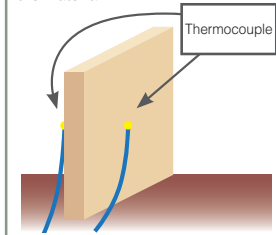

Automobiles

- ✓ Evaluate heat flow from engine rooms and exhaust pipes into a vehicle
- ✓ Evaluate automotive air conditioning
- ✓ Evaluate heat generated and dissipated in automotive parts

Agriculture and civil engineering

- ✓ Evaluation of geo-heat
- ✓ Evaluate the thermal characteristics of greenhouses

Research

- ✓ Manage heat
- ✓ Convert thermoelectricity
- ✓ Heat storage or unused heat (waste heat)

Electrical machinery

- ✓ Evaluate thermal insulation performance of consumer electronics
- ✓ Evaluate cooling and heating systems
- ✓ Evaluate of cooking appliances

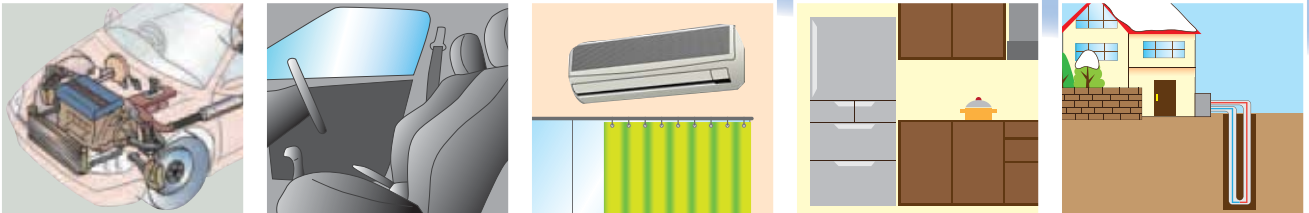

Patterns of flow

Temperature alone cannot reveal the flow of heat (both in and out).
Use heat flow to discover the cause of rises in temperature.

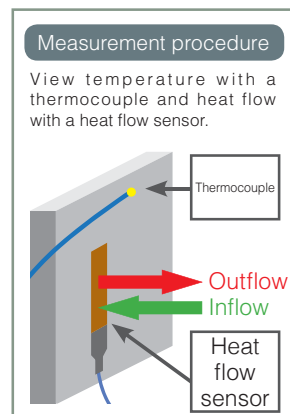
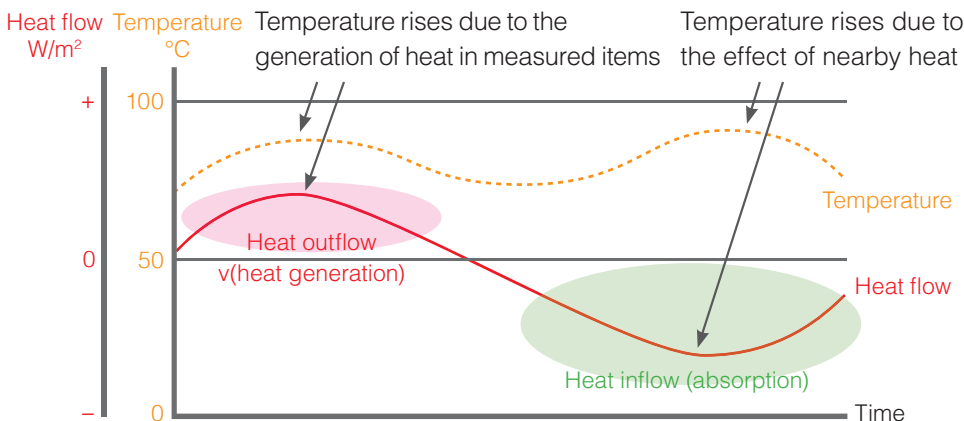

Visualize the underlying causes of temperature change.

Temperatures change due to specific reasons. Heat flow measurement lets you pinpoint those reasons that have been difficult to identify until now.



Isolation of heat generated and dissipated in automotive parts

By identifying why temperature rises, you can design optimal insulation and heat dissipation characteristics.

Conventional approach to measurement (thermocouple only)

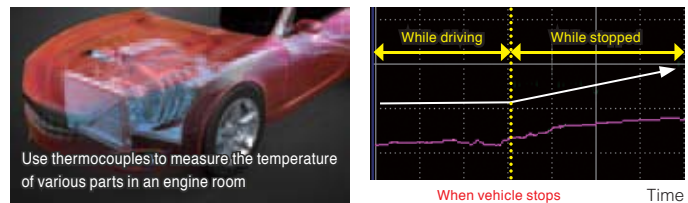

It's clear that the temperature increases but not why, making it difficult to develop thermal countermeasures.

New approach that adds heat flow measurement (thermocouple + heat flow sensor)

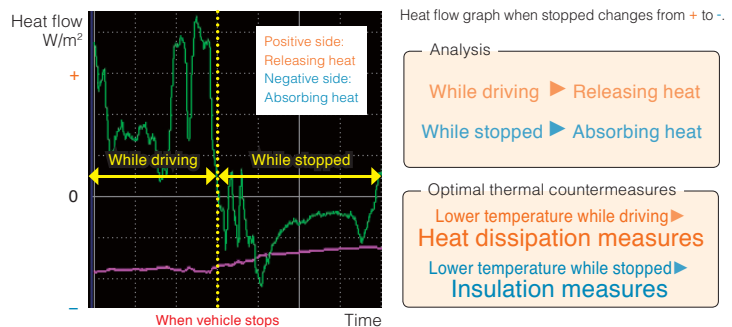

By identifying whether heat is being released or absorbed, you can implement optimal thermal countermeasures.



Evaluate the thermal performance of building materials

The performance of insulating materials can be compared in an effective manner.

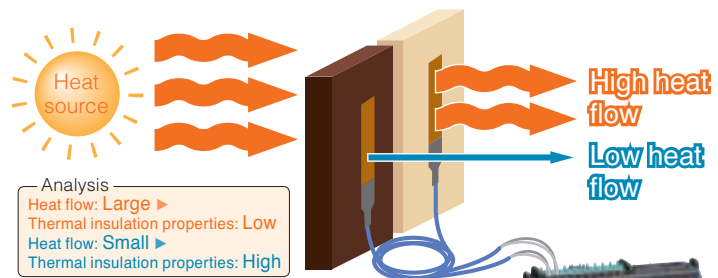

By analyzing the magnitude of heat flows, you can confidently choose building materials with high insulating performance.

Differentiate between optimal thermal insulation material for exteriors, such as roofs and outer walls, and interiors, such as windows and walls.

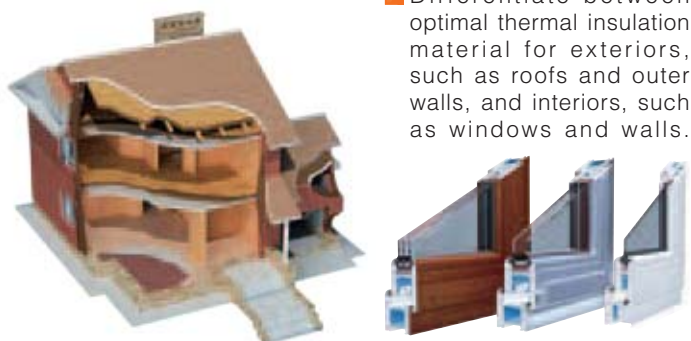

What heat flow measurement makes possible

Measure the energy efficiency of consumer electronics



Measure multiple areas where heat is generated in order to combat heat sources in a variety of consumer electronics.



In addition to large heat-generating parts used in electric appliances such as consumer electronics, you can measure a wide variety of parts down to small electronic boards.

Study the impact of body heat



Measure the flow of heat in human bodies to understand the conduction efficiency of heat in materials and fabrics under development.



Applicable to the development of bathroom floor materials and clothing

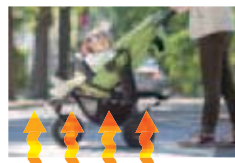

Use radiation sensors and solar radiation meters to measure the effects of heat from the ground and from the sun, which cannot be measured with thermography.

Diagnose the deterioration of insulation material in plant piping



Regularly diagnose the heat flow of thermal insulation material used to understand the deterioration of thermal insulation performance over time.

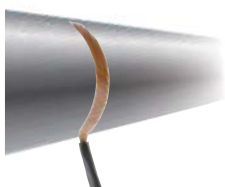

Sensor bends flexibly to measure rounded objects such as piping that could not be measured properly before

Index temperature fluctuation in agriculture and civil engineering



Predict room temperature management in greenhouses affected by external temperature fluctuation.

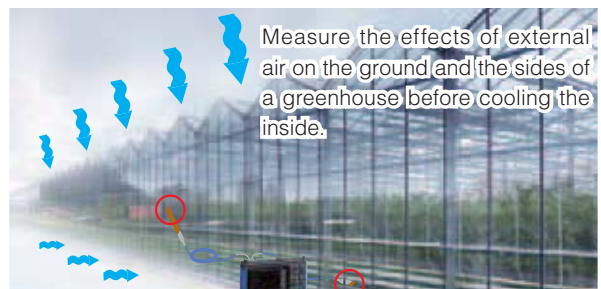

Measure the effects of external air on the ground and the sides of a greenhouse before cooling the inside.



Measure geothermal heat to improve energy efficiency for melting snow through road heating

Familiar operability and a variety of functions for heat flow measurement



Small Most compact & lightweight body in its class

Compact and easy to carry in the palm of your hand
 Dimensions: 176 mm (6.93 in) W x 101 mm (3.98 in) H
 x 41 mm (1.61 in) D
 Mass: 550 g (19.4 oz)

Beautiful Wide QVGA-TFT LCD

Excellent visibility
 Clear display on wide & high-intensity LCD screen

Sensitivity

High sensitivity of 10 mV f.s. for the measurement of minute heat flow



Take accurate and reliable measurements, even in areas with small temperature fluctuations and for the evaluation of high thermal insulation materials

Handling

Save the required information in time-based blocks



● Change USB drive while recording
 In addition, extract data at any point while continuing to take measurements.

Use segmented calculations to determine and save average values and maximum values for each time block (units: minutes).

10 ms

10 ms high-speed sampling on all channels

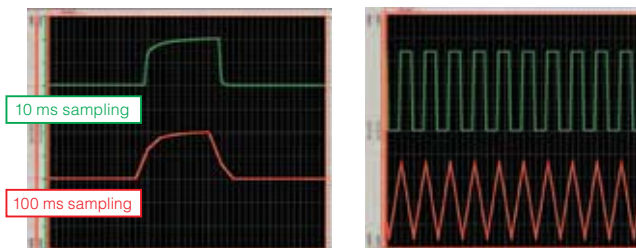

Sampling of waveform with a sudden change in load

Sampling of 5Hz pulse waveform

Measuring sudden changes in load and sampling multiple channels at 10 ms is necessary for the development of electric cars, such as EV, HV, and PHV. Capture waveforms that cannot be sampled with conventional 100ms sampling.

Isolated

10-channel isolated analog input minimizes cross-channel interference

Take reliable temperature and voltage measurements of items with different potentials. There is no risk of interference or electric shock even when also using thermocouples to measure voltage input. Use 4 pulse input channels to integrate rotational pulse and measure rotational speed.



* Semiconductor relays are used for isolation between channels. If voltage that exceeds product specifications, such as a lightning surge, is applied between channels, the semiconductor relays might short circuit. Be sure to take proper precautions to prevent this from occurring.

Noise

Noise-resistant measuring circuitry

Reduce previous trouble caused by switching noise and 50/60 Hz hum noise in inverters

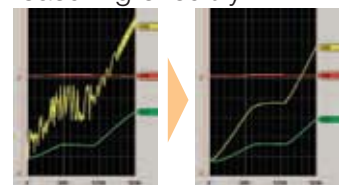

Simple settings for the heat flow sensor

Older systems Since the sensitivity of heat flow sensors varies from sensor to sensor, it was necessary to calculate W/m^2 per 1V from sensor sensitivity to make scaling settings.

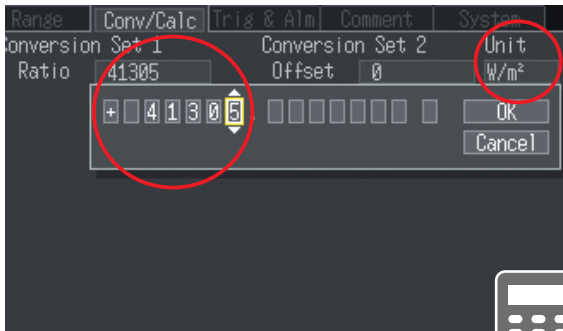

△ Enter the calculated value, and set units manually.

Heat flow logger LR8432-20 Avoid troublesome calculations by directly entering the sensitivity of the heat flow sensor.

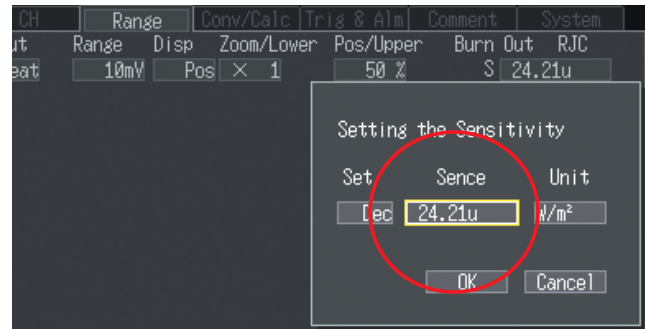

○ Simply enter the sensitivity of the heat flow sensor to complete the settings.

Display heat flow and temperature gauges simultaneously

Older systems Until now it was possible to display only the heat flow sensor gauge or the temperature gauge, switching between them as necessary.

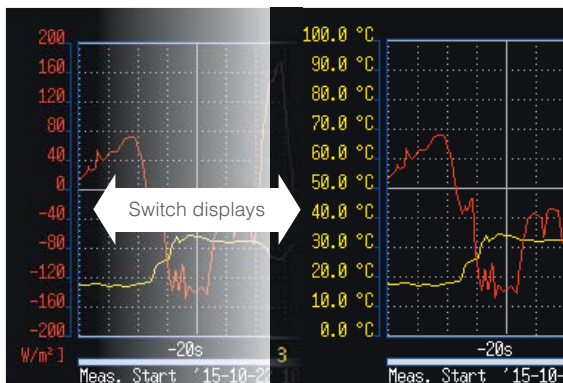

Heat flow (W/m^2)

Temperature ($^{\circ}C$)

Heat flow logger LR8432-20 Display the gauges for data you want to compare at the same time in order to see changes in temperature and heat flow at a single glance.

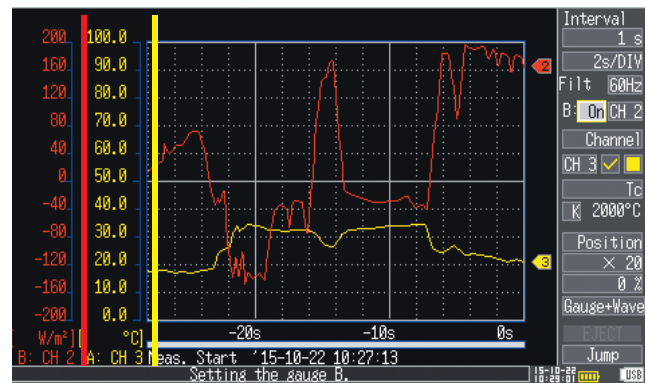

Heat flow (W/m^2)

Temperature ($^{\circ}C$)

Real-time calculation function

Waveform processing

The LR8432-20 has a convenient, built-in waveform processing function for the analysis of temperature and heat flow. Record raw waveforms and post-calculation waveforms at the same time. (Simple average, moving average, integration, heat transmission coefficient)

Real-time calculation of moving average Real-time calculation of integration

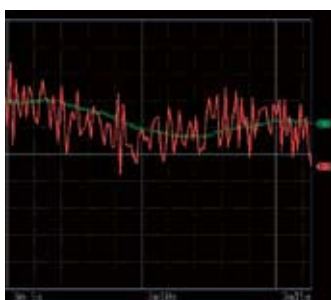

— Moving average waveform
— Raw waveform



Integration at specified intervals

Numerical calculations

Integrate with numerical calculations. Display the sum of energy as a numerical value.

Real-time calculation of sum

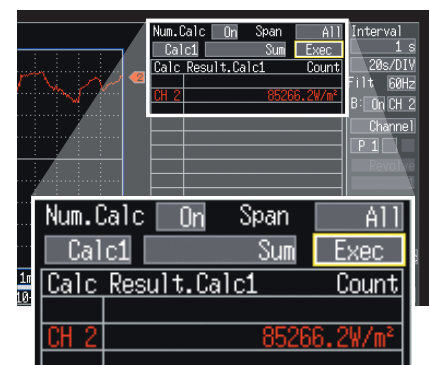

Waterproof heat flow sensor that can measure curved surfaces

Sold separately



Reasonable Cost performance

More affordable than conventional heat flow sensors. Sensitivity has also been improved. (Compared with conventional models.)

SML size Select from 3 sizes

Thickness: 0.28 mm (0.011 in),
Width: 10 mm (0.39 in)
(Photos show actual sizes.)

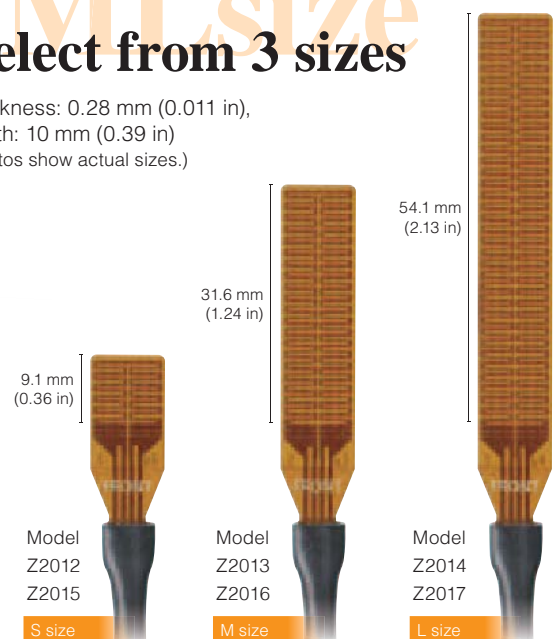

Attachment Procedure Example option: Z5008 thermally conductive double-sided tape

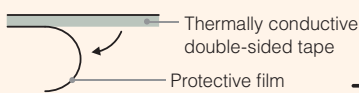

Cut the thermally conductive double-sided tape to the required size, and remove the protective film from one side.

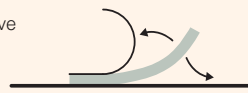

Attach the thermally conductive double-sided tape to the object to be measured, and remove the film from the other side.

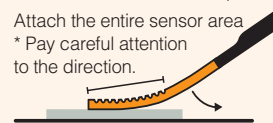

Attach the full length of the back of the sensor (flat surface) to the thermally conductive double-sided tape.

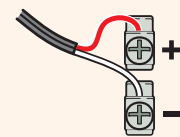

Connect the red wire to the + terminal on the LR8432-20, and the white wire to the - terminal on the LR8432-20.

Note ▶ If heat moves from the rear of the sensor to the front of the sensor at this time, the graph is displayed with a + waveform.

Heat flow sensor (sold separately) Specifications

Model	Z2012 Z2015	Z2013 Z2016	Z2014 Z2017	
Sensor dimensions Approx.)	W	10.0 mm (0.3937 in)		
	L	9.1 mm (0.3583 in)	31.6 mm (1.2441 in)	54.1 mm (2.1299 in)
	T	0.28 mm (0.0110 in)		
Typical sensitivity	0.013 mV/W · m ²	0.049 mV/W · m ²	0.089 mV/W · m ²	
Operating temperature range	Sensor: -40°C to 150°C (-40°F to 302°F), Cords: -40°C to 120°C (-40°F to 248°F)			
Waterproof properties	IP06, IP07 (EN60529)			

Internal resistance (including cord)	3 Ω to 500 Ω	3 Ω to 1000 Ω	3 Ω to 1500 Ω
Minimum radius of curvature	30 mm (1.1811 in)		
Compression stress	4 MPa		
Thermal resistance	1.4 × 10 ⁻³ (m ² ·K/W)		
Repeatable precision	±2%		
Cord lengths (Approx.)	1.5 m (4 ft 11 in) (Z2012, Z2013, Z2014)		
	5 m (16 ft 5 in) (Z2015, Z2016, Z2017)		

Logger Utility for flexible measurement and analysis

Accessory

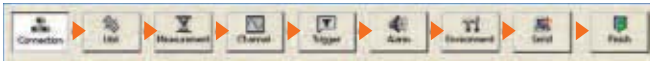

A guide is displayed on the computer screen to make the setting procedure easy to understand.

Easily navigate through logger settings

With this Logger Utility software, you can use a computer to easily make logger settings.

5 units

Simultaneously measure with up to 5 units connected by USB

View graphs for up to 50 analog input channels and up to 20 pulse input channels in a single window at the same time.

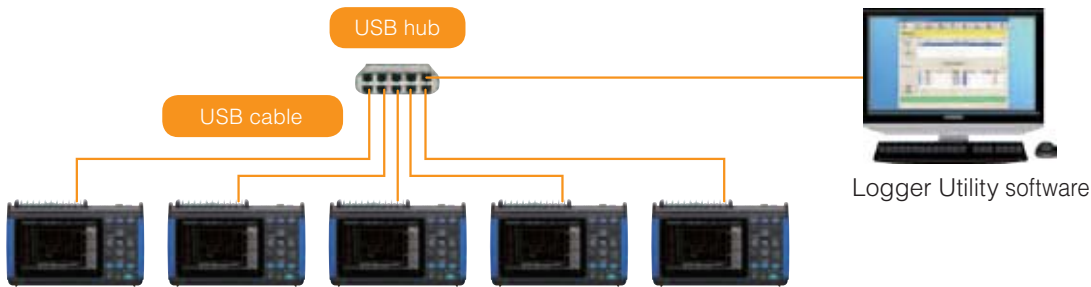

Check

Display past data while measuring

View trend graphs in the window, and scroll back through past waveforms even while recording.

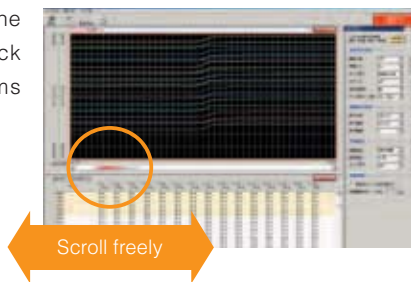

Patented

Double knob functionality for easy analysis

Display independent waveforms in separate windows and use the knobs to change the time axis of each waveform — convenient for long-term data analysis.

* The technology for analysis using the double-knob function is patented by HIOKI.

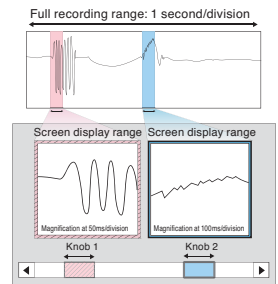

Logger Utility (bundled software) Specifications

Operating system	Windows 8 (32/64bit) / 7 (32/64bit) / Vista (32/64bit) / XP (SP2 or higher) [Supported measuring instruments] LR8432-20, LR8410-20, LR8400-20 series, LR8431-20, 8423, 8430-20	Data conversion	[Supported data] Real-time data collection files (LUW format), logger measurement files (MEM format) [Conversion section] All data, specified sections [Conversion format] CSV format (comma/space/tab delimited), transfer to Excel sheet [Data thinning] Simple thinning based on the desired thinning number
Real-time data collection	Control the measurement of multiple loggers connected via LAN or USB, and receive/display/save waveform data in real-time (up to a total of 10M samples). [Total number of units controlled] 5 (any supported measuring instrument) [Display] Waveform (time axis division), numerical values (logging), and warnings can be displayed at the same time. [Numerical value monitor] Displayed in a separate window. [Scroll] Scroll through waveforms while measuring. [Data save destination] Real-time data transfer to Excel, real-time data collection in files with proprietary format (LUW format). [Event mark] Record while measuring.	Waveform processing	[Calculation items] Four calculations [Number of calculation channels] 60 channels
Data collection settings	[Settings] Make data collection settings for the logger [Save] Save the settings for multiple loggers in a single file (LUS format). [Send/Receive logger settings] Possible	Numerical calculations	[Supported data] Real-time data collection files (LUW format), logger measurement files (MEM format), data during real-time data collection, waveform processing data [Calculation items] Average value, peak value, maximum value, time to maximum value, minimum value, time to minimum value, ON time, OFF time, number of times ON, number of times OFF, standard deviation, integral, area value, integration
Waveform display	[Supported files] Real-time data collection files (LUW format), logger measurement files (MEM format) [Display format] Display waveform (time axis division) and numerical values (logging) at the same time [Maximum number of channels] 675ch (measurement) + 60ch (waveform processing) [Other] Display, scroll, event mark recording, cursor, hard copies of the main screen, and numerical value displays are possible for 10 sheets of waveforms for each channel.	Search	[Supported data] Real-time data collection files (LUW format) Logger measurement files (MEM format) [Search mode] Event mark, date, maximum position, minimum position, ultra-maximum position, ultra-minimum position, warning position, level window, amount of change
		Printing	[Printer support] Printers supported by the operating system [Supported data] Real-time data collection files (LUW format), logger measurement files (MEM format) [Printing format] Waveform image, report printing, list printing (channel settings, event, cursor value) [Printing range] Full range, can specify between A-B cursors [Printing preview] Possible

Functionality

- Heat flow, thermocouple measurements, or a variety of transducer outputs (DC voltage) over 10 channels
- 4 pulse (count) input channels, 1 alarm output channel
- Real-time save & long-term recording to CF card or USB memory

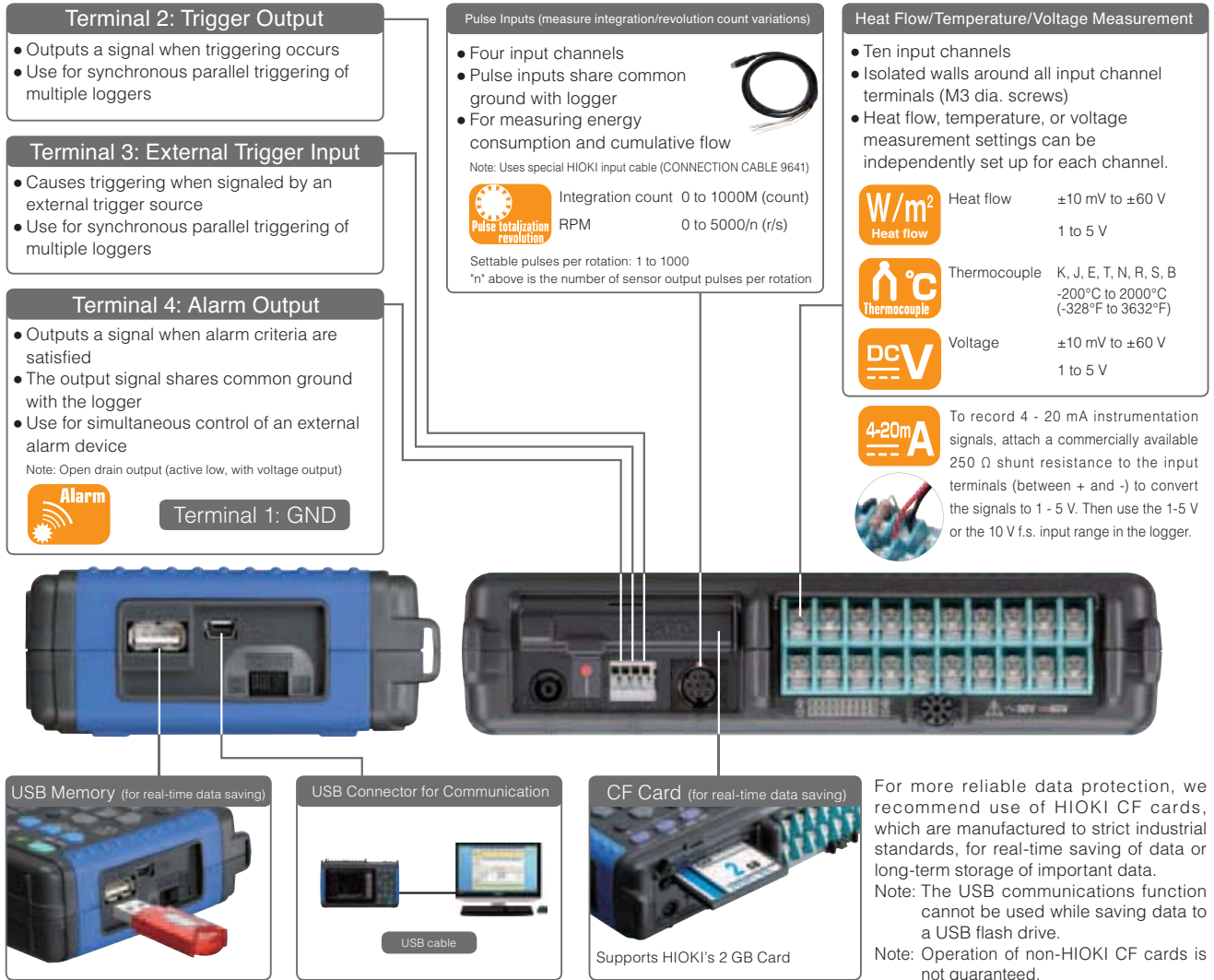

Real-time recording time to storage media (binary format) Note: For CSV format, the recording time is shorter than 1/10 of the values below.

Recording intervals	Recording All Channels (ten analog, four pulse and one alarm) Note: No waveform processing			
	Internal memory (7 MB)	512 MB	1 GB	2 GB
10 ms	32 m	1 d 15 h 14 m	3 d 06 h 29 m	6 d 12 h 58 m
20 ms	1 h 04 m	3 d 06 h 29 m	6 d 12 h 58 m	13 d 01 h 57 m
50 ms	2 h 40 m	8 d 04 h 13 m	16 d 08 h 26 m	32 d 16 h 53 m
100 ms	5 h 21 m	16 d 08 h 26 m	32 d 16 h 53 m	65 d 09 h 47 m
200 ms	10 h 43 m	32 d 16 h 53 m	65 d 09 h 47 m	130 d 19 h 35 m
500 ms	1 d 02 h 49 m	81 d 18 h 14 m	163 d 12 h 29 m	327 d 00 h 59 m
1 s	2 d 05 h 39 m	163 d 12 h 29 m	327 d 00 h 59 m	"H"
2 s	4 d 11 h 18 m	327 d 00 h 59 m	"H"	"H"
5 s	11 d 04 h 16 m	"H"	"H"	"H"
10 s	22 d 08 h 33 m	"H"	"H"	"H"
20 s	44 d 17 h 06 m	"H"	"H"	"H"
30 s	67 d 01 h 39 m	"H"	"H"	"H"
1 m	134 d 03 h 18 m	"H"	"H"	"H"
2 m	268 d 06 h 36 m	"H"	"H"	"H"
5 m to 1 h	"H"	"H"	"H"	"H"

- Maximum recording time is inversely proportional to number of recording channels.
- Because the actual capacity of the external storage media is less than that indicated, and because the header portion of waveform files is not included in capacity calculations, expect actual maximum times to be about 90% of those in the table.
- "H" Exceeds 365 days.

Product Specifications

Basic Specifications (Product guaranteed for 1 year; Accuracy guaranteed for 1 year; Post-adjustment accuracy guaranteed for 1 year)

Input system/channels	Analog inputs: 10, isolated (M3 mm dia. screw terminal block) * Electrically isolated between channels, and from chassis ground. Input impedance: 1 MΩ (when measuring heat flow, voltage, or temperature with a thermocouple and the burn-out detection is OFF), 800 kΩ (with thermocouple burn-out detection ON) Pulse inputs: 4 channels (requires CONNECTION CABLE 9641) Note: all pulse inputs share common ground with logger.
Analog inputs	Maximum rating: 60 V DC (max. voltage between input terminals without damage) Maximum rated voltage from isolated terminals to ground: 30 V AC rms, 60 V DC (max. voltage between input channel terminals, and from terminals to chassis ground without damage)
Pulse inputs	Input limits: 0 to +10 V DC (max. voltage between input terminals without damage). Non-isolated (common ground between pulse input channels, and with chassis) Pulse signal characteristic: No-voltage relay contact a, open collector or voltage input (High: 2.5 V or more, Low: 0.9 V or less), Period: at least 200 μs (both high and low periods at least 100 μs)
Alarm output	One channel, non-isolated: output from external control connector (common ground) Signal criteria: configurable high/low threshold levels, enter/exit threshold window, logical sum (OR) and logical product (AND) for every input channel. Output is refreshed each time recording starts. Signal characteristic: Open drain output (active low, with voltage output) Voltage levels: 4.0 to 5.0 V (H) and 0 to 0.5 V (L), Max. sink current: 5 mA DC, Max. applied voltage: 30 V DC
Internal memory	3.5 MWords (7 MB of two-byte data points, or four-byte pulse measurements)
External memory	CF card: CF card slot × 1 (Up to 2 GB) Data format: FAT, FAT32 USB memory: USB 2.0 High-speed capable, series mini-B receptacle, Data format: FAT, FAT32
Backup function (@25°C)	Backup battery life for clock and settings: approx. 5 years For measurement data: 100 hours with fully charged battery pack, or for as long as AC adapter is connected
Control terminals	External Trigger/Event Mark input (exclusion function), Trigger Output, Alarm Output
Display	4.3-inch WQVGA-TFT color LCD (480 × 272 dots)
Display languages	English, Japanese
External interface	One USB 2.0 series mini B receptacle Functions: Control from a PC (Ver 1.00 or later), Transfers internal data on the CF card to a PC
Environmental conditions (no condensation)	Temperature and humidity range for use: 0°C to 40°C (32°F to 104°F), (or 5°C to 30°C, 41°F to 86°F when battery charging), 80% rh or less Storage: -10°C (14°F) to 50°C (122°F), 80% rh or less
Standard compliance	Safety: EN61010, EMC: EN61326, EN61000
Power supply	AC ADAPTER Z1005: 100 to 240 V AC, 50/60 Hz, 30 VA Max. (including AC adapter), 10 VA Max. (Logger only) BATTERY PACK 9780: 2.5 h continuous operating time (@25°C/77°F), 3 VA Max. External power source: 10 to 16 V DC, 10 VA Max. (Please contact HOKI for connection cord. Max length 3 m/9.84 ft)
Continuous operating time	Approx. 2.5 hours (with Battery Pack Model 9780 while saving to the CF card) Charging time: Approx. 200 minutes (@5°C to 30°C/41°F to 86°F ambient)
Dimensions and mass	Approx. 176 mm (6.93 in) W × 101 mm (3.98 in) H × 41 mm (1.61 in) D, 550 g (19.4 oz) (HEAT FLOW LOGGER only)
Accessories	Measurement Guide × 1, AC ADAPTER Z1005 × 1, USB cable × 1, CD-R (Instruction Manual, data collection software "Logger Utility") × 1

Trigger Functions

Trigger source (selectable for each channel)	All analog and pulse channels P1 to P4, external trigger, logical sum (OR) and product (AND) of each trigger source
External trigger	Criteria: Short-circuit between external trigger input and ground, or voltage input (H-L transition from [3.0 - 5 V] to [0 - 0.8 V]) Pulse width: At least 1 ms (H), and 2 μs (L) Input limits: 0 to 7 V DC
Trigger timing	Start, Stop and Start/Stop (different trigger criteria can be set to start and stop)
Trigger types (Analog, Pulse)	Level: Triggers when rising or falling through preset threshold Window: Triggers when entering or exiting range defined by preset upper and lower thresholds
Level setting resolution	Analog: 0.025% f.s. (f.s. = 10 display divisions) Pulse: Totalization 1 count, Rotations 1/n [r.s] (n: pulses per rotation)
Pre-trigger	Records for a specified period before triggering; can be set for real-time saving
Trigger output	(1) Output signal at trigger occurred, (2) Output signal at start or trigger occurred, Selectable between mode (1) or (2) Open collector (active low, with voltage output, at least 10 ms pulse width, Voltage levels: 4.0 to 5.0 V (H) and 0 to 0.5 V (L), Max. sink current: 5 mA DC, Max. applied voltage: 30 V DC)

Measurement Settings

Recording intervals (sampling period)	10 ms to 1 hour, 19 selections Note: All input channels are scanned at high speed during every recording interval
Graph timebase scaling	100 ms to 1 day per division, 21 selections Note: These settings are different than recording interval.
Repeating recording	(ON/OFF) Enable to repeat recording after the specified recording time span has elapsed
Recording time	Enable continuous recording (continuous recording until the Stop key is pressed), or disable to record for a specified time span (days, hours, minutes and seconds)
Timer recording	(ON/OFF) Enable to record for a specified time span, or between specified start and stop times

Auto saving	Waveform data (binary or CSV): Real-time saving to CF card or USB memory while measuring Numerical calculation results: stores calculated values to the CF card or USB memory when finished measuring Note: Do not power down while data is saving
Real-time saving	Each recording can be saved in a separate file Delete and save: New data overwrites the oldest data when the storage media is full Divided saving: Save data at a specified interval (days, hours and minutes) Divided saving: Specified time (specify a time of day at which to start saving data to files at a specified interval) Note: Do not power down while data is saving
Load stored data	Stored data can be recalled by the logger in 3.5 MWord (7 MB) quantities (for a single channel; less for multiple channels)
Settable save/reload	Configure saving and reloading to and from CF card or USB memory or internal memory Ten types for internal memory, no limit for CF card and USB memory
Numerical calculations	Calculation 1 to Calculation 4, simultaneous calculation possible, Selections: average value, peak value, maximum value, minimum value, time to maximum value, time to minimum value, integration
Calculation range	After stopping: all data in internal buffer memory or between AB cursors While measuring: all data in internal buffer memory Time-delimited calculation: Calculate at the specified times, and display the latest calculated values (only while measuring)
Auto save of calculated results	Possible: Automatically save the final calculated values in text format to CF card or USB memory after measurement. Time-delimited calculation: Save calculation values in real-time at the specified times in text format to CF card or USB memory.
Selectable filters	50 Hz, 60 Hz, or OFF (digital filtering of high frequencies on analog channels)

Channel Settings

Channel settings	Enable/disable measurement (ON/OFF), selectable waveform color Analog channels (10): Voltage, Heat flow, Temperature (thermocouple only), Thermocouple types K, J, E, T, N, R, S, B Pulse input channels (4): Count Integration or revolutions Alarm output (1): Hold/not-hold, beeper enable/disable (ON/OFF), Show/hide alarm waveform display (ON/OFF) Waveform processing 10ch																								
Accuracy guarantee conditions	Warm-up time: 30 minutes or more, after zero-adjustment Cutoff frequency setting: 10 Hz/50 Hz/60 Hz																								
Measurement targets	<table border="1"> <thead> <tr> <th>Range</th> <th>Range of measurements</th> <th>Max. resolution</th> </tr> </thead> <tbody> <tr> <td>10 mV f.s.</td> <td>-10 mV to +10 mV</td> <td>500 nV</td> </tr> <tr> <td>100 mV f.s.</td> <td>-100 mV to +100 mV</td> <td>5 μV</td> </tr> <tr> <td>1 V f.s.</td> <td>-1 V to +1 V</td> <td>50 μV</td> </tr> <tr> <td>10 V f.s.</td> <td>-10 V to +10 V</td> <td>500 μV</td> </tr> <tr> <td>20 V f.s.</td> <td>-20 V to +20 V</td> <td>1 mV</td> </tr> <tr> <td>100 V f.s.</td> <td>-60 V to +60 V</td> <td>5 mV</td> </tr> <tr> <td>1 to 5 V (Note)</td> <td>1 V to 5 V</td> <td>500 μV</td> </tr> </tbody> </table> <p>Accuracy: ±0.1 % f.s. (Note: 1 - 5 V range's f.s. = 10 V)</p>	Range	Range of measurements	Max. resolution	10 mV f.s.	-10 mV to +10 mV	500 nV	100 mV f.s.	-100 mV to +100 mV	5 μV	1 V f.s.	-1 V to +1 V	50 μV	10 V f.s.	-10 V to +10 V	500 μV	20 V f.s.	-20 V to +20 V	1 mV	100 V f.s.	-60 V to +60 V	5 mV	1 to 5 V (Note)	1 V to 5 V	500 μV
Range	Range of measurements	Max. resolution																							
10 mV f.s.	-10 mV to +10 mV	500 nV																							
100 mV f.s.	-100 mV to +100 mV	5 μV																							
1 V f.s.	-1 V to +1 V	50 μV																							
10 V f.s.	-10 V to +10 V	500 μV																							
20 V f.s.	-20 V to +20 V	1 mV																							
100 V f.s.	-60 V to +60 V	5 mV																							
1 to 5 V (Note)	1 V to 5 V	500 μV																							
Measurement targets	<table border="1"> <thead> <tr> <th>Range</th> <th>Range of measurements</th> <th>Max. resolution</th> </tr> </thead> <tbody> <tr> <td>Temperature (Thermocouples)</td> <td>2000°C (3632°F) f.s.</td> <td>-200°C to 2000°C (-328°F to 3632°F)</td> <td>0.1°C (0.18°F)</td> </tr> </tbody> </table>	Range	Range of measurements	Max. resolution	Temperature (Thermocouples)	2000°C (3632°F) f.s.	-200°C to 2000°C (-328°F to 3632°F)	0.1°C (0.18°F)																	
Range	Range of measurements	Max. resolution																							
Temperature (Thermocouples)	2000°C (3632°F) f.s.	-200°C to 2000°C (-328°F to 3632°F)	0.1°C (0.18°F)																						
Temperature input ranges (JIS C 1602-1995)	(K) -200°C to 1350°C (-328°F to 2462°F) (J) -200°C to 1200°C (-328°F to 2192°F) (E) -200°C to 1000°C (-328°F to 1832°F) (T) -200°C to 400°C (-328°F to 752°F) (N) -200°C to 1300°C (-328°F to 2372°F) (R) 0°C to 1700°C (32°F to 3092°F) (S) 0°C to 1700°C (32°F to 3092°F) (B) 400°C to 1800°C (752°F to 3272°F)																								
Measurement accuracy	K, J, E, T: ±1.0°C (1.8°F) (-100°C/-148°F or more), ±1.5°C (2.7°F) (-200°C to -100°C/-328°F to -148°F) N: ±1.2°C (2.16°F) (-100°C/-148°F or more), ±2.2°C (3.96°F) (-200°C to -100°C/-328°F to -148°F) R, S: ±2.2°C (3.96°F) (300°C/572°F or more), ±4.5°C (8.1°F) (0°C to 300°C/32°F to 572°F) B: ±2.5°C (4.5°F) (1000°C/1832°F or more), ±5.5°C (9.9°F) (400°C to 1000°C/752°F to 1832°F) Reference junction compensation [RJC] accuracy: ±0.5°C (0.9°F) (horizontal), ±1°C (1.8°F) (vertical) Internal [RJC] (internal reference junction compensation at 0°C/32°F): Measurement accuracy = (temp. measurement accuracy) + (RJC accuracy) External [RJC] (using external junction compensation at 0°C/32°F): Measurement accuracy = temp. measurement accuracy only																								
Temperature other functions	Thermocouple burn-out detection: ON or OFF																								
Measurement targets	<table border="1"> <thead> <tr> <th>Range</th> <th>Range of measurements</th> <th>Max. resolution</th> </tr> </thead> <tbody> <tr> <td>Pulse (Integration count)</td> <td>1000 M (count) f.s.</td> <td>0 to 1000 M (count)</td> <td>1 (count)</td> </tr> </tbody> </table> <p>Addition: integration value from start, Instantaneous value: instantaneous value during each recording period</p>	Range	Range of measurements	Max. resolution	Pulse (Integration count)	1000 M (count) f.s.	0 to 1000 M (count)	1 (count)																	
Range	Range of measurements	Max. resolution																							
Pulse (Integration count)	1000 M (count) f.s.	0 to 1000 M (count)	1 (count)																						
Pulse (RPM)	5000/n (r/s) f.s.	0 to 5000/n (r/s)	1/n (r/s)																						
Slope setting	Settable pulses per rotation: 1 to 1000 (*n* above is the number of sensor output pulses per rotation)																								
Slope setting	↑ (count of L-to-H pulse transitions), ↓ (count of H-to-L pulse transitions)																								
Display range	Specified by position, or by upper/lower display limit values (Upper/lower limit values only at Totalization mode)																								
Waveform processing	Use the four calculations between channels (+ - × ÷) to display as data for the calculated channels (W1 to W10) (only when measuring). Calculate the data for the set channels using simple averaging, movement averaging, integration, and heat transmission coefficient to display as data for the calculated channels (W1 to W10) (only when measuring).																								
Shared Channel Settings																									
Scaling	Decimal (display decimal values), Exponential (display base-10 exponents), or Off Method: Ratio (set by slope and intercept), or 2-point (set by input/output values at two points) Set the conversion ratio automatically based on the sensitivity of the heat flow sensor (only for measuring heat flow).																								
Other	Enter comments for each channel, set start/stop triggers and alarm criteria																								

Configuration of Various Options



HEAT FLOW LOGGER LR8432

Order Code : LR8432-20 (English model)

Standard accessories

Measurement Guide × 1
 CD-R (Instruction Manual, data collection software "Logger Utility") × 1
 USB cable × 1
 AC ADAPTER Z1005 × 1

Heat flow measurement options

Measurement of small parts and curved surfaces of piping

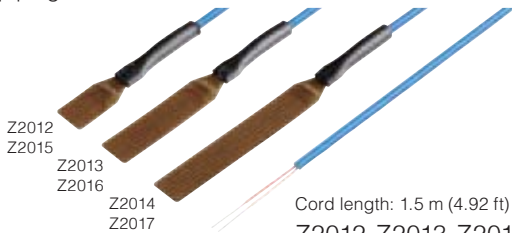

Heat flow sensor
 Waterproof characteristics : IP06, IP07

Cord length: 1.5 m (4.92 ft)
 Z2012, Z2013, Z2014

Cord length: 5 m (16.40 ft)
 Z2015, Z2016, Z2017

Adhesive tape for accurate measurements

20 sheets

Thermally conductive double-sided tape Z5008

Standard accessory



AC ADAPTER Z1005
 100 to 240 V AC, when purchased additionally

CF card

For more reliable data protection we recommend use of HIOKI CF cards, which are manufactured to strict industrial standards, for long-term storage of important data.



PC card adapter included

PC Card Precaution

Use only PC Cards sold by HIOKI. Compatibility and performance are not guaranteed for PC cards made by other manufacturers. You may be unable to read from or save data to such cards.

PC CARD 2G 9830
 PC CARD 1G 9729
 PC CARD 512M 9728

Battery

Can remain mounted on the logger when charging the battery



BATTERY PACK 9780
 NiMH, charges while installed in the main unit

Input



CONNECTION CABLE 9641
 For pulse input; Cable Length: 1.5 m (4.92 ft)

Other

To prevent damage to the logger's display



PROTECTION SHEET 9809
 For LCD protection, pairs of additional sheets

Case



SOFT CASE 9812
 For storing small accessories; Neoprene rubber



CARRYING CASE 9782
 For storing optional accessories; resin exterior

Note: Company names and Product names appearing in this catalog are trademarks or registered trademarks of various companies.

HIOKI
 HIOKI E. E. CORPORATION

HIOKI

MEMORY HiLOGGER 8423

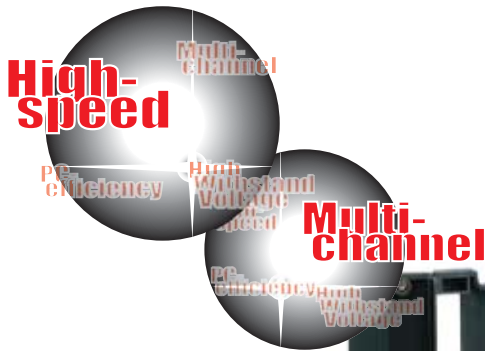

Fast 10-ms Sampling Up to 600 Channels Data Logging

MEMORY HiLOGGER Model 8423 is a data acquisition system capable of measuring and recording multiple channels at high speed. Acquired data can be easily analyzed on a personal computer. This model is ideal for acquiring data for evaluation and testing at development sites. If your evaluation needs require faster data sampling than was available with former HIOKI MEMORY HiLOGGERS, or if you just need more measurement channels, this model has the capabilities you want.

CE

asita
TECNOLOGIE DI MISURA

Who needs 10 ms high-speed sampling?

High-Speed

Multi-channel

PC efficiency

High Withstand Voltage

- Answer -

To acquire data when converting automobile electronics for electric or hybrid vehicles

- Fastest measurement interval (sampling interval) is 10 ms
- Acquires up to 600 channels of data with 10 ms sampling interval
- Insulation withstand voltage between the measurement channels in each module is 200 V (Model 8948)

In the development of electric and hybrid automobiles, the need to capture sudden swings in various loads requires a measurement instrument with multi-channel high-speed sampling capability. For this purpose, HIOKI has developed a very economical logger that can measure with

10-ms sampling interval on all channels. Also included is a dual-sampling function that can measure at two different sampling rates simultaneously. This new model can follow waveforms that former 100-ms-sampling instruments could not.

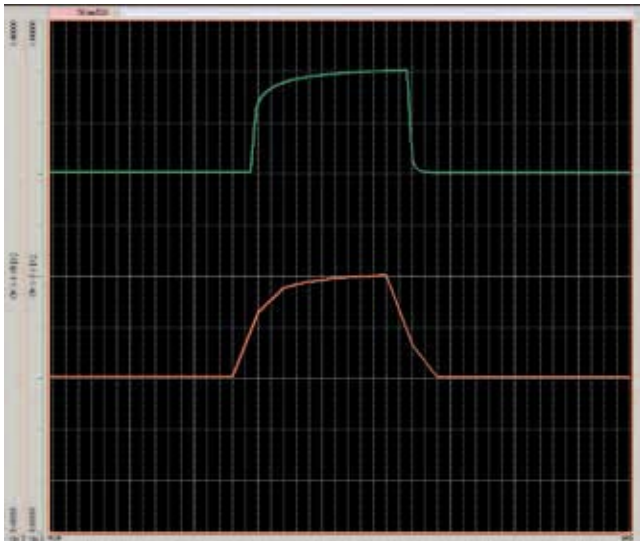

Sudden-load-change testing of a fuel cell employs dual sampling to measure with 10-ms (upper trace) and 100-ms sampling (lower trace). (Timebase: 50 ms/div).

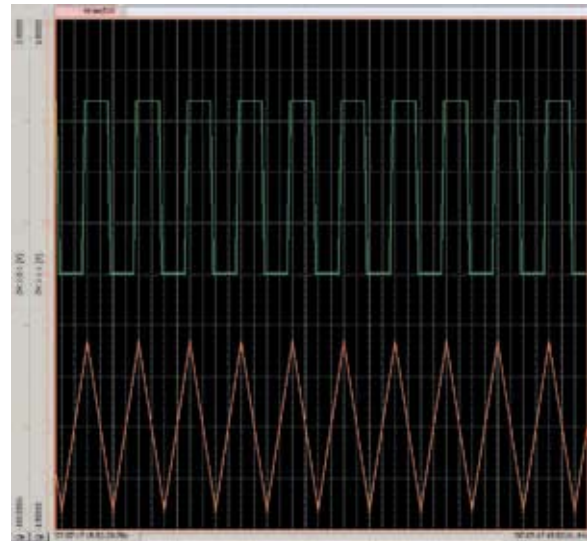

A 5-Hz pulse waveform is measured using dual sampling: 10-ms (upper trace) and 100-ms sampling (lower trace) (Timebase: 50 ms/div).

Who needs 120 or 600 channels?



High-speed
 PE efficiency
 High Withstand Voltage

Multi-channel

- Answer -

To acquire multi-point temperature distribution data
 To measure the voltage of each cell in a stack

- Expandable up to 120 channels with a single instrument
- Up to five instruments can be connected for measuring up to 600 channels
- Isolated to sustain up to 600 V between modules and earth

Temperature distribution is measured to evaluate air conditioning systems during development. A system to acquire data on up to 600 channels can be constructed with merely a LAN or USB connection, providing highly detailed temperature distribution measurements.

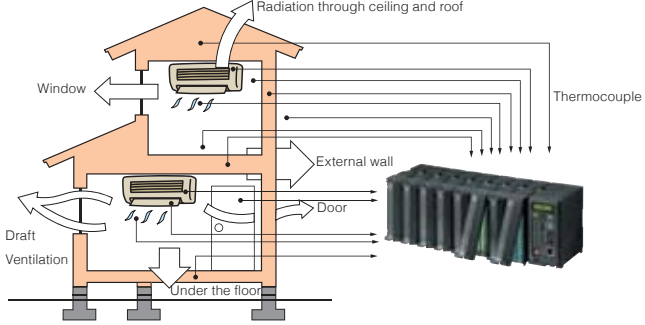

To evaluate heat radiation characteristics and copy machine operation, temperatures at many points inside the chassis and analog voltages from the control board are simultaneously measured.

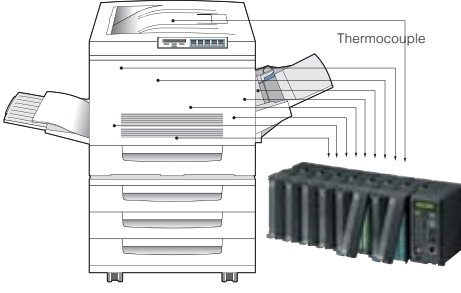

With all channels isolated and a 600V AC/DC maximum rated voltage to earth, even when the common mode voltage increases as is common with layered batteries, the voltage of each individual battery cell can be safely measured.

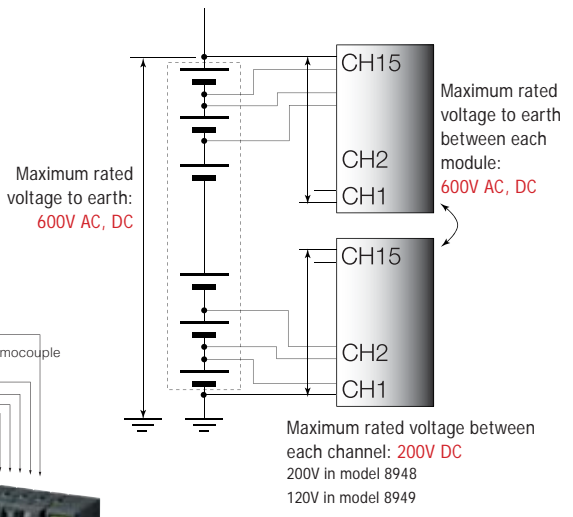

“Simplicity” as a Design Concept



Installation

Because the terminal blocks are designed to be removable, thermocouples can be connected to the terminal block in hand before connecting the block to a HiLOGGER input module, with just one touch.



Easily add input modules: just align and mate the connectors on the left side of the instrument assembly, and turn the metal clasp. For added strength, attach the supplied mounting bracket on the rear, or attach a standard DIN rail to the rear for tray or rack mounting.

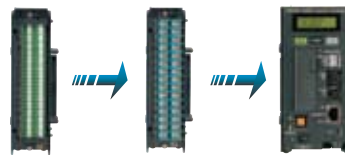

Each measurement module daisy-chains onto the stacking configuration.



Mounting with a standard DIN rail is supported.



Measurement configuration settings

Logger configuration settings are made from a computer running the supplied application program. Settings can be easily made using familiar PC operations. To keep the process simple, the user is guided sequentially through the setting items.

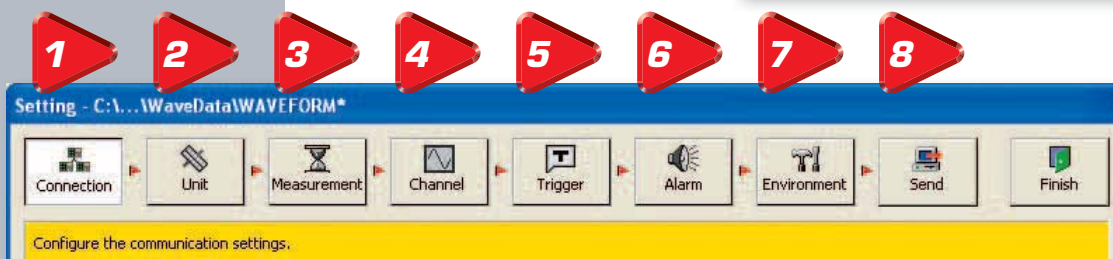
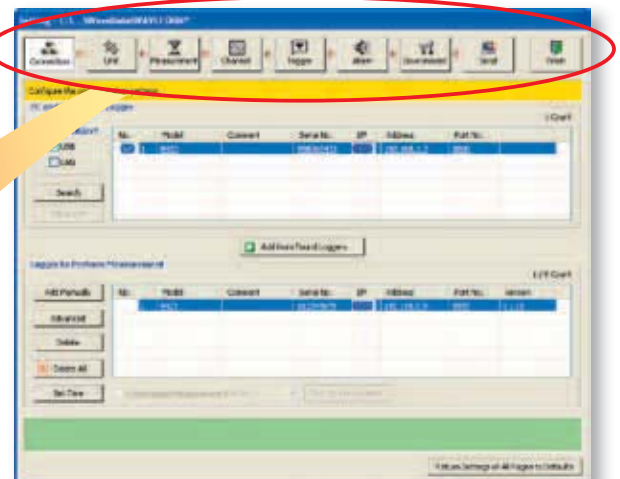



View your data even while measuring!

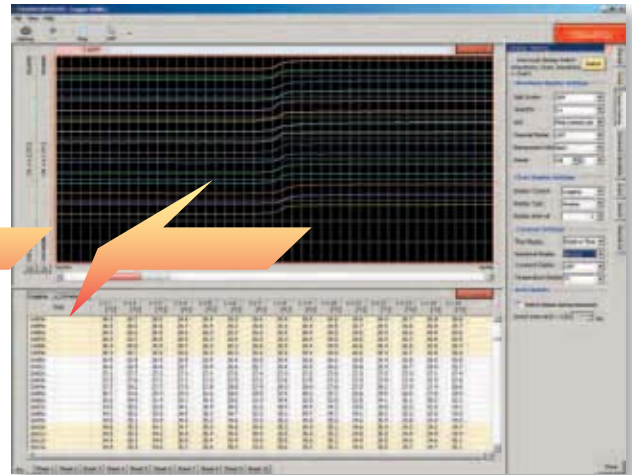
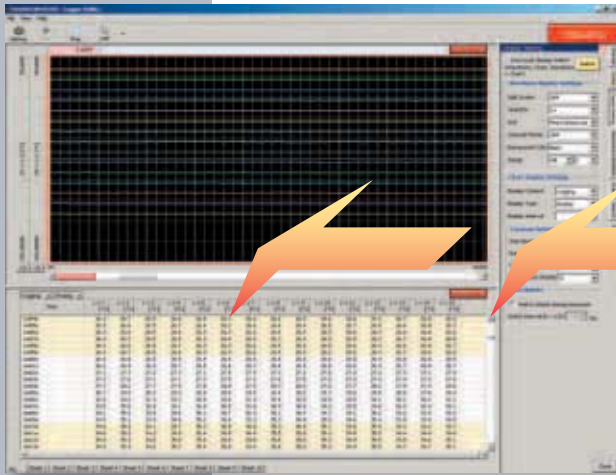

Direct connection with a LAN crossover or USB cable



Data is recorded on the computer in real time using the supplied Logger Utility PC application program. View a trend graph in a window and scroll back to view earlier waveform data, even while recording.



Post-measurement analysis (New Double-Thumb function*)

The newly developed Double-Thumb function simplifies analysis. Two windows are displayed side by side, each with a scroll bar at the bottom containing a thumb (scroll box) that corresponds to the length and position of that window's displayed segment within the overall waveform. The thumbs in the scroll bars of the waveform display windows show you the position of the segments at a glance, greatly simplifying scrolling operations.

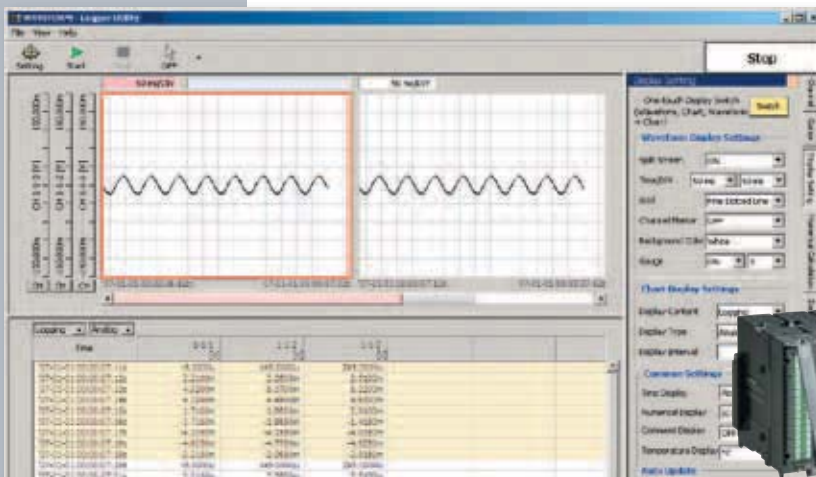
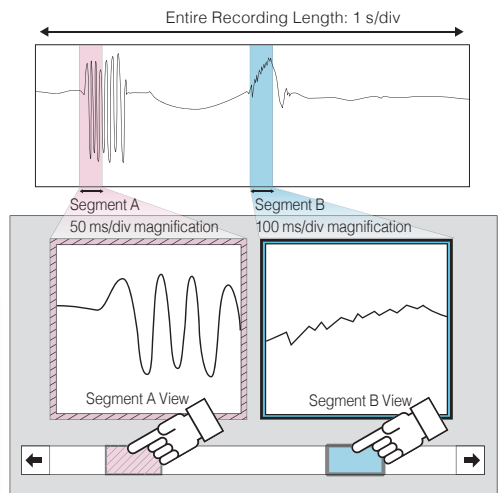

More Functional Details

Universal isolated inputs for temperature, voltage and pulses

*1 Pt (platinum resistance temperature sensor) and humidity measurements require UNIVERSAL UNIT 8949
*2 Requires optional HUMIDITY SENSOR 9701

With the modular input design, you can select the input modules appropriate for your measurement application. Select from voltage and temperature (thermocouple or Pt input*) and humidity.*¹ *² Also, Digital Pulse Module 8996 provides 15 input channels for totalization/rotation counts and Hi/Lo logic measurements. In addition to inter-channel input isolation, the PC connection interface is completely isolated from the measurement terminals, minimizing shock hazards and interference even when measuring thermocouple and voltage inputs at the same time.

Note: Isolation between channels is possible through the use of semi-conductor relays. Voltage exceeding the product specifications, such as that originating from lightning surges or other sources, should never be applied between each channel; otherwise the relays will short and the recorder will be damaged.

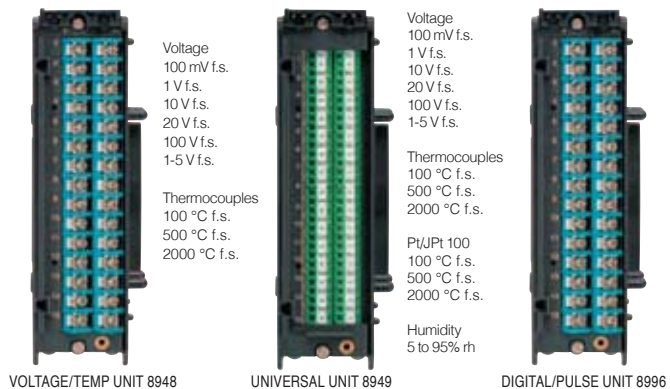

Real-time saving to CF Card

Each measurement can be saved to a CF Card in real time. Continuous long-term recording can be performed with high capacity CF Cards up to 1 GB. Data can be viewed on a PC using the supplied Logger Utility program.

Enhanced data protection from power failures

This exclusive technology has been developed to preserve data as reliably as possible in the event of a power failure, by incorporating memory card technology with the know-how built into the MEMORY HILOGGER 8420-50, 8421-50 and 8422-50 series. The 8423 emphasizes the existing HiLOGGER functions and maintains internal supply voltage with a large internal capacitor until all data has been saved to the card, resulting in greater reliability when acquiring large amounts of data.



A CF Card slot is included as a standard feature, supporting HIOKI CF Cards up to 1 GB (operation with non-HIOKI-brand cards is not guaranteed). Using a CF Card, instrument settings can be easily copied from one 8423 to another.

Recording Times with a 512 MB Card (Voltage, Temperature and Humidity Measurements, but no Pulse Channels)

Recording intervals	512MB (using 1 channel)	512MB (using 15 channels)	512MB (using 30 channels)	512MB (using 60 channels)	512MB (using 120 channels)
10ms	31 d 01 h 39 min	2 d 01 h 42 min	1 d 00 h 51 min	12 h 25 min	6 h 12 min
20ms	62 d 03 h 18 min	4 d 03 h 25 min	2 d 01 h 42 min	1 d 00 h 51 min	12 h 25 min
50ms	155 d 08 h 16 min	10 d 08 h 33 min	5 d 04 h 16 min	2 d 14 h 08 min	1 d 07 h 04 min
100ms	310 d 16 h 32 min	20 d 17 h 06 min	10 d 08 h 33 min	5 d 04 h 16 min	2 d 14 h 08 min
200ms	"★"	41 d 10 h 12 min	20 d 17 h 06 min	10 d 08 h 33 min	5 d 04 h 16 min
500ms	"★"	103 d 13 h 30 min	51 d 18 h 45 min	25 d 21 h 22 min	12 d 22 h 41 min
1s	"★"	207 d 03 h 01 min	103 d 13 h 30 min	51 d 18 h 45 min	25 d 21 h 22 min
10s	"★"	"★"	"★"	"★"	258 d 21 h 47 min
1min	"★"	"★"	"★"	"★"	"★"
10min	"★"	"★"	"★"	"★"	"★"
1hour	"★"	"★"	"★"	"★"	"★"

Note: Actual CF data capacity is less than total CF storage capacity, and waveform file headers are not included in these calculated values, so we recommend using 90% of these values for estimation purposes.

Note: "★" Periods longer than 1 year is abbreviated.

Recording Times with a 512 MB Card (Pulse Channels use only)

Recording intervals	512MB (using 1 channel)	512MB (using 15 channels)	512MB (using 30 channels)	512MB (using 60 channels)	512MB (using 120 channels)
10ms	15 d 12 h 49 min	1 d 00 h 51 min	12 h 25 min	6 h 12 min	3 h 06 min
20ms	31 d 01 h 39 min	2 d 01 h 42 min	1 d 00 h 51 min	12 h 25 min	6 h 12 min
50ms	77 d 16 h 08 min	5 d 04 h 16 min	2 d 14 h 08 min	1 d 07 h 04 min	15 h 32 min
100ms	155 d 08 h 16 min	10 d 08 h 33 min	5 d 04 h 16 min	2 d 14 h 08 min	1 d 07 h 04 min
200ms	310 d 16 h 32 min	20 d 17 h 06 min	10 d 08 h 33 min	5 d 04 h 16 min	2 d 14 h 08 min
500ms	"★"	51 d 18 h 45 min	25 d 21 h 22 min	12 d 22 h 41 min	6 d 11 h 20 min
1s	"★"	103 d 13 h 30 min	51 d 18 h 45 min	25 d 21 h 22 min	12 d 22 h 41 min
10s	"★"	"★"	"★"	258 d 21 h 47 min	129 d 10 h 53 min
1min	"★"	"★"	"★"	"★"	"★"
10min	"★"	"★"	"★"	"★"	"★"
1hour	"★"	"★"	"★"	"★"	"★"

Note: Actual CF data capacity is less than total CF storage capacity, and waveform file headers are not included in these calculated values, so we recommend using 90% of these values for estimation purposes.

Note: "★" Periods longer than 1 year is abbreviated.

Trigger function

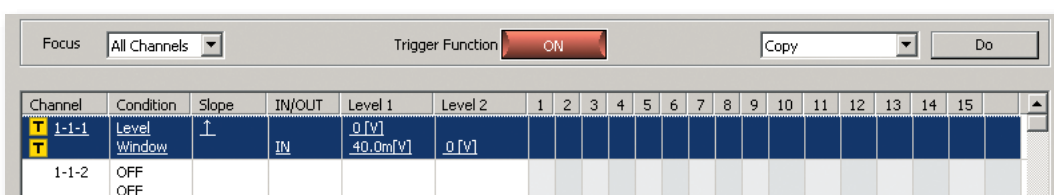

Level, Window and Logic trigger functions are provided. You can have one criterion start recording and another stop recording.

Dual Sampling

Two different measurement intervals can be specified at the same time (one interval setting per input module). Using dual sampling, the appropriate measurement interval can be set for each type of object to be measured, optimizing use of internal memory and CF Card capacity.

Time	1-1-2 [V]	1-1-3 [V]	1-2-1 [°C]
'07-05-23 14:34:22.2s	0.7370	0.9864	26.10
'07-05-23 14:34:22.3s	0.6488	0.8735	-----
'07-05-23 14:34:22.4s	0.4979	0.6766	-----
'07-05-23 14:34:22.5s	0.2983	0.4132	-----
'07-05-23 14:34:22.6s	0.0698	0.1098	-----
'07-05-23 14:34:22.7s	-0.1642	-0.2024	-----
'07-05-23 14:34:22.8s	-0.3824	-0.4953	-----
'07-05-23 14:34:22.9s	-0.5618	-0.7379	-----
'07-05-23 14:34:23.0s	-0.6848	-0.9065	-----
'07-05-23 14:34:23.1s	-0.7414	-0.9868	-----
'07-05-23 14:34:23.2s	-0.7252	-0.9705	26.07
'07-05-23 14:34:23.3s	0.6360	0.8392	-----

Fast sampling
100 m seconds

Slow sampling
1 second

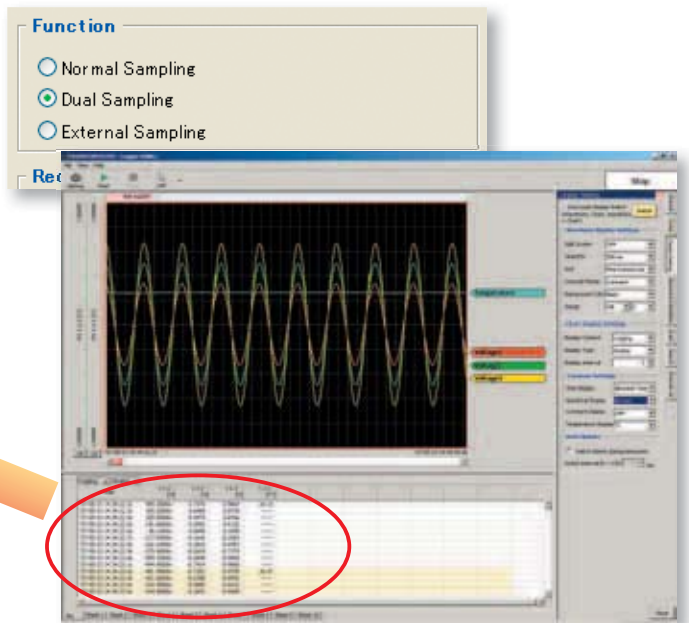

- Function**
- Normal Sampling
 - Dual Sampling
 - External Sampling

Enhanced PC Interface



USB Port Included

A USB 2.0 (mini-B connector) port is included as standard. The 8423 instrument and a PC can be connected by a USB cable (A to mini-B) for transferring 8423 operating settings and data.



LAN Terminal Included

A 100Base-TX LAN terminal is included as standard. The 8423 instrument and a PC can be connected by a LAN cable for transferring 8423 operating settings and data.

External Control Inputs Included



Input terminals are provided for external triggering, external start and stop and external sampling. External signals can be applied as a trigger source and to start and stop measurements, so data can be acquired by controlled sampling timing.

Note: External triggering and external sampling share a common terminal, so only one of these control input types can be used at a time.

More Functional Details

All-Channel Synchronous Measurement Capability

When measuring up to 120 channels on combined modules, all input channels are sampled synchronously. When multiple 8423s are connected via LAN or USB for measuring up to 600 channels, the sampling of each instrument in the system can be synchronized using optional Connection Cable Model 9683. As well as PC-based data collection, measurement start and stop can be controlled by the [START/MARK] and [STOP] keys on a master 8423.

Note: Any 8423 may be designated as the master. Only the initial acquisition criteria setting needs to be performed on a PC via USB or LAN.

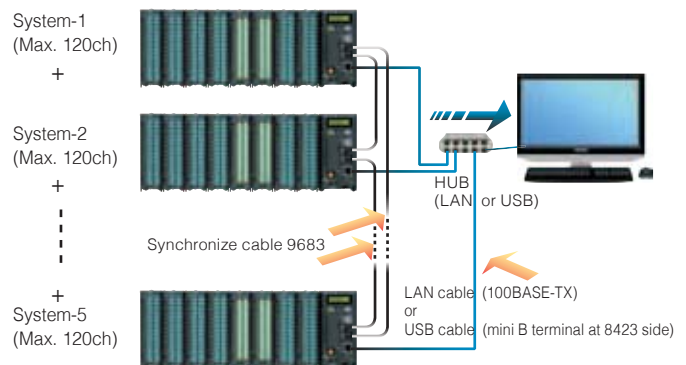

Enhanced Noise Immunity

A delta-sigma type A/D converter has been incorporated in the measurement circuitry. The effects of previously problematic inverter switching noise and 50/60 Hz hum noise have been greatly reduced by the digital filtering function using the oversampling principle inherent in this type of device.

Note: Optimum noise suppression is obtained with recording intervals of two seconds or longer

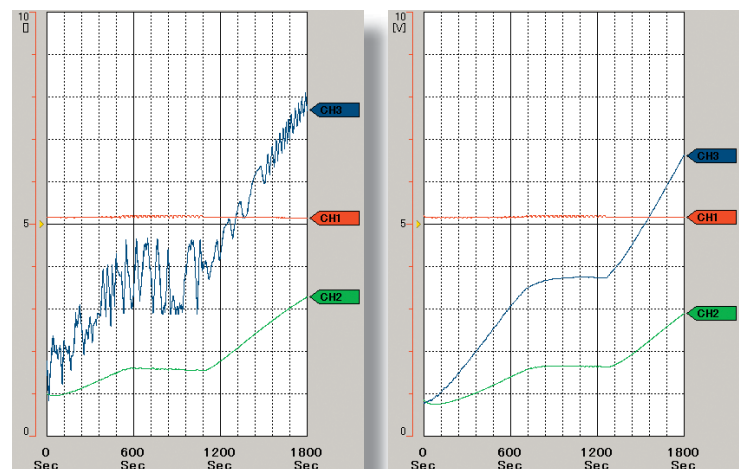

Product Specifications



8423 Hardware Specifications <small>(accuracy is specified @23 ±5°C/73 ±9°F, 30 to 80 % rh, from 30 minutes after power on, accuracy guaranteed for 1 year, Post-adjustment accuracy guaranteed for 1 year, product guaranteed for 1 year)</small>	
Display	LCD, 16 characters × 2 lines, 5 × 8 dots / characters
Memory capacity	Total 16 M-word (about 16.77 million data points: 32 mega-bytes)
External control connectors	Push-button type terminal block : External trigger/ External sampling input (exclusive OR), External start input, External stop input External sampling : rise-up, or fall-down (selectable) Rise-up : Low (0 to 1.0 V) to High (2.5 to 5.0 V) Fall-down : High (2.5 to 5.0 V) to Low (0 to 1.0 V), or terminal short Input voltage range : -5 to 10 V DC, Filter ON/OFF possible Pulse width response : Over 1 ms at "H", over 2 μs at "L" (at filter OFF), Over 2.5 ms at "H", over 4 ms at "L" (at filter ON) Maximum external sampling period : 10 ms (at digital filter OFF), 20 ms (at digital filter OFF, and synchronous measurement), 5 s (at digital filter ON, and combined with humidity measurement) Synchronous sampling : Five-units maximum for synchronous connection, Function : Connect via the connection cable model 9683 for synchronous sampling
Clock	Auto calendar, leap year auto distinguish, Precision : ±0.2s/ day at power ON, ±3s/ day at power OFF (at 23 °C/ 73°F)
Accuracy of timebase	±0.2s/ day on measurement (at 23 °C/ 73°F)
Recording intervals	10ms, 20ms, 50ms, 100ms, 200ms, 500ms, 1s, 2s, 5s, 10s, 20s, 30s, 1min, 2min, 5min, 10min, 20min, 30min, 1hr (5s to 1hr when combined with humidity measurement)
Recording length	Set to arbitrary length or continuous; Data storage : last 16-mega datas in internal memory (for one channel recording, For n channels, 16 M-datas / n data)
Recording mode	Continue, Repeat, Timer measurement
Number of data	For analog "n" channels, (16-mega datas / n) datas
Durability of battery	Backup battery for clock and setting conditions: battery life of at least 10 years, For measurement data: none (at 23 °C/ 73°F)
No. of connectable units	Maximum 8 units (total 120 channels)
Environmental conditions	Operating temperature and humidity : 0 (32°F) to 40°C (104°F), 30 to 80% rh, Storage temperature and humidity : -10 (14°F) to 50°C (122°F), 80% rh or less, (non-condensating)
Conforming standards	Safety : EN61010, EMC : EN61326, EN61000-3-2, EN61000-3-3
Power supply	(1) Using the AC ADAPTER 9418-15, 100 to 240 VAC, 50/60 Hz (2) External DC Power: 9.6 V to 15.6 VDC (Please contact HIOKI for connection cord)
Power consumption	Using the AC adapter 9418-15: 55 VA Max. (include AC adapter), 20 VA Max. (main unit only) (when connected with 8 units), External DC Power: 20 VA Max. (when connected with 8 units)
Dimensions & Mass	Approx. 67 mm (2.64 in) W × 133 mm (5.24 in) H × 125 mm (4.92 in) D, 600 g (21.2 oz)
Accessories	Operating Manual ×1, Quick Start Manual ×1, AC ADAPTER 9418-15 ×1, USB cable ×1, Connection Plate ×1, CD-R (data collection software "Logger Utility") ×1, Connector cover ×1, Ferrite clamp ×1
PC Interface	
Data storage media	CF card slot × 1 (Up to 1GB), MS-DOS format, <i>Note: Cannot use with the 9830 (2GB) card</i>
Interface	LAN : supports 100Base-TX, DHCP, DNS USB : Ver 2.0, mini-B receptacle
PC control	Data acquisition and measurement criteria settings are controlled by the PC data acquisition program; data acquired to internal memory and CF Cards is downloaded via FTP server function; simple operations (measurement start/stop and data acquisition to internal memory) are available via HTTP server function
Function Specifications	
Major Functions	Control the input units, or output units, Communication to the PC, Data storage to the CF card
Measurement parameters	Depending on the connected measurement unit: Temperature (thermocouple, Pt), voltage, humidity (used optional sensor), totalized pulses (addition, instantly), rotation count, digital signal
Real time save	Measurement data are saved as binary data to the CF Card in real time, and can be saved to separate files at preset times, selectable as full files or an endless loop with automatic deletion of oldest data.
Dual sampling	Two (high-speed and low-speed) recording intervals can be specified for every input module from the following: 10, 20, 50, 100, 200 and 500 ms; 1, 2, 5, 10, 20 and 30 s; 1, 2, 5, 10, 20 and 30 min; and 1 hr (the low-speed setting divided by the high-speed setting must be an integer less than 1,000)
Marking	Event mark input : Press [Start / Stop] key at measurement
Trigger function	Mode : Single / Repeat, Timing : Start / Stop / Start & Stop, Pre-Trigger : records period before trigger, can be set for real-time saving
Trigger source	Analog input : Maximum 120 channels, depend on number of the input unit. Pulse totalizer inputs : Maximum 120 channels, depend on number of the input unit. Logic inputs : Maximum 120 channels, depend on number of the input unit. External trigger : Rise up or fall down of the external input signal (selectable) Logical AND or OR for each trigger source, Trigger condition settable for each channels
Trigger type	Level : Triggers when rising or falling through preset level Window : Triggers when entering or exiting range defined by preset upper and lower limit values Trigger level resolution : 0.1 % f.s. Logic : 1, 0, × Pattern trigger
External trigger signal	Rise up : Low level (0 to 1.0 V) to High level (2.5 V to 5.0 V) Fall down : High level (2.5 V to 5.0 V) to Low level (0 to 1.0 V), or terminal short Input voltage range : -5 V to 10 V, Filter ON/OFF possible, Pulse width response : more than 1 ms (High period), more than 2 μs (Low period) at filter OFF, more than 2.5 ms (High period), more than 4 ms (Low period) at filter ON
Alarm output	Alarm Module 8997 can be connected along with various measurement modules (although it cannot be connected alone)
Alarm type	Level : Triggers when rising or falling through preset level Window : Triggers when entering or exiting range defined by preset upper and lower limit values Logic pattern : agreement (or disagreement) in the specified pattern Output latch settings : latch / no latch
Start backup	Possible

■ Specification

■ Bundled software specifications

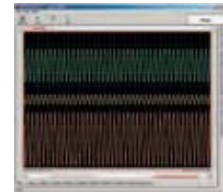

Logger Utility (bundled application software)	
Supported units	Model 8423, 8430-20, LR8431-20, LR8432-20, LR8400-20, LR8401-20, LR8402-20, and LR8410-20
Operating environment	Windows 10/8/7 (32bit/64bit), Vista (32bit/64bit), XP (with SP2 or later) (32bit)
Real-time data acquisition	Measurements on multiple loggers connected by LAN or USB can be controlled to sequentially acquire, display and save waveform data (for recording up to 10 million samples) Number of controllable instruments: up to 5 units (This software is compatible only with the LR8410-20, LR8400-20series, LR8431-20, 8423, and 8430-20) Display: Waveforms (time-axis divided display possible), numerical values (logging), and alarm status can be displayed at the same time Numerical value display: Can be monitored in a separate window Scroll: Waveform scroll while measuring Data saving destination: Real-time data transfer to Excel, or Real-time data acquisition file (LUW format) Event marks: Can be set while measuring
Data acquisition settings	Data acquisition settings for the logger or logging station Saving: The setting for multiple loggers or logging stations can be saved together in one file (LUS format); Instrument configuration settings can be sent and received
Waveform display	Processed data file: Real-time data acquisition file (LUW format), Record to internal memory data (MEM format) Display format: Simultaneously display waveform and numerical value, (time-axis divided display possible) Maximum number of channels: 675 channels (measurement data) + 60 channels (waveform processing data) Others: Display each channel's waveform on 10 sheets, scroll, record event mark, cursor, screen hard copy, numerical value display

Data conversion	Target data: Real-time data acquisition file (LUW format), record to internal memory data (MEM format) Converted sections: All data, designation section Format: CSV format (separate by comma, space, tab), transfer to Excel spreadsheet, arbitrary data thinning
Waveform processing	Processing items: Four arithmetic operations Number of processing channels: 60 channels
Parameter calculations	Target data: Real-time data acquisition file (LUW format), record to internal memory data (MEM format), data acquired in real time, waveform processing data Calculation items: Average, peak, maximum values, time to maximum values, minimum values, time to minimum values, ON time, OFF time, count the number of ON time and OFF time, standard deviation, integration, area values, totalization
Search functions	Target data: Real-time data acquisition file (LUW format), record to internal memory data (MEM format) Search mode: Event mark, time and date, maximum position, minimum position, maximum pole, minimum pole, alarm position, level, window, amount of change
Print functions	Supported printer: Printer compatible with the OS Target data: Real-time data acquisition file (LUW format), record to internal memory data (MEM format) Print format: Waveform image, report format, list print (channel settings, event, cursor value) Print area: The entire area, area between cursors A and B Print preview: Supported



VOLTAGE/TEMP UNIT 8948 (accuracy specified @ 23 ±5°C/73 ±9°F, 30 to 80% rh., from 30 minutes after power on and after zero point adjustment, accuracy and Post-adjustment accuracy and product guaranteed for 1 year)

Input	Measurement parameters : Voltage, Thermocouples (K, E, J, T, N, W, R, S, B) Terminal : M3 (mm) screw terminals (2 terminals/1ch), terminal block removable, supplied terminal block cover Number of channels : 15 channels isolated from each other and chassis, (voltage or thermocouple selectable for each channels) Input impedance: 1MΩ (850kΩ when open-circuit polling is enabled)																																																																																																					
Measurement parameters	Voltage	<table border="1"> <thead> <tr> <th>Setting Range</th> <th>Measurement range</th> <th>Resolution</th> <th>Accuracy</th> </tr> </thead> <tbody> <tr> <td>100mV f.s.</td> <td>-150mV to +150mV</td> <td>5μV</td> <td rowspan="6">±0.1% f.s. <i>Note: at 1-5 V range, f.s.=10 V</i></td> </tr> <tr> <td>1V f.s.</td> <td>-1.5V to +1.5V</td> <td>50μV</td> </tr> <tr> <td>10V f.s.</td> <td>-15V to +15V</td> <td>500μV</td> </tr> <tr> <td>20V f.s.</td> <td>-30V to +30V</td> <td>1mV</td> </tr> <tr> <td>100V f.s.</td> <td>-100V to +100V</td> <td>5mV</td> </tr> <tr> <td>1-5V f.s.</td> <td>1V to 5V</td> <td>500μV</td> </tr> </tbody> </table>	Setting Range	Measurement range	Resolution	Accuracy	100mV f.s.	-150mV to +150mV	5μV	±0.1% f.s. <i>Note: at 1-5 V range, f.s.=10 V</i>	1V f.s.	-1.5V to +1.5V	50μV	10V f.s.	-15V to +15V	500μV	20V f.s.	-30V to +30V	1mV	100V f.s.	-100V to +100V	5mV	1-5V f.s.	1V to 5V	500μV	<table border="1"> <thead> <tr> <th>Setting Range</th> <th>Measurement range</th> <th>Resolution</th> <th>Accuracy</th> </tr> </thead> <tbody> <tr> <td>R 100°C f.s.</td> <td>0°C to 100°C</td> <td>0.01°C</td> <td rowspan="10">±0.05% f.s. ±3.5°C (0°C to less than 400°C) (Temperatures less than 400°C measured by B thermocouples are not guaranteed for accuracy)</td> </tr> <tr> <td>R 500°C f.s.</td> <td>0°C to 500°C</td> <td>0.05°C</td> </tr> <tr> <td>R 2000°C f.s.</td> <td>0°C to 1700°C</td> <td>0.1°C</td> </tr> <tr> <td>S 100°C f.s.</td> <td>0°C to 100°C</td> <td>0.01°C</td> </tr> <tr> <td>S 500°C f.s.</td> <td>0°C to 500°C</td> <td>0.05°C</td> </tr> <tr> <td>S 2000°C f.s.</td> <td>0°C to 1700°C</td> <td>0.1°C</td> </tr> <tr> <td>B 2000°C f.s.</td> <td>0°C to 1800°C</td> <td>0.1°C</td> </tr> <tr> <td>W : WreS-26</td> <td></td> <td></td> </tr> <tr> <td>W 100°C f.s.</td> <td>0°C to 100°C</td> <td>0.01°C</td> </tr> <tr> <td>W 500°C f.s.</td> <td>0°C to 500°C</td> <td>0.05°C</td> </tr> <tr> <td>W 2000°C f.s.</td> <td>0°C to 2000°C</td> <td>0.1°C</td> </tr> </tbody> </table>	Setting Range	Measurement range	Resolution	Accuracy	R 100°C f.s.	0°C to 100°C	0.01°C	±0.05% f.s. ±3.5°C (0°C to less than 400°C) (Temperatures less than 400°C measured by B thermocouples are not guaranteed for accuracy)	R 500°C f.s.	0°C to 500°C	0.05°C	R 2000°C f.s.	0°C to 1700°C	0.1°C	S 100°C f.s.	0°C to 100°C	0.01°C	S 500°C f.s.	0°C to 500°C	0.05°C	S 2000°C f.s.	0°C to 1700°C	0.1°C	B 2000°C f.s.	0°C to 1800°C	0.1°C	W : WreS-26			W 100°C f.s.	0°C to 100°C	0.01°C	W 500°C f.s.	0°C to 500°C	0.05°C	W 2000°C f.s.	0°C to 2000°C	0.1°C																																						
	Setting Range	Measurement range	Resolution	Accuracy																																																																																																		
100mV f.s.	-150mV to +150mV	5μV	±0.1% f.s. <i>Note: at 1-5 V range, f.s.=10 V</i>																																																																																																			
1V f.s.	-1.5V to +1.5V	50μV																																																																																																				
10V f.s.	-15V to +15V	500μV																																																																																																				
20V f.s.	-30V to +30V	1mV																																																																																																				
100V f.s.	-100V to +100V	5mV																																																																																																				
1-5V f.s.	1V to 5V	500μV																																																																																																				
Setting Range	Measurement range	Resolution	Accuracy																																																																																																			
R 100°C f.s.	0°C to 100°C	0.01°C	±0.05% f.s. ±3.5°C (0°C to less than 400°C) (Temperatures less than 400°C measured by B thermocouples are not guaranteed for accuracy)																																																																																																			
R 500°C f.s.	0°C to 500°C	0.05°C																																																																																																				
R 2000°C f.s.	0°C to 1700°C	0.1°C																																																																																																				
S 100°C f.s.	0°C to 100°C	0.01°C																																																																																																				
S 500°C f.s.	0°C to 500°C	0.05°C																																																																																																				
S 2000°C f.s.	0°C to 1700°C	0.1°C																																																																																																				
B 2000°C f.s.	0°C to 1800°C	0.1°C																																																																																																				
W : WreS-26																																																																																																						
W 100°C f.s.	0°C to 100°C	0.01°C																																																																																																				
W 500°C f.s.	0°C to 500°C	0.05°C																																																																																																				
W 2000°C f.s.	0°C to 2000°C	0.1°C																																																																																																				
Thermocouples	<table border="1"> <thead> <tr> <th>Setting Range</th> <th>Measurement range</th> <th>Resolution</th> <th>Accuracy</th> </tr> </thead> <tbody> <tr> <td>K 100°C f.s.</td> <td>-100°C to 100°C</td> <td>0.01°C</td> <td rowspan="16">±0.05% f.s. ±1°C</td> </tr> <tr> <td>K 500°C f.s.</td> <td>-200°C to 500°C</td> <td>0.05°C</td> </tr> <tr> <td>K 2000°C f.s.</td> <td>-200°C to 1350°C</td> <td>0.1°C</td> </tr> <tr> <td>E 100°C f.s.</td> <td>-100°C to 100°C</td> <td>0.01°C</td> </tr> <tr> <td>E 500°C f.s.</td> <td>-200°C to 500°C</td> <td>0.05°C</td> </tr> <tr> <td>E 2000°C f.s.</td> <td>-200°C to 1000°C</td> <td>0.1°C</td> </tr> <tr> <td>J 100°C f.s.</td> <td>-100°C to 100°C</td> <td>0.01°C</td> </tr> <tr> <td>J 500°C f.s.</td> <td>-200°C to 500°C</td> <td>0.05°C</td> </tr> <tr> <td>J 2000°C f.s.</td> <td>-200°C to 1200°C</td> <td>0.1°C</td> </tr> <tr> <td>T 100°C f.s.</td> <td>-100°C to 100°C</td> <td>0.01°C</td> </tr> <tr> <td>T 500°C f.s.</td> <td>-200°C to 400°C</td> <td>0.05°C</td> </tr> <tr> <td>T 2000°C f.s.</td> <td>-200°C to 400°C</td> <td>0.1°C</td> </tr> <tr> <td>N 100°C f.s.</td> <td>-100°C to 100°C</td> <td>0.01°C</td> </tr> <tr> <td>N 500°C f.s.</td> <td>-200°C to 500°C</td> <td>0.05°C</td> </tr> <tr> <td>N 2000°C f.s.</td> <td>-200°C to 1300°C</td> <td>0.1°C</td> </tr> </tbody> </table>	Setting Range	Measurement range	Resolution	Accuracy	K 100°C f.s.	-100°C to 100°C	0.01°C	±0.05% f.s. ±1°C	K 500°C f.s.	-200°C to 500°C	0.05°C	K 2000°C f.s.	-200°C to 1350°C	0.1°C	E 100°C f.s.	-100°C to 100°C	0.01°C	E 500°C f.s.	-200°C to 500°C	0.05°C	E 2000°C f.s.	-200°C to 1000°C	0.1°C	J 100°C f.s.	-100°C to 100°C	0.01°C	J 500°C f.s.	-200°C to 500°C	0.05°C	J 2000°C f.s.	-200°C to 1200°C	0.1°C	T 100°C f.s.	-100°C to 100°C	0.01°C	T 500°C f.s.	-200°C to 400°C	0.05°C	T 2000°C f.s.	-200°C to 400°C	0.1°C	N 100°C f.s.	-100°C to 100°C	0.01°C	N 500°C f.s.	-200°C to 500°C	0.05°C	N 2000°C f.s.	-200°C to 1300°C	0.1°C	<table border="1"> <thead> <tr> <th>Setting Range</th> <th>Measurement range</th> <th>Resolution</th> <th>Accuracy</th> </tr> </thead> <tbody> <tr> <td>K 100°C f.s.</td> <td>-100°C to 100°C</td> <td>0.01°C</td> <td rowspan="16">±0.05% f.s. ±1°C</td> </tr> <tr> <td>K 500°C f.s.</td> <td>-200°C to 500°C</td> <td>0.05°C</td> </tr> <tr> <td>K 2000°C f.s.</td> <td>-200°C to 1350°C</td> <td>0.1°C</td> </tr> <tr> <td>E 100°C f.s.</td> <td>-100°C to 100°C</td> <td>0.01°C</td> </tr> <tr> <td>E 500°C f.s.</td> <td>-200°C to 500°C</td> <td>0.05°C</td> </tr> <tr> <td>E 2000°C f.s.</td> <td>-200°C to 1000°C</td> <td>0.1°C</td> </tr> <tr> <td>J 100°C f.s.</td> <td>-100°C to 100°C</td> <td>0.01°C</td> </tr> <tr> <td>J 500°C f.s.</td> <td>-200°C to 500°C</td> <td>0.05°C</td> </tr> <tr> <td>J 2000°C f.s.</td> <td>-200°C to 1200°C</td> <td>0.1°C</td> </tr> <tr> <td>T 100°C f.s.</td> <td>-100°C to 100°C</td> <td>0.01°C</td> </tr> <tr> <td>T 500°C f.s.</td> <td>-200°C to 400°C</td> <td>0.05°C</td> </tr> <tr> <td>T 2000°C f.s.</td> <td>-200°C to 400°C</td> <td>0.1°C</td> </tr> <tr> <td>N 100°C f.s.</td> <td>-100°C to 100°C</td> <td>0.01°C</td> </tr> <tr> <td>N 500°C f.s.</td> <td>-200°C to 500°C</td> <td>0.05°C</td> </tr> <tr> <td>N 2000°C f.s.</td> <td>-200°C to 1300°C</td> <td>0.1°C</td> </tr> </tbody> </table>	Setting Range	Measurement range	Resolution	Accuracy	K 100°C f.s.	-100°C to 100°C	0.01°C	±0.05% f.s. ±1°C	K 500°C f.s.	-200°C to 500°C	0.05°C	K 2000°C f.s.	-200°C to 1350°C	0.1°C	E 100°C f.s.	-100°C to 100°C	0.01°C	E 500°C f.s.	-200°C to 500°C	0.05°C	E 2000°C f.s.	-200°C to 1000°C	0.1°C	J 100°C f.s.	-100°C to 100°C	0.01°C	J 500°C f.s.	-200°C to 500°C	0.05°C	J 2000°C f.s.	-200°C to 1200°C	0.1°C	T 100°C f.s.	-100°C to 100°C	0.01°C	T 500°C f.s.	-200°C to 400°C	0.05°C	T 2000°C f.s.	-200°C to 400°C	0.1°C	N 100°C f.s.	-100°C to 100°C	0.01°C	N 500°C f.s.	-200°C to 500°C	0.05°C	N 2000°C f.s.	-200°C to 1300°C	0.1°C
Setting Range	Measurement range	Resolution	Accuracy																																																																																																			
K 100°C f.s.	-100°C to 100°C	0.01°C	±0.05% f.s. ±1°C																																																																																																			
K 500°C f.s.	-200°C to 500°C	0.05°C																																																																																																				
K 2000°C f.s.	-200°C to 1350°C	0.1°C																																																																																																				
E 100°C f.s.	-100°C to 100°C	0.01°C																																																																																																				
E 500°C f.s.	-200°C to 500°C	0.05°C																																																																																																				
E 2000°C f.s.	-200°C to 1000°C	0.1°C																																																																																																				
J 100°C f.s.	-100°C to 100°C	0.01°C																																																																																																				
J 500°C f.s.	-200°C to 500°C	0.05°C																																																																																																				
J 2000°C f.s.	-200°C to 1200°C	0.1°C																																																																																																				
T 100°C f.s.	-100°C to 100°C	0.01°C																																																																																																				
T 500°C f.s.	-200°C to 400°C	0.05°C																																																																																																				
T 2000°C f.s.	-200°C to 400°C	0.1°C																																																																																																				
N 100°C f.s.	-100°C to 100°C	0.01°C																																																																																																				
N 500°C f.s.	-200°C to 500°C	0.05°C																																																																																																				
N 2000°C f.s.	-200°C to 1300°C	0.1°C																																																																																																				
Setting Range	Measurement range	Resolution		Accuracy																																																																																																		
K 100°C f.s.	-100°C to 100°C	0.01°C	±0.05% f.s. ±1°C																																																																																																			
K 500°C f.s.	-200°C to 500°C	0.05°C																																																																																																				
K 2000°C f.s.	-200°C to 1350°C	0.1°C																																																																																																				
E 100°C f.s.	-100°C to 100°C	0.01°C																																																																																																				
E 500°C f.s.	-200°C to 500°C	0.05°C																																																																																																				
E 2000°C f.s.	-200°C to 1000°C	0.1°C																																																																																																				
J 100°C f.s.	-100°C to 100°C	0.01°C																																																																																																				
J 500°C f.s.	-200°C to 500°C	0.05°C																																																																																																				
J 2000°C f.s.	-200°C to 1200°C	0.1°C																																																																																																				
T 100°C f.s.	-100°C to 100°C	0.01°C																																																																																																				
T 500°C f.s.	-200°C to 400°C	0.05°C																																																																																																				
T 2000°C f.s.	-200°C to 400°C	0.1°C																																																																																																				
N 100°C f.s.	-100°C to 100°C	0.01°C																																																																																																				
N 500°C f.s.	-200°C to 500°C	0.05°C																																																																																																				
N 2000°C f.s.	-200°C to 1300°C	0.1°C																																																																																																				
A/D conversion	Resolution : 16 bit, Maximum sampling speed : 10 ms																																																																																																					
Filter function	Digital filter : OFF, 50 Hz, 60 Hz (With 50 and 60 Hz settings, the digital filter is automatically set according to recording interval)																																																																																																					
Max. allowable input	Max. allowable input : 100 V DC (maximum voltage between input terminals that does not cause damage), Max. rated voltage between channels : 200 V DC Max. rated voltage to earth : 600 V DC, AC (Upper limit voltage that does not cause damage when applied between input channel and chassis, and between each input channels)																																																																																																					
Conforming standards	Safety : EN61010, EMC : EN61326																																																																																																					
Dimensions & Mass	Approx. 38.5 mm (1.52 in) W × 133 mm (5.24 in) H × 141.2 mm (5.56 in) D mm, 550 g (19.4 oz)																																																																																																					
Accessories	Connection Plate x1, Operating Manual x1																																																																																																					

Standard reference contact

Accuracy with internal compensation, add to measurement accuracy	±0.5°C (K, E, J, T) ±1.0°C (N, R, S, B, W)
Switching	Switchable between internal and external

■ Specification



UNIVERSAL UNIT 8949		(accuracy specified @23 ±5°C/73 ±9°F, 30 to 80% rh., from 30 minutes after power on and after zero point adjustment, accuracy and Post-adjustment accuracy and product guaranteed for 1 year)			
Input	Measurement parameters : Voltage, Thermocouples (K, E, J, T, N, W, R, S, B), Resistance temperature sensor (Pt 100, JPt 100), Humidity (only use with the Model 9701 sensor) Terminal : Screw-type terminals (4 terminals/1ch), terminal block removable, supplied terminal block cover Number of channels : 15 channels (input type selectable for each channels), Isolated from each other and chassis (at voltage or thermocouples), Not isolated from each other and common GND (at resistance temperature sensor or humidity) Input impedance: 1MΩ (850kΩ when open-circuit polling is enabled at thermocouples), 2MΩ (when resistance temperature sensor)				
Measurement parameters	Voltage	Setting Range	Measurement range	Resolution	Accuracy
	100mV f.s.	-150mV to +150mV	5μV	±0.1% f.s. <i>Note: at 1-5 V range, f.s.=10 V</i>	
1V f.s.	-1.5V to +1.5V	50μV			
10V f.s.	-15V to +15V	500μV			
20V f.s.	-30V to +30V	1mV			
100V f.s.	-60V to +60V	5mV			
1-5V f.s.	1V to 5V	500μV			
Thermocouples	Setting Range	Measurement range	Resolution	Accuracy	
	R 100°C f.s.	0°C to 100°C	0.01°C	±0.05% f.s. ±3.5°C (0°C to less than 400°C) (Temperatures less than 400°C measured by B thermocouples are not guaranteed for accuracy)	
R 500°C f.s.	0°C to 500°C	0.05°C			
R 2000°C f.s.	0°C to 1700°C	0.1°C			
S 100°C f.s.	0°C to 100°C	0.01°C			
S 500°C f.s.	0°C to 500°C	0.05°C			
S 2000°C f.s.	0°C to 1700°C	0.1°C			
B 2000°C f.s.	0°C to 1800°C	0.1°C			
W : Wre5-26					
W 100°C f.s.	0°C to 100°C	0.01°C			
W 500°C f.s.	0°C to 500°C	0.05°C			
W 2000°C f.s.	0°C to 2000°C	0.1°C			
Standard reference contact accuracy with internal compensation, add to measurement accuracy		±0.5°C (K, E, J, T)		±1.0°C (N, R, S, B, W)	
Switching		Switchable between internal and external			
Resistance temperature sensor Pt 100, JIS C 1604-1997	Setting Range	Measurement range	Resolution	Accuracy	
	100°C f.s.	-100°C to 100°C	0.01°C	±0.05% f.s. ±0.5°C	
500°C f.s.	-200°C to 500°C	0.05°C			
2000°C f.s.	-200°C to 800°C	0.1°C			
Resistance temperature sensor JPt 100, JIS C 1604-1989	Setting Range	Measurement range	Resolution	Accuracy	
	100°C f.s.	-100°C to 100°C	0.01°C	±0.05% f.s. ±0.5°C	
500°C f.s.	-200°C to 500°C	0.05°C			
2000°C f.s.	-200°C to 500°C	0.1°C			
Humidity		100% rh	5.0 to 95.0% rh	0.1% rh	Refer to the accuracy table
A/D conversion	Resolution : 16 bit, Maximum sampling speed : 10 ms (5 s when combined with humidity measurement)				
Filter function	Digital filter : OFF, 50 Hz, 60 Hz (With 50 and 60 Hz settings, the digital filter is automatically set according to recording interval)				
Max. allowable input	Max. allowable input : 60 V DC (maximum voltage between input terminals that does not cause damage), Max. rated voltage between channels : 120 V DC Max. rated voltage to earth : 600 V DC, AC (Upper limit voltage that does not cause damage when applied between input channel and chassis, and between each input channels)				
Conforming standards	Safety : EN61010, EMC : EN61326				
Dimensions & Mass	Approx. 38.5 mm (1.52 in) W × 133 mm (5.24 in) H × 141.2 mm (5.56 in) D mm, 530 g (18.7 oz)				
Accessories	Flat-blade Screwdriver x1 (for terminal block), Connection Plate x1, Operating Manual x1				

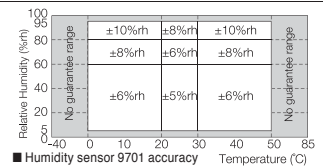

DIGITAL/PULSE UNIT 8996		(product guaranteed for one year)			
Input	Input signal condition : No-voltage 'a' contact (normally open contact), open collector or voltage input, Digital / Pulse input selectable for each channels Measurement parameters : Voltage, Totalized pulses (integrated or instantaneous), Rotation count, ON/OFF digital signal Terminal : M3 (mm) screw terminals (2 terminals/1ch), terminal block removable, supplied terminal block cover Number of channels : 15 channels (digital / pulse selectable for each channels) (common ground for CH-1 to CH-5, common ground for CH-6 to CH-10, common ground for CH-11 to CH-15) Input impedance : 1.1MΩ				
Pulse input	Totalized pulses	Setting Range	Measurement range	Resolution	Pulse input period with filter OFF 200 μs or more (both H and L periods must be at least 100 μs) with filter ON 100 ms or more (both H and L periods must be at least 50 ms)
	Rotation count	1.000M pulse f.s.	0 to 1,000M pulse	1 pulse	
Digital input	Logic detection level	HIGH = at least 1.0 V, LOW = 0 to 0.5 V	Filter Chatter-prevention filter : can be set ON/OFF for each channels Slope Rising or falling edge can be set for each channel Detection level HIGH = at least 1.0 V, LOW = 0 to 0.5 V HIGH = at least 4.0 V, LOW = 0 to 1.5 V		
		HIGH = at least 4.0 V, LOW = 0 to 1.5 V			
Max. allowable input	50 V DC (maximum voltage between input terminals that does not cause damage)				
Max. rated voltage to earth	600 V DC, AC (Upper limit voltage that does not cause damage when applied between CH-1 to CH-5 each channel and chassis, CH-6 to CH-10 each channel and chassis, CH-11 to CH-15 each channel and chassis, and between each UNITS)				
Max. rated voltage to each channels	33 V AC rms, 70 V DC (Upper limit voltage that does not cause damage when applied between CH-1 to CH-5 each channel and CH-6 to CH-10 each channel, CH-6 to CH-10 each channel and CH-11 to CH-15 each channel, CH-1 to CH-5 each channel and CH-11 to CH-15 each channel)				
Conforming standards	Safety : EN61010, EMC : EN61326				
Dimensions & Mass	Approx. 38.5 mm (1.52 in) W × 133 mm (5.24 in) H × 141.2 mm (5.56 in) D mm, 500 g (17.6 oz)				
Accessories	Connection Plate x1, Operating Manual x1				

ALARM UNIT 8997		(product guaranteed for one year)			
Output	Output type : open collector (active low) Alarm parameters : Use up to 15 channels in response to analog input, pulse input, rotation count, or ON/OFF digital signal Terminal : M3 (mm) screw terminals (2 terminals/1ch) Number of channels : 15 channels isolated from each other and chassis				
Output sink current	Maximum switching capability : 5 to 60 V DC @10 mA (open collector drive)				
Output refresh	Output latch settings : Latch / No latch at every recording interval				
Max. rated voltage to earth	600 V DC, AC (Upper limit voltage that does not cause damage when applied between each output channel and chassis, and between each units)				
Max. rated voltage to each channels	33 V AC rms, 70 V DC (Upper limit voltage that does not cause damage when applied between each output channels)				
Conforming standards	Safety : EN61010, EMC : EN61326				
Dimensions & Mass	Approx. 38.5 mm (1.52 in) W × 133 mm (5.24 in) H × 141.2 mm (5.56 in) D mm, 500 g (17.6 oz)				
Accessories	Connection Plate x1, Operating Manual x1				





Model : MEMORY HiLOGGER 8423
 Model No. (Order Code) (Note)
8423 (main unit only)
 Note: 8423 cannot operate alone. You must install one or more optional input modules in the unit. Thermocouples are not provided by HIOKI, and must be purchased from a separate vendor.

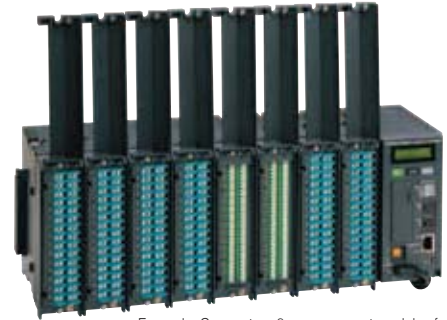

Example: Connect up 8 measurement modules for a 120-channel system

Input/output modules

VOLTAGE/TEMP UNIT 8948 15-channels, Voltage, Thermocouple input	UNIVERSAL UNIT 8949 15-channels, Voltage, Thermocouple, Resistance temperature sensor, Humidity measurement	DIGITAL/PULSE UNIT 8996 15-channels, ON/OFF logic signal, Totalized pulses (integrated or instantaneous), Rotation count	ALARM UNIT 8997 15-channels, Open-collector output
---	---	--	--

Input options

HUMIDITY SENSOR 9701 1-channel, for Universal unit 8949	Thermocouple *For reference only. Please purchase locally.
---	--

Storage media

* PC CARD 2G 9830 : cannot use with the 8423 * Supplied with PC Card adapter

PC Card Precaution
Use only PC Cards sold by HIOKI. Compatibility and performance are not guaranteed for PC cards made by other manufacturers. You may be unable to read from or save data to such cards.

PC CARD 1G 9729 1 GB capacity	PC CARD 512M 9728 512 MB capacity
---	---

Other options

*9418-15 is supplied as standard

AC ADAPTER 9418-15 100 to 240V AC	CONNECTION CABLE 9683 For synchronization, cable length 1.5 m (4.92 ft)
---	---

For the PC

*LOGGER UTILITY is a bundled software

LOGGER UTILITY SF1000 The control of the measurement of loggers, real-time data collection	LAN CABLE 9642 Straight Ethernet cable, supplied with straight to cross conversion adapter, 5 m (16.41 ft) length
--	---

■ Appearance/Dimension Illustration

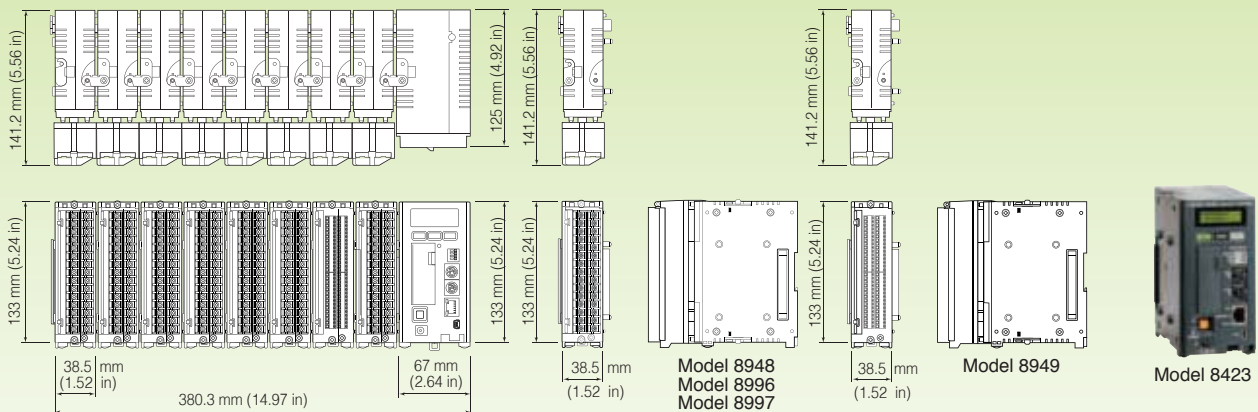

■ Configuration Examples

Input unit x 1 15-channels Isolated	Input unit x 2 30-channels Isolated	Input unit x 4 60-channels Isolated	Input unit x 8 120-channels Isolated	(Input unit x 8) system x 2 240-channels Isolated	(Input unit x 8) system x 4 480-channels Isolated	(Input unit x 8) system x 5 600-channels Isolated
Model 8423 x 1 Model 8948 x 1	Model 8423 x 1 Model 8948 x 2	Model 8423 x 1 Model 8948 x 4	Model 8423 x 1 Model 8948 x 8	Model 8423 x 2 Model 8948 x 16 Synchronization cable 9683 x 2	Model 8423 x 4 Model 8948 x 32 Synchronization cable 9683 x 4	Model 8423 x 5 Model 8948 x 40 Synchronization cable 9683 x 5

Note: Company names and Product names appearing in this catalog are trademarks or registered trademarks of various companies.



HIOKI

WIRELESS MINI LOGGER LR8512, LR8513, LR8514, LR8515, LR8520



For easy-to-use loggers, look no further!

Connect to a tablet, smartphone,
or PC for easy, wireless data collection



 **Bluetooth®**
Please see www.hioki.com for
list of supported regions.

asita
TECNOLOGIE DI MISURA

Connect to a tablet, smartphone, or PC for easy, wireless data collection

Use your tablet or PC to collect data even as signals are being logged.

Check data immediately and on-site.

No more complicated logger registration. Just touch to detect, and touch to register.



■ Real-time monitoring



Wireless Communication

LR8410-20



By using the Hioki LR8410-20 to acquire data, you can view the waveforms in real time. Furthermore, previous waveforms can be viewed while the device is taking measurements.

WIRELESS LOGGING STATION LR8410-20

■ Specifications

Supported devices	WIRELESS LOGGING STATION LR8410-20
Communication range	30 m (line of sight)
Number of available registrations	Max. 7 units

asita

TECNOLOGIE DI MISURA

Tablet, Smartphone Android Terminal

Operating procedure

1 Setting and measurement

Use your Android terminal to set and send measurement conditions such as the recording interval, to the logger to begin measurement.



*Settings cannot be changed directly on the logger.

2 Data collection

Collect the data recorded in the logger after or even during measurement.



3 Data analysis

Connect a USB cable to transfer the data to a PC. Use the bundled software, "Logger Utility," to perform analysis.



Specifications

Supported devices	Android tablet / Android smartphone
Communications	Bluetooth®2.1 + EDR
Android OS	4.0.3 or later
Number of available registrations	Max. 100 units
Recommended display size	7 inches or larger
Software	Collection: Wireless Logger Collector for Android Analysis: Logger Utility (PC)
Software acquisition	Collection: Download from Google Play Analysis: Supplied CD-R / Download from HIOKI's website

Setting screens

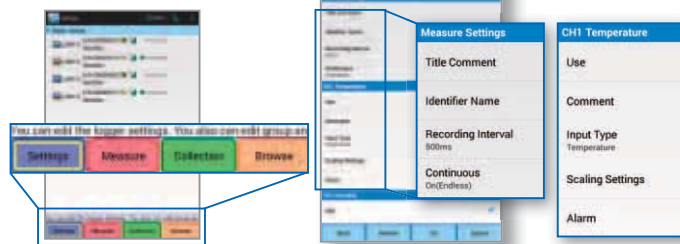

Waveform monitoring

Even during measurement, you can check recent data trends in waveform and values. This is also convenient for checking the levels before actual recording.



Portable and convenient

The user interface is perfect for the small screens of tablets or smartphones.

Check waveforms on-site

You can check the collected data on your tablet or smartphone.

Computer Windows PC

Operating procedure

1 Setting and measurement

Use your Windows PC to set and send measurement conditions such as the recording interval, to the logger to begin measurement.



*Settings cannot be changed directly on the logger.

2 Data collection

Collect the data recorded in the logger after or even during measurement.



3 Data analysis

Start "Logger Utility" and perform analysis at the touch of a button.

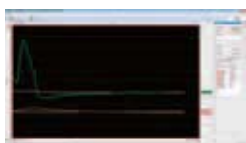

Specifications

Supported devices	Windows PC / Windows tablet
Communications	Bluetooth®2.1 + EDR
OS	Windows 10 / 8 / 7 / Vista (32/64bit)
Number of available registrations	Max. 100 units
Software	Collection: Wireless Logger Collector Analysis: Logger Utility
Software acquisition	Supplied CD-R / Download from HIOKI's website

Periodic collection

You can automatically collect data at intervals from 10 minutes to 1 day. Avoid the trouble of going around to collect data.

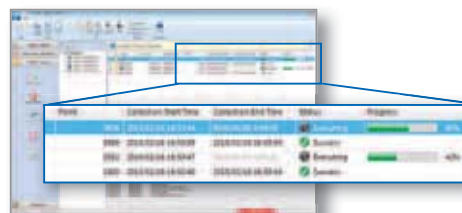

Status monitoring

You can periodically monitor information such as the latest measurement, remaining battery power, and signal strength.

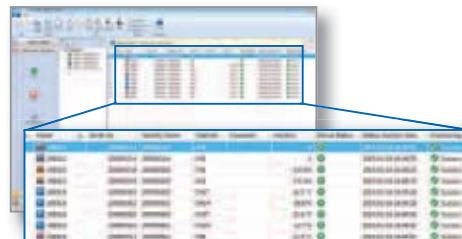

Multi-device management

Centrally manage up to 100 loggers. Since you can group devices in a tree structure, management is very easy.

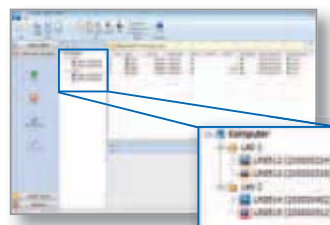

Here's why the "WIRELESS MINI" is for you

Select from 5 types to match your application.

All models have 2 channels*, with built-in high-capacity memory for long-term recording. Compact and space-saving, the mini loggers can be easily installed in locations where wiring is difficult.

*The LR8520 has 1 channel of input and 1 channel of alarm output.



Pulse : LR8512



Load/leakage current : LR8513



Temperature/humidity : LR8514, LR8520



Voltage / temperature : LR8515

Wireless

30 m line-of-sight, up to 100 devices

Built-in Bluetooth® wireless technology. Communication reaches 30 m, line-of-sight. (This varies depending on the performance of the communicating tablet or PC.) Manage up to 100 devices.

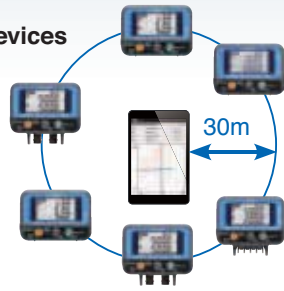

Automatic synthesis of acquired data into a single piece of data

No matter what time during measurement you collect the data, data is automatically merged together into one single file. You don't need to manually synthesize data.

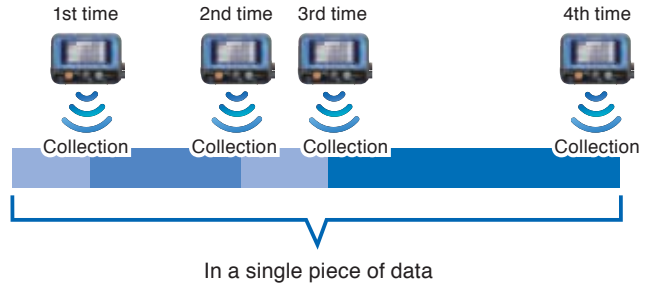

Make measurements inside panels or other difficult-to-wire locations

Installing a data logger in a switchboard or control panel has never been easier. Gone is the need to feed wiring through the panel—data collection is done wirelessly so you can close the panel door for safe measurements.

The loggers are also useful for measuring in difficult-to-wire locations, like high places or on moving machines.

Compact with Built-in High-capacity Memory

Install in tight spaces

Pocket size for installation anywhere. Use the optional MAGNETIC STRAP to hang it on a wall – solving all of your installation space problems.



2 channels built in all models

All models have 2-channels built in, so you can measure 2 locations simultaneously. With the LR8515, you can measure both voltage and temperature with a single device. *The LR8520 has 1 channel of input and 1 channel of alarm output.

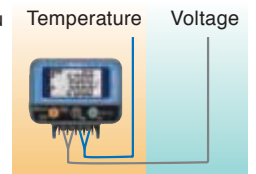

Record up to 500,000 pieces of data per channel

Despite their compact size, the mini loggers' built-in high-capacity memory offers plenty of space for you to perform long-term recording with peace of mind.

Recording intervals	Recordable time
0.1 sec	13 hr, 53 min, 20 sec
1 sec	5 days, 18 hr, 53 min, 20 sec
10 sec	57 days, 20 hr, 53 min, 20 sec
1 min	347 days, 5 hr, 20 min, 00 sec
2 min to 60 min	Over 365 days

Selectable recording modes

One time recording:

Once the memory is full, the logger stops recording. Prevents data from being overwritten and protects important data.

Endless recording:

Once the memory is full, the logger begins overwriting old data. You can always keep the latest 500,000 pieces of data.

Free Run NEW

Excluding LR8512

Update the current value display even while measurement is stopped

ON/ OFF selection. The measurement value is indicated every 1 second while measurement is stopped. (the data is not saved in the memory.) The measurement value is saved in the memory every recording interval and indicated every 1 second regardless of recording interval setting while measuring. (when the setting of recording interval is less than 1 second, the measurement value is indicated every recording interval)

Power-saving Design

Power-saving function for longer battery life

Set to turn on the Bluetooth® only during a pre-set time period. The shorter the power is on, the longer the battery will last.

Example: To configure the instrument so that Bluetooth® is automatically turned on from 9:00 am to 12:00 pm every day, allowing data to be captured during that time period [Settings] Schedule: Daily, Data reception start time: 9:00 am, Reception time: 3 hr.

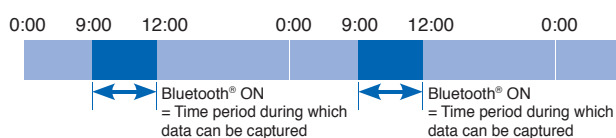

Continuous operating time (Battery)

Detailed conditions: Recording interval, Bluetooth® on/off

Conditions	LR8512	LR8513	LR8514, LR8520	LR8515
1 min, OFF	2 months	3 months	3.5 months	2.5 months
1 sec, OFF	2 months	1 months	3 months	10 days
1 sec, ON	14 days	10 days	20 days	7 days

*When Bluetooth® is constantly on or constantly off.

*When using the free run function, the continuous operating time is the same as when using a recording interval of 1 sec., even when measurement is stopped.

If recording for a long period of time, we recommend using the AC ADAPTER.



For pulse totalization and measuring logical ON/OFF signals or revolutions

WIRELESS PULSE LOGGER LR8512



For applications such as:

Air conditioning (flow rate), automobiles (flow rate, vehicle speed), cogeneration (flow rate)

Easily manage and record flow rates

Record and manage flow rates for liquids such as water, gas, and petroleum. You can measure the flow meter's output signal (pulse) to visualize daily fluctuations.



Specifications

(Accuracy guaranteed and Post-adjustment accuracy guaranteed for 1 year)

No. of input channels	2 channels (common GND)
Measurement modes	Integrating (cumulative/Instant), Revolution, Logic (Records an I/O for each recording interval)
Supported input format	Non-voltage "a" contact (always-open contact point), open collector, or voltage input (DC 0 V to 50 V)
Recording intervals	0.1 to 30 sec, 1 to 60 min, 16 selections
Recording modes	Instantaneous value
Dimensions, Weight	85W×61H×31D mm (3.35W×2.40H×1.22D in), 95 g (Not including the battery)

Pulse input

Pulse input cycle	200 μs or higher when the filter is set to OFF (must be 100 μs or higher in H period and L period.) 100 ms or higher when the filter is set to ON (must be 50 ms or higher in H period and L period.)		
Measurement objects	Range	Max. Resolution	Measurement Range
Totalization	1000M pulse f.s.	1 pulse	0 to 1000 M pulse
No. of revolutions	5000/n [r/s] f.s.	1/n [r/s]	0 to 5000/n [r/s]

*n is the number of pulses, 1 to 1000, per revolution.

Models and accessories

*AC Adapter is not included.

Model: WIRELESS PULSE LOGGER LR8512

Model No. (Order Code): LR8512

Accessories: CD-R (Instruction Manual, Logger Utility, Wireless Logger Collector) × 1, Measurement Guide × 1, Caution for Using Radio Waves × 1, AA alkaline batteries (LR6) × 2 Connection Cable L1010 × 2

Exclusive options

*Please see last page for shared options.

CONNECTION CABLE L1010
1.5 m (4.92 ft)
Bundled and also available for additional purchase



Supports voltage input and thermocouple types K and T with a single device

WIRELESS VOLTAGE/ TEMP LOGGER LR8515



For applications such as:

Various tests for electronics/automobiles/transportation, PV maintenance

Record voltage and temperature with a single device

You can use a single device to measure everything from the minute voltages of pyranometers or heat flow sensors to battery voltage.

Also view the correlation between voltage and temperature.



Specifications

(Accuracy guaranteed and Post-adjustment accuracy guaranteed for 1 year)

No. of input channels	2 ch (isolated; select voltage of thermocouple for each channel)
Measurement items	Voltage/ Thermocouple (K, T)
Input terminals	M3 screw type terminal block (2 terminals per channel)
Maximum input voltage	DC±50 V
Max. inter-channel voltage	DC 60 V
Recording intervals	0.1 to 30 sec, 1 to 60 min, 16 selections
Recording modes	Instantaneous value
Dimensions, Weight	85W×75H×38D mm (3.35W×2.95H×1.50D in), 126 g (Not including the battery)

Measurement ranges

Measurement objects	Range	Max. Resolution	Measurable Range	Measurement Accuracy	
Voltage	50 mV f.s.	0.01 mV	-50 mV to 50 mV	±0.05 mV	
	500 mV f.s.	0.1 mV	-500 mV to 500 mV	±0.5 mV	
	5 V f.s.	1 mV	-5 V to 5 V	±5 mV	
	50 V f.s.	10 mV	-50 V to 50 V	±50 mV	
Thermocouples	K	1000 °C f.s.	0.1 °C	-200 °C to -100 °C	±1.5 °C
				-100 °C to 999.9 °C	±0.8 °C
	T	1000 °C f.s.	0.1 °C	-200 °C to -100 °C	±1.5 °C
				-100 °C to 0 °C	±0.8 °C
				0 °C to 400 °C	±0.6 °C

Reference junction compensation: Switchable between internal and external

Reference junction compensation accuracy: ±0.5°C

(When using internal compensation, add to thermocouple measurement accuracy.)

Temperature characteristics: Add (measurement accuracy × 0.1)/°C to measurement accuracy.

Models and accessories

*Thermocouples and AC Adapter are not included.

Model: WIRELESS VOLTAGE/ TEMP LOGGER LR8515

Model No. (Order Code): LR8515

Accessories: CD-R (Instruction Manual, Logger Utility, Wireless Logger Collector) × 1, Measurement Guide × 1, Caution for Using Radio Waves × 1, AA alkaline batteries (LR6) × 2

*Please see last page for shared options.



For simple measurements such as AC/DC load current or AC leakage current

WIRELESS CLAMP LOGGER LR8513



For applications such as:

PV maintenance, automobile tests, forklifts, railroads, equipment maintenance

Built-in average value and maximum value recording modes

The logger can record the average or maximum value for each recording interval using RMS values measured at a 0.5 sec. interval. Average and maximum values are useful when assessing 30 min. demand and peak leakage current, respectively.

Simple electrical measurement

Set the voltage and power factor for simple electrical measurements. Direct reading on this device is possible for single-phase, two-wire systems.



Specifications (Accuracy guaranteed and Post-adjustment accuracy guaranteed for 1 year)

No. of input channels	2 channels (common GND)
Measurement items	AC load current, DC load current AC leak current (using current sensor)
Effective value calculation	Software calculates the true RMS value
Measurement ranges	AC500.0 mA to 2000 A (with current sensor) DC10.00 A to 2000 A (with current sensor) *Current and leak current that occur intermittently cannot be measured.
Measurement accuracy	±0.5% rdg.±5 dgt. (DC, AC 50/60 Hz) *Add the sensor's accuracy when the current sensor is connected
Recording intervals	0.5 to 30 sec, 1 to 60 min, 14 selections
Recording modes	Instantaneous value, average value, Maximum value recording
Dimensions, Weight	85W×75H×38D mm (3.35W×2.95H×1.50D in) mm, 130 g (Not including the battery)

Current sensor specifications (Using with LR8513)

Sensor used	Core jaw diameter	Range	Max. Resolution	Measurable Range
9675	φ30 mm	500.0 mA	0.1 mA	AC 1.0 mA to 500.0 mA
		5.000 A	0.001 A	AC 0.010 A to 5.000 A
9657-10	φ40 mm	500.0 mA	0.1 mA	AC 1.0 mA to 500.0 mA
		5.000 A	0.001 A	AC 0.010 A to 5.000 A
9695-02	φ15 mm	5.000 A	0.001 A	AC 0.010 A to 5.000 A
		50.00 A	0.01 A	AC 0.10 A to 50.00 A
CT6500	φ46 mm	50.00 A	0.01 A	AC 0.10 A to 50.00 A
		500.0 A	0.1 A	AC 1.0 A to 500.0 A
9669	φ55 mm	1000 A	1 A	AC 10 A to 1000 A
CT9667-01 CT9667-02 CT9667-03	-01: φ100 mm -02: φ180 mm -03: φ254 mm	500.0 A	0.1 A	AC 1.0 A to 500.0 A
		5000 A	1 A	AC 10 A to 5000 A
		50.00 A	0.01 A	AC 0.10 A to 50.00 A
CT7044 CT7045 CT7046	-44: φ100 mm -45: φ180 mm -46: φ254 mm	500.0 A	0.1 A	AC 1.0 A to 500.0 A
		5000 A	1 A	AC 10 A to 5000 A
		2000 A	0.01 A	AC 0.10 A to 2000 A
CT7631 CT7731	φ33 mm	10.00 A	0.01 A	AC 0.10 A to 10.00 A DC± (0.10 A to 10.00 A)
		100.0 A	0.1 A	AC 1.0 A to 100.0 A DC± (1.0 A to 100.0 A)
CT7636 CT7736	φ33 mm	20.00 A	0.01 A	AC 0.10 A to 20.00 A DC± (0.10 A to 20.00 A)
		200.0 A	0.1 A	AC 1.0 A to 200.0 A DC± (1.0 A to 200.0 A)
CT7642 CT7742	φ55 mm	200.0 A	0.1 A	AC 1.0 A to 200.0 A DC± (1.0 A to 200.0 A)
		2000 A	1 A	AC 10 A to 2000 A DC± (10 A to 2000 A)

Models and accessories

* Current sensor and AC Adapter are not included.

Model: WIRELESS CLAMP LOGGER LR8513







Model No. (Order Code): LR8513

Accessories: CD-R (Instruction Manual, Logger Utility, Wireless Logger Collector) × 1, Measurement Guide ×1, Caution for Using Radio Waves × 1, AA alkaline batteries (LR6) ×2

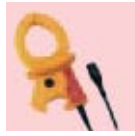
Exclusive options

* Please see last page for shared options.

Clamp sensors

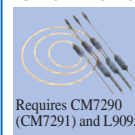
9675 	9657-10 	9695-02 Not CE Marked 	9219  For connecting the 9695-02
CT6500 	9669 	CT9667 	CT7044/ 45/ 46  Requires CM7290 (CM7291) and L9095

CONNECTION CABLE 9219	For connecting the 9695-02, cord length 3m
DISPLAY UNIT CM7290	For connecting the CT7000 series
DISPLAY UNIT CM7291	For connecting the CT7000 series, with Bluetooth® Smart
OUTPUT CORD L9095	For connecting the CT7000 series

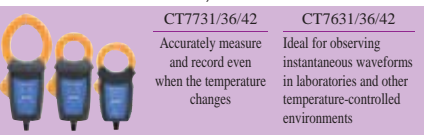
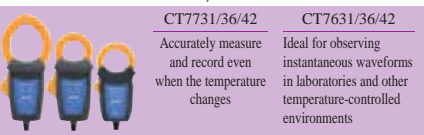
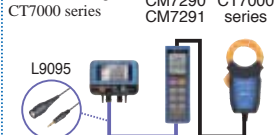
CT7731/ 36/ 42, CT7631/ 36/ 42  Accurately measure and record even when the temperature changes	CT7731/ 36/ 42, CT7631/ 36/ 42  Ideal for observing instantaneous waveforms in laboratories and other temperature-controlled environments	For connecting the CT7000 series CM7290 CM7291 CT7000 series 
---	---	--

Shared specifications LR8512, LR8513, LR8514, LR8515, LR8520

Control and communications	Bluetooth® 2.1+EDR (Communications range: 30 m, line of sight, security: SSP)	Safety	EN61010	
Storage capacity	500,000 data items for each channel	EMC	EN61326 classA, EN61000-3-2, EN61000-3-3	
Operating temperature and humidity	Temperature: -20 to 60 °C (-4 to 140 °F), Humidity: 80%rh or less (non-condensing) (Depends on battery and current sensor specifications when they are in use)	Applicable standards	Wireless certification Japan: Incorporates a wireless module that has been certified as compliant with applicable technical standards. US: Part 15.247 (Contains FCC ID: QQQWT111A) Canada:RSS-210 (Contains IC: 5123A-BGTWT111A) EU: EN 300 328, EN 301 489-1, EN 301 489-17	
Storage temperature and humidity	-20°C to 60°C, 80%rh or less (non-condensing) (With batteries removed)			
Functions	Alarm, Scaling, Recording operation hold function, Erroneous operation prevention, Comment recording function, Power saving function, Authentication function, Free Run (excluding LR8512)	Vibration endurance	JIS D 1601:1995 5.3(I), Category I: Vehicle, Condition: Category A equiv.	
Display items	Measurement value, date, time, number of recorded data, maximum value, minimum value, and average value	Power source	AC adapter	AC ADAPTER Z2003 (sold separately, DC 12 V)
			Battery	AA alkaline batteries (LR6) × 2
			External power	DC 5 V to 13.5 V * can also be supplied from USB bus power, with a conversion cable



Compact with High Accuracy, Convenient for Recording Temperature and Humidity

WIRELESS HUMIDITY LOGGER LR8514, LR8520



For applications such as:

Environmental testing, construction, factories, storage, agriculture

Conduct surveys and verifications efficiently

Easily record and manage the surrounding temperature and humidity. The logger is helpful for status analysis, improvement, and verification.

In addition, the LR8514 can simultaneously record the temperature and humidity in 2 locations, allowing you to compared conditions inside and outside a piece of equipment, for example. (With 2 sensors installed)



Recording temperature and humidity in a server room

Specifications

*Only the temperature and humidity sensors affect the measurement accuracy and are subject to calibration. The LR8514 and LR8520 loggers do not require calibration.

	LR8514	LR8520
No. of input channels	2 ch for temperature + 2 ch for humidity (2 sensors can be attached)	1 ch for temperature + 1 ch for humidity (1 sensors can be attached)
Measurement objects	Temperature, Humidity	Temperature, Humidity, fungal index (calculated based on temperature and relative humidity)
Output	--	Outputs alarm signals
Temperature measurement accuracy (using Z2010/Z2011)	±0.5° C (10 °C to 60 °C), using Z2010/ Z2011 If outside above temperature range: Add 0.015 °C/ °C (-40 °C to 10 °C) or 0.02° C/ °C (60 °C to 80 °C)	
Humidity measurement accuracy (using Z2010/Z2011)	±3% rh (20 °C to 30 °C, 20% to 90% rh) If outside above range, see Figure 1. Hysteresis: ±1% rh (Added to the humidity measurement accuracy)	
Recording intervals	0.5 to 30 sec, 1 to 60 min, 14 selections	
Recording modes	Instantaneous value	
Dimensions, Weight	85W×61H×31D mm (3.35W×2.40H×1.22D in), 95 g (Not including the battery)	

Measurement objects	Range	Max. Resolution	Measurable Range
Temperature	100 °C f.s.	0.1 °C	-40°C to 80 °C
Humidity	100%rh f.s.	0.1 %rh	0 % rh to 100 % rh

Humidity measurement accuracy (fig. 1)

The accuracy of values indicated by the * mark is not guaranteed (reference values).

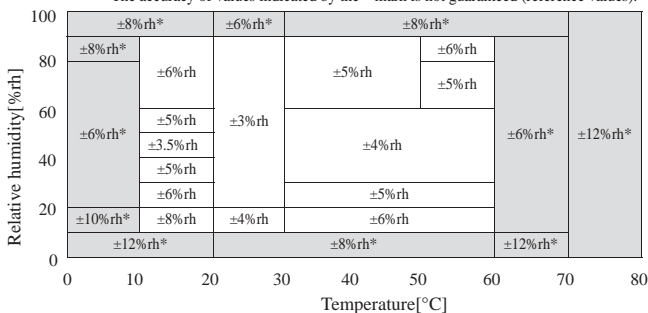

Models and accessories

* Temperature and humidity sensor , AC Adapter are not included.

Model: WIRELESS HUMIDITY LOGGER LR8514

Model No. (Order Code): LR8514

Accessories: CD-R (Instruction Manual, Logger Utility, Wireless Logger Collector) × 1, Measurement Guide × 1, Caution for Using Radio Waves × 1, AA alkaline batteries (LR6) × 2

Model: WIRELESS FUNGAL LOGGER LR8520

Model No. (Order Code): LR8520

Accessories: CD-R (Instruction Manual, Logger Utility, Wireless Logger Collector) × 1, Measurement Guide × 1, Caution for Using Radio Waves × 1, AA alkaline batteries (LR6) × 2, CONNECTION CABLE L1010 × 1

Exclusive options

*Please see below for shared options.



HUMIDITY SENSOR Z2010
50 mm (0.16 ft)



HUMIDITY SENSOR Z2011
1.5 m (4.92 ft)



CONNECTION CABLE L1010
1.5 m (4.92 ft)
Bundled and also available for additional purchase

Shared options



AC ADAPTER Z2003
100 to 240 VAC,
50/60Hz

For long-term recording



MAGNETIC STRAP Z5004



MAGNETIC STRAP Z5020
Extra strength

*The Bluetooth® word mark and logos are registered trademarks owned by Bluetooth SIG, Inc. and any use of such marks by HIOKI E.E. CORPORATION is under license.

Note: Company names and Product names appearing in this catalog are trademarks or registered trademarks of various companies.

HIOKI
HIOKI E. E. CORPORATION

HIOKI

DATA LOGGER LR5000 Series



Complete Line of Easy-to-Use Compact Loggers with Expanded Memory

The new HIOKI compact data logger series easily records temperature, voltage, current, and instrumentation signals over long periods. Carried over from its highly reputed predecessor, this series includes features and functions such as 7 times the recording capacity of former models, data import during recording, continuous measurement even during battery replacement, and intuitive PC software. Flexible and easy-to-use at single and multiple locations, the new HIOKI compact data logger series is ideal for any application that requires simple set-up but long-term, reliable recording capabilities.

CE

asita
TECNOLOGIE DI MISURA

Meet a Wide Variety of Data Logging Applications



Temperature Logger /Humidity Logger
 Manage the temperature and humidity in offices and factories. Visually monitor the data to save on air-conditioning and heating costs.

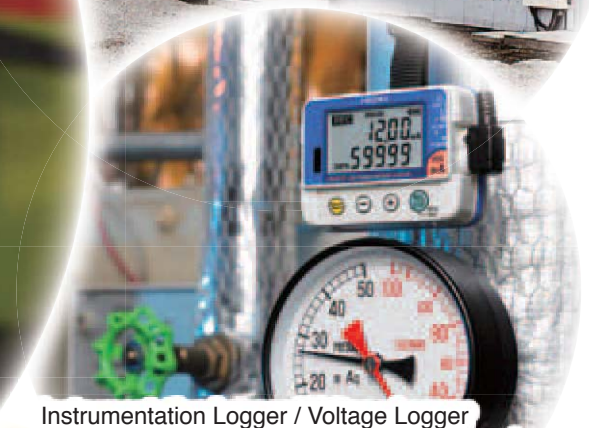

Instrumentation Logger / Voltage Logger
 Record fluid flow such as for water, gas and oil. Measure flow meter output signals to monitor flow trends.



Clamp Logger
 Manage the current consumption of plant and building equipment. Visually monitor power costs to efficiently conduct energy- and cost-saving activities.

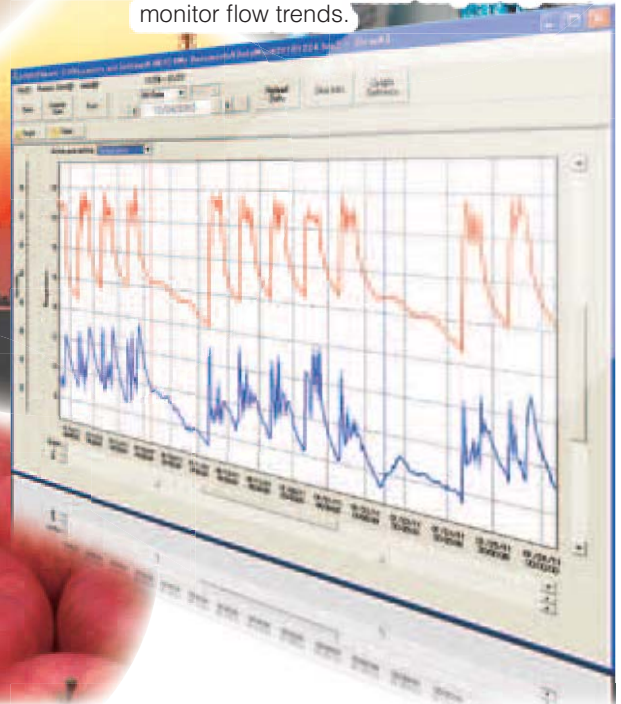

Use as a Voltage Logger to record pyranometer output for evaluating insulation.

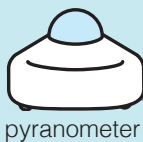

pyranometer

Voltage logger has a Preheat function

Use as a Clamp Logger and leakage sensor to record and monitor leakage trends.

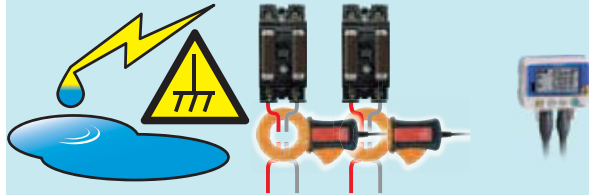

Use as a Temperature Logger to record warehouse temperatures for visually monitoring temperature changes of products and goods.



Use as an Instrumentation Logger to record pressure sensor output and monitor fluctuations in air or oil pressure.

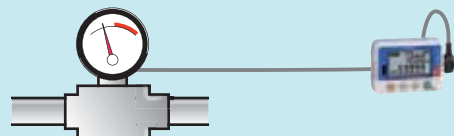

Easy operation in just 3 steps !



STEP 1

Set up & Record

Install a Data Logger, set an interval, and start measuring.

Easy to start recording



Set your recording interval. (from one second to 60 minutes)

Hold the REC button for two seconds to start recording.

Unlimited installation capabilities



Wall-mounted Holder (sold separately) Not usable with LR5051

Magnetic Strap (sold separately)

Kickstand (included, except for Model LR5051)



STEP 2

Transfer data from Data Logger to PC

Grab the Data Logger from the worksite and connect to a PC.

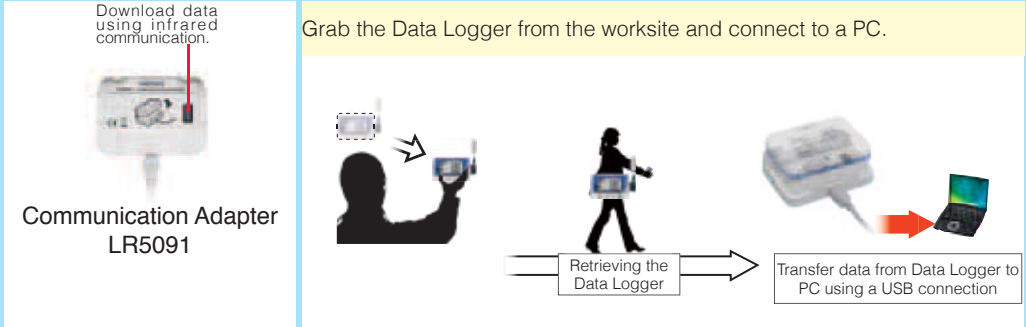

Download data using infrared communication.

Communication Adapter LR5091

Retrieving the Data Logger

Transfer data from Data Logger to PC using a USB connection

! Requires optional

Communication Adapter

or

Data Collector

Using the Data Collector's internal memory, import data from up to 16 Data Loggers installed on site.*

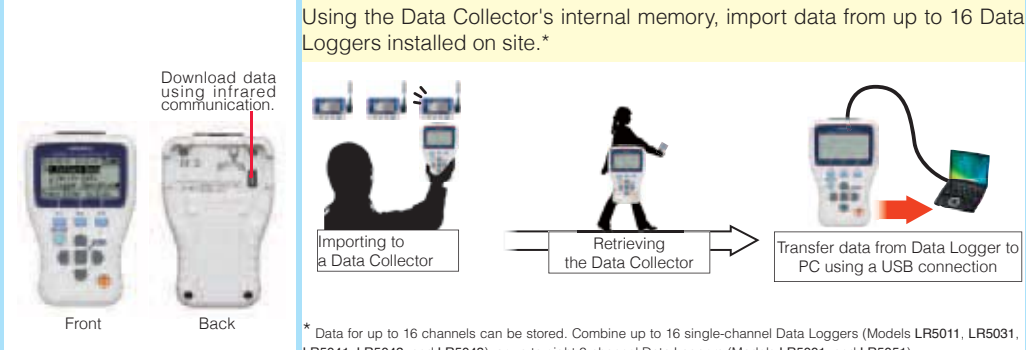

Download data using infrared communication.

Front Back

Data Collector LR5092-20

Importing to a Data Collector

Retrieving the Data Collector

Transfer data from Data Logger to PC using a USB connection

* Data for up to 16 channels can be stored. Combine up to 16 single-channel Data Loggers (Models LR5011, LR5031, LR5041, LR5042, and LR5043), or up to eight 2-channel Data Loggers (Models LR5001, and LR5051).

Top surface of LR5092-20

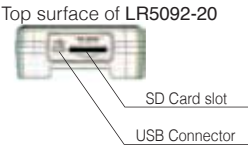

SD Card slot

USB Connector

Using an optional SD Memory Card, the amount of data that can be imported is practically limitless.

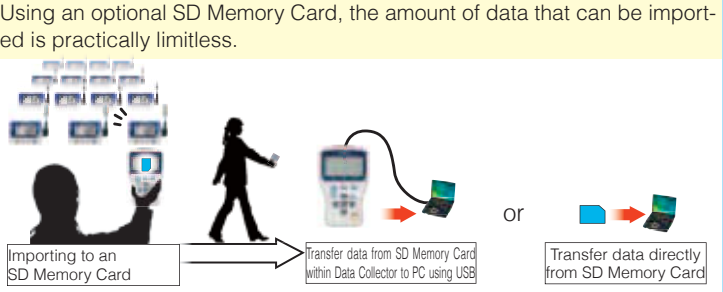

Importing to an SD Memory Card

Transfer data from SD Memory Card within Data Collector to PC using USB

or

Transfer data directly from SD Memory Card



STEP 3

View graphs and manage data

View data graphically and easily print using the bundled software.

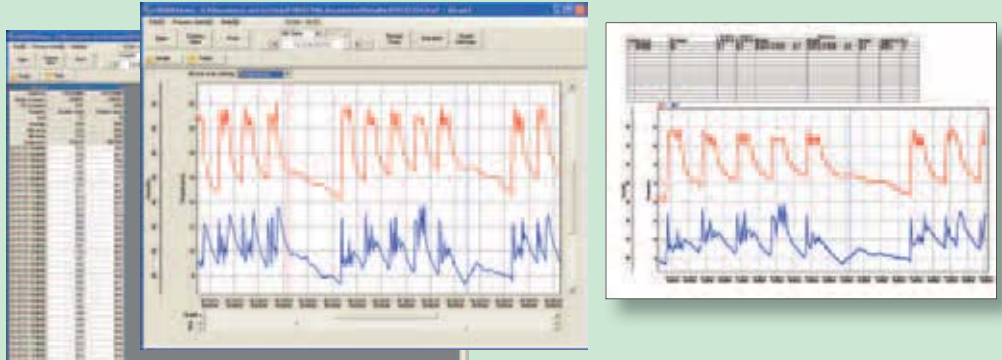

Advanced Features and Functions

Install Almost Anywhere

Easily mount the light-weight, pocket-sized loggers in tight spaces.



Actual size

Easy-to-see dual display

Temperature and humidity or current channels can be displayed. View maximum and minimum values while measuring.

Moist environments

IP54 splash-proof rating withstands operation in extremely humid environments like kitchens and pipe rooms. (Except Model LR5051)



Transfer data even during recording

Continue to record even when transferring data.

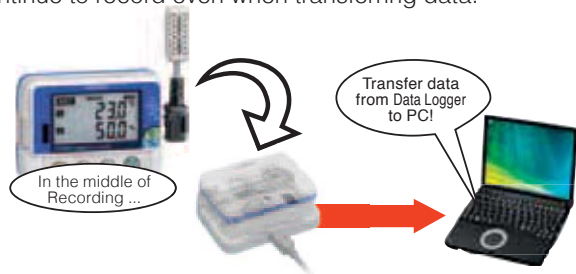

Batteries last up to 2 years

Energy-efficient design provides up to two years of battery life (For the LR5011 only. Actual battery life depends on model type and settings).



Replace batteries while recording

Recording continues for about 30 seconds even with the battery removed.



Note. With the LR5001, recording is interrupted during battery replacement if the battery is very weak. After batteries are replaced, recording resumes automatically. Previously recorded data is not lost during battery replacement.

Recording capacity up to 7 times previous models

Large internal memory stores 60,000 data points per channel. Long-term recording capability exceeds that of previous models.

Interval times	Instantaneous value	Statistical value
1s	16h 40m	-
2s	1d 9h 20m	8h 20m
5s	3d 11h 20m	20h 50m
10s	6d 22h 40m	1d 17h 40m
15s	10d 10h	2d 14h 30m
20s	13d 21h 20m	3d 11h 20m
30s	20d 20h	5d 5h
1m	41d 16h	10d 10h
2m	83d 8h	20d 20h
5m	208d 8h	52d 2h
10m	416d 16h	104d 4h
15m	625d	156d 6h
20m	833d 8h	208d 8h
30m	1250d	312d 12h
60m	2500d	625d

⚠ The maximum recording time depends on battery life. The battery may need to be replaced during long-term recording.

⚠ Customers using the previous Model 3636-20 Clamp Logger should note that the LR5051 can only record 15,000 points of average data, vs. 32,000 data points available in the 3636-20.

Record without missing fluctuations

With usual (instantaneous value) recording at long intervals, detailed fluctuations occurring within the intervals are missed. However, with the statistical value recording mode, detailed fluctuations are captured even when they occur during long recording intervals. In STAT mode, measurement is taken every second, and the maximum, minimum, average, and instantaneous values within the specified interval are recorded.

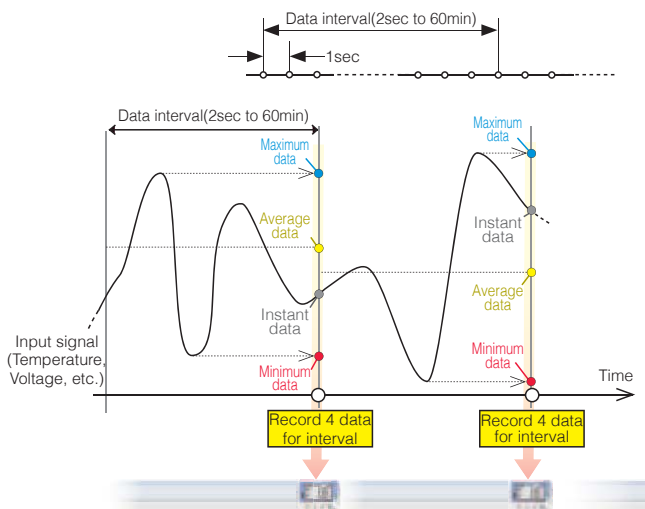

Never worry about a dead battery

The worry-free backup function preserves measurement data even after the battery dies.



Never worry about operating errors

Worry-free backup preserves recorded data even if a new measurement is started by mistake.



Bundled Software Ensures Smooth and Easy Data Analysis

■ Import data to a PC and create graphs

Use the LR5000 Utility program to import Data Logger data to a PC to make graphs and analyze data further. Easily print results using your PC.

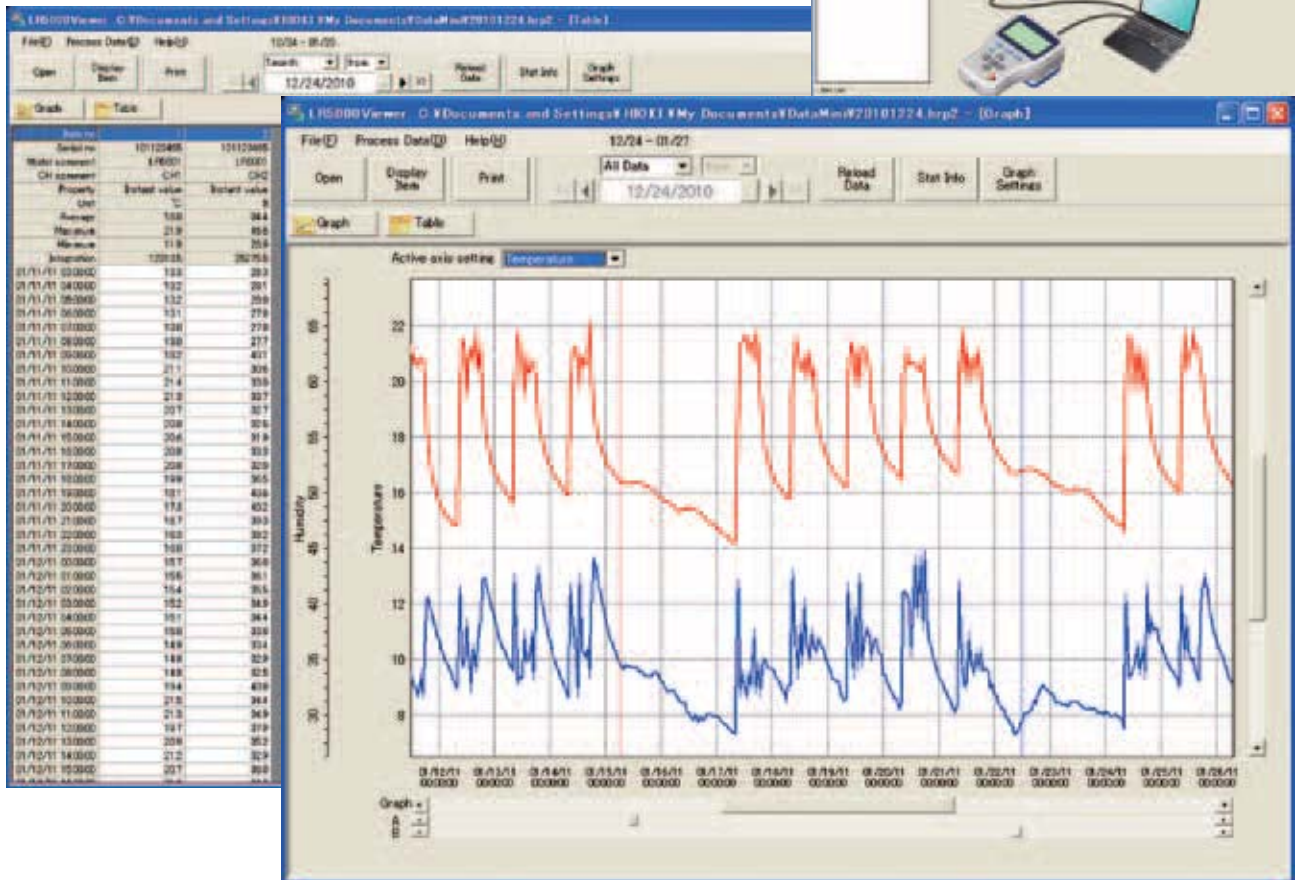

■ Show specific values using the cursor function

Use the A/B cursors to select any location on a graph and display its value. The PC software can also calculate maximum, minimum, and average values between A and B cursors.

■ Simple file aggregation and management

Transferred data can be combined with data previously transferred (from the same Data Logger unit) into one data on the PC.

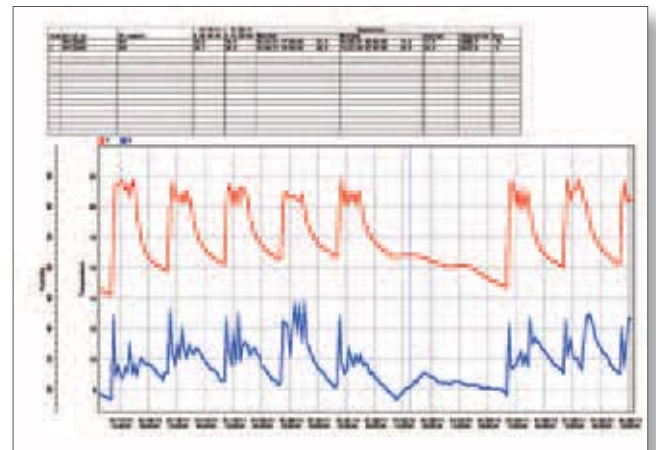
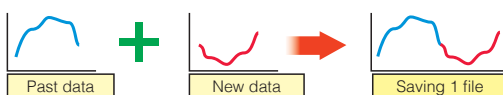

■ Display data from former Data Logger models



The PC application also supports data collected from the HIOKI 36XX Series Data Loggers.



LR5000 Utility Specifications	
Configuring Data Logger	<ul style="list-style-type: none"> • Import/export Data Logger settings (LR5091 or LR5092-20 required) • Settings sent to each LR5000 logger are also saved to the PC.
Graph display	<ul style="list-style-type: none"> • Graphically display data for up to 16 channels • Select colors and display/hide any channel and graph • Copy graph images to clipboard • Display statistical data (maximum, minimum and average) • Scaling function

Print function	Print graphs Print statistical data.
Data processing	Scaling Power calculation Energy cost calculation Operating ratio calculation Integration Dew point temperature Calculate between channels
Operating environment	OS: Windows XP (SP2 or later) Windows Vista (SP1 or later) / Windows 7 CPU : 1GHz or more Memory : 512MB or more Interface : USB Free space in hard disk: 30MB or more

Communication Adapter and Data Collector Specifications (Product guaranteed for one year)

Physical appearance	 CE	 CE SD
Model	Communication Adapter LR5091	Data Collector LR5092-20
Features	<ul style="list-style-type: none"> •Transfer data from a Data logger to a PC •Transfer Data Logger configurations or clock settings from a PC to the Data Logger 	<ul style="list-style-type: none"> •Collect recorded data from the Data Logger to internal memory or SD card •View collected data in a graph •Transfer Data Logger configurations or clock settings from internal memory or SD card to the Data Logger •Transfer data from a Data Logger to a PC •Transfer Data Logger configurations or clock settings from a PC to the Data Logger
Interface with Data Logger	Infrared optical communications	
Interface with PC	USB2.0, Full Speed, Series Mini B Receptacle	
Clock functions	-	Auto calender, auto leap year
Display	-	Dot-matrix LCD (128 × 64 dots)
Display items	-	Data Logger configurations (Interval, Start/Stop method, Recording mode, Scaling, Alarm, Power-saving mode, Clock, Range) Collected data (Record list, Maximum data, Minimum data, Average, Graph, Value)
Internal memory capacity of data	-	60,000 data elements ×16ch (instantaneous value mode) 15,000 data elements ×16ch (statistical value mode)
Removable storage media	-	SD Card (SDHC, Max 32GB) Save data and configurations
Operating environment	Indoors	
Power supply	DC 5 V (USB bus power) Maximum rated power 0.5 VA	DC 3 V (LR6 (AA) Alkaline battery 1.5 V×2) or DC 5 V (USB bus power) Maximum rated power 1 VA
Battery life	-	Approx. 12 hours or 500 times of data collection
Operating temperature and humidity	0°C (32°F) to 40°C (104°F), 80% RH or less (non-condensating)	
Dimensions & Mass	83 mm (3.27 in)W × 61 mm (2.40 in)H × 19mm (0.75 in)D, 43 g (1.5 oz)	91 mm (3.58 in)W × 141 mm (5.55 in)H × 31 mm (1.22 in)D, 215 g (7.6 oz) (excluding batteries)
Accessories	USB cable (1 m)×1, CD (Application software "LR5000 Utility") × 1	Instruction manual ×1, Operation manual×1, LR6 (AA) Alkaline battery 1.5V×2, USB cable (1 m)×1, CD (Application software "LR5000 Utility") × 1

LR5092-20 Option



SD Memory Card (2GB) Z4001

LR5000 Series Common specifications

(Product guaranteed for one year. Accuracy guaranteed for 1 year. Post-adjustment accuracy guaranteed for 1 year)



Recording interval	1/ 2/ 5/ 10/ 15/ 20/ 30 seconds 1/ 2/ 5/ 10/ 15/ 20/ 30/ 60 minutes	Storage capacity	Instantaneous value mode 60,000 data sets per channel Statistical value mode 15,000 data sets per channel <small>Note: Customers using the previous Model 3636-20 Clamp Logger should note that the LR5051 can only record 15,000 points of average data, vs. 32,000 data points available in the 3636-20.</small>
Recording methods	One time recording Stop recording when the memory capacity is full. Endless recording Continue recording even when the memory capacity is full. (old data is overwritten.)	Display items	Measured value, Interval configuration, Date, Time, Alarm, Remaining battery power, Number of data, Maximum data, Minimum data
Recording modes (instantaneous value mode/ statistical value mode)	Instantaneous recording Instantaneous values are recorded at every recording interval. Statistical value recording Measure at one second intervals, and record the instantaneous, maximum, minimum, and average values within every recording interval.	Recording start / stop	Recording start Manual start Timer start Recording stop Manual stop Timer stop When the memory capacity is full (One time recording)
		Data backup	Data from the last recording session is always backed up. Back up recorded data and configuration when battery is dead.
		Interface	Infrared optical communications with LR5091, LR5092-20
		Power supply	During battery replacement, recording and clock operations are preserved for about 30 seconds. (Recording operation continues if the battery is replaced within about 30 seconds.) <small>Note: With the LR5001, recording is interrupted during battery replacement if the battery is very weak. After batteries are replaced, recording resumes automatically. Previously recorded data is not lost during battery replacement.</small>

LR5000 Series common options







Magnetic Strap
Z5004



Wall-mounted Holder
LR9901
Not compatible with Model LR5051

Analysis of measurement data on a PC requires the optional LR5091 Communication Adapter or LR5092-20 Data Collector. See page 6 for details.

Product Specifications (Product guaranteed for 1 year, Accuracy guaranteed for 1 year, Post-adjustment accuracy guaranteed for 1 year) See page 6 for Common specifications

Physical appearance	 	 																																																
Model	HUMIDITY LOGGER LR5001	TEMPERATURE LOGGER LR5011																																																
Features	Temperature and humidity are recorded simultaneously using supplied or optional temperature and humidity sensors.	Temperature measurement with external temperature sensor. Select the sensor according to the measurement object																																																
Measurement items	Temperature 1ch and Humidity 1ch	Temperature 1ch																																																
Measurement range	Temperature : -40°C to 85°C Humidity : 0% to 100% RH	-40.0°C to 180°C *Depends on measurement range of sensor.																																																
Accuracy	<table border="1"> <tr><th colspan="2">Temperature (LR5001 + Sensor)</th></tr> <tr><td>85</td><td>±2.0°C</td></tr> <tr><td>70</td><td>±1.0°C</td></tr> <tr><td>35</td><td>±0.5°C</td></tr> <tr><td>0</td><td>±1.0°C</td></tr> <tr><td>-40</td><td>±1.0°C</td></tr> </table> <table border="1"> <tr><th colspan="2">Humidity (LR5001+Sensor)</th></tr> <tr><td>10</td><td>±10%RH</td></tr> <tr><td>20</td><td>±8%RH</td></tr> <tr><td>30</td><td>±6%RH</td></tr> <tr><td>40</td><td>±8%RH</td></tr> <tr><td>50</td><td>±6%RH</td></tr> <tr><td>60</td><td>±5%RH</td></tr> <tr><td>70</td><td>±6%RH</td></tr> <tr><td>80</td><td>±8%RH</td></tr> <tr><td>90</td><td>±10%RH</td></tr> <tr><td>100</td><td>±15%RH</td></tr> </table> <p>* Values provided for reference only.</p>	Temperature (LR5001 + Sensor)		85	±2.0°C	70	±1.0°C	35	±0.5°C	0	±1.0°C	-40	±1.0°C	Humidity (LR5001+Sensor)		10	±10%RH	20	±8%RH	30	±6%RH	40	±8%RH	50	±6%RH	60	±5%RH	70	±6%RH	80	±8%RH	90	±10%RH	100	±15%RH	<table border="1"> <tr><th colspan="2">Temperature : °C (LR5011+Sensor)</th></tr> <tr><td>180</td><td>±5.0°C</td></tr> <tr><td>120</td><td>±2.0°C</td></tr> <tr><td>70</td><td>±1.0°C</td></tr> <tr><td>35</td><td>±0.5°C</td></tr> <tr><td>0</td><td>±1.0°C</td></tr> <tr><td>-40</td><td>±1.0°C</td></tr> </table>	Temperature : °C (LR5011+Sensor)		180	±5.0°C	120	±2.0°C	70	±1.0°C	35	±0.5°C	0	±1.0°C	-40	±1.0°C
Temperature (LR5001 + Sensor)																																																		
85	±2.0°C																																																	
70	±1.0°C																																																	
35	±0.5°C																																																	
0	±1.0°C																																																	
-40	±1.0°C																																																	
Humidity (LR5001+Sensor)																																																		
10	±10%RH																																																	
20	±8%RH																																																	
30	±6%RH																																																	
40	±8%RH																																																	
50	±6%RH																																																	
60	±5%RH																																																	
70	±6%RH																																																	
80	±8%RH																																																	
90	±10%RH																																																	
100	±15%RH																																																	
Temperature : °C (LR5011+Sensor)																																																		
180	±5.0°C																																																	
120	±2.0°C																																																	
70	±1.0°C																																																	
35	±0.5°C																																																	
0	±1.0°C																																																	
-40	±1.0°C																																																	
Waterproof and dust-proof performance	IP54 (splash-proof construction)																																																	
Operating temperature and humidity	-20°C (-4°F) to 70°C (158°F) , 80% RH or less (non-condensating)																																																	
Dimensions & mass	Approx. 79 mm (3.11 in)W × 57 mm (2.24 in)H × 28 mm (1.10 in)D 105 g (3.7 oz)																																																	
Power supply	LR6 (AA) Alkaline battery 1.5 V×1																																																	
Accessories	Humidity sensor LR9504×1, Kickstand	Kickstand																																																
	LR6 (AA) Alkaline battery 1.5 V×1, Instruction manual ×1, Operation manual×1																																																	
Battery life	Case 1 : Approx. 3 months Case 2: Approx. 20 days	Case 1 : Approx. 2 years Case 2: Approx. 2 months																																																
	Case 1 : 1min. recording interval, power-saving mode, Instantaneous recording, environmental temp.20°C Case 2 : 1sec. recording interval, power-saving mode, Instantaneous recording, environmental temp.20°C																																																	

(Reference) When the recording interval is set to 10 minutes, the LR5001 Temperature and Humidity Logger can measure for about one year between battery replacements.

LR5001 Options Humidity Sensor

■ Humidity Sensor

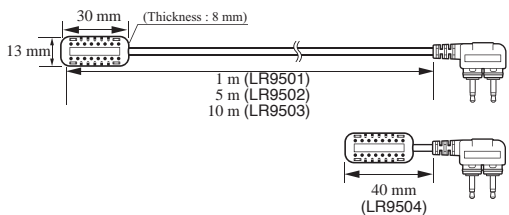

- Models (length) : LR9501 (1 m) LR9502 (5 m) LR9503 (10 m) LR9504 (40 mm, bundled accessory)
- Temperature range : -40.0°C to 85.0°C
- Humidity range : 0.0% to 100.0% RH
- Response time : Approximately 300 seconds (Temperature and humidity; 90% response time)

LR5011 Options Temperature Sensor

■ Molded plastic type

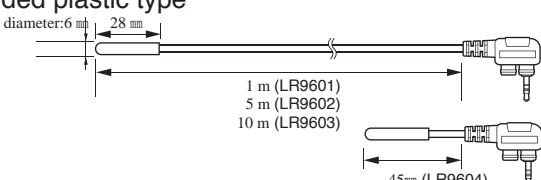

- Models (length) : LR9601 (1 m) LR9602 (5 m) LR9603 (10 m) LR9604 (45 mm)
- Temperature range : -40°C to 180°C
- Response time : Approx. 100 seconds (90% response time)
- Material : Cable : Silicon Sensor head : Silicon

■ Lug type

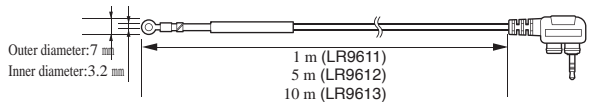

- Models(length) : LR9611 (1 m) LR9612 (5 m) LR9613 (10 m)
- Temperature range : -30°C to 180°C
- Response time : Approx. 45 seconds (90% response time)
- Material: Cable : Silicon Sensor head : Nickel-plated brass

■ Sheathed type

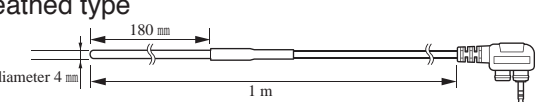

- Models(length) : LR9621(1 m)
- Temperature range : -40°C to 120°C
- Response time : Approx. 90 seconds (90% response time)
- Material : Cable : Silicon Sensor head : SUS304



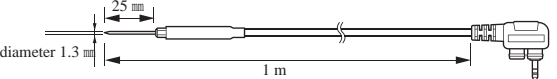

■ Needle type



- Models(length) : LR9631(1 m)
- Temperature range : -40°C to 120°C
- Response time : Approx. 20 seconds (90% response time)
- Material : Cable : Silicon Sensor head : SUS304

Analysis of measurement data on a PC requires the optional LR5091 Communication Adapter or LR5092-20 Data Collector. See page 6 for details.

Product Specifications (Product guaranteed for 1 year, Accuracy guaranteed for 1 year, Post-adjustment accuracy guaranteed for 1 year) See page 6 for Common specifications

Physical appearance	 	 
Model	INSTRUMENTATION LOGGER LR5031	VOLTAGE LOGGER LR5041, LR5042, LR5043
Features	For recording 4-20 mA instrumentation signals, etc.	For recording instrumentation signals and measuring analog outputs from sensors and other devices
Measurement items	For Instrumentation / 0 to 20 mA DC, 1ch	DC voltage 1ch
Measurement range	DC -30.00 to 30.00 mA	LR5041: -50.00 mV to 50.00 mV LR5042: -5.000 V to 5.000 V LR5043: -50.00 V to 50.00 V
Accuracy	±0.5% rdg. ±5 dgt. (@23°C ±5°C)	±0.5% rdg. ±5 dgt. (@23°C ±5°C)
Waterproof and dust-proof performance	IP54 (splash-proof construction)	
Operating temperature and humidity	-20°C(-4°F) to 70°C(158°F) , 80% RH or less (non-condensating)	
Dimensions & Mass	Approx. 79 mm (3.11 in)W × 57 mm (2.24 in)H × 28 mm (1.10 in)D, 105 g (3.7 oz)	
Power supply	LR6 (AA) Alkaline battery 1.5 V×1	
Accessories	Connection Cable LR9801×1, Kickstand	Connection Cable LR9802×1, Kickstand
	LR6 (AA) Alkaline battery 1.5 V×1, Instruction manual×1, Operation manual×1	
Battery life	Case 1 : Approx. 2 years Case 2: Approx. 2 months Case 1 : 1min. recording interval, power-saving mode, Instantaneous recording, environmental temp.20°C Case 2 : 1 sec. recording interval, power-saving mode, Instantaneous recording, environmental temp.20°C	
Other	-	Preheat function (When using preheat function, a separate external power supply is required.)

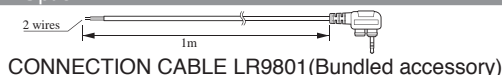

LR5031 Option



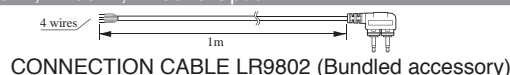









LR5041, LR5042, LR5043 Option

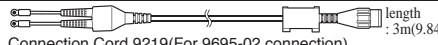

Product Specifications (Product guaranteed for 1 year, Accuracy guaranteed for 1 year, Post-adjustment accuracy guaranteed for 1 year) See page 6 for Common specifications

Physical appearance	  *Sensor is sold separately. *For customers using the previous Model 3636-20 Clamp Logger, please note the difference in recordable average data points available in the LR5051. (Please refer to page 4.)
Model	CLAMP LOGGER LR5051
Features	Recording load current of 50Hz/60Hz Recording leak current *Current and leak current that occur intermittently cannot be measured. The Clamp Logger LR5051 may be affected by high-frequency noise during leak current measurement. Please contact Hioki for more information if you plan to use the instrument in an environment where it would be affected by such noise.
Measurement items	AC Current (2 channels)
Measurement range	When Using 9669 : 1000 A range When Using CT6500 : 50.00 A / 500.0 A range When Using 9695-02 : 5.000 A / 50.00 A range When Using 9675 : 500.0 mA / 5.000 A range When Using 9657-10 : 500.0 mA / 5.000 A range
Accuracy	±0.5% rdg. ±5dgt. + Clamp sensor accuracy
Waterproof and dust-proof performance	Not waterproof
Operating temperature and humidity	-0°C (32°F) to 50°C (122°F) , 80% RH or less (non-condensating)
Dimensions & mass	Approx. 79 mm (3.11 in)W × 70 mm (2.76 in)H × 37 mm (1.46 in)D, 165 g(5.8 oz)
Power supply	LR6 (AA) Alkaline battery 1.5V × 2
Accessories	LR6 (AA) Alkaline battery 1.5V × 2 Instruction manual ×1, Operation manual×1
Battery life	Case 1 : Approx. 1 years Case 2: Approx. 1 months Case 1 : 1min. recording interval, power-saving mode, Instantaneous recording, environmental temp.20°C Case 2 : 1 sec. recording interval, power-saving mode, Instantaneous recording, environmental temp.20°C

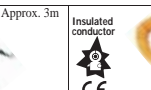
LR5051 Options

Load current	Cord length : Approx. 3m	Cord length : Approx. 3m	Connection cord 9219 is required (sold separately)
Physical appearance	 	 	 
Model	CLAMP ON SENSOR 9669	CLAMP ON SENSOR CT6500	CLAMP ON SENSOR 9695-02
Measurable conductor diameter	φ55 mm (2.17") or less, 80 (3.15") × 20 (0.79") mm busbar	φ46 mm (1.81") or less	φ15 mm (0.59") or less
Primary current rating	1000 A AC	500 A AC	50 A AC
Accuracy (45Hz to 66Hz)	±1.0% rdg. ±0.01% f.s.	±1.5% rdg. ±0.03% f.s.	±0.3% rdg. ±0.02% f.s.
Maximum rated voltage to earth	CAT III 600 V rms	CAT III 600 V rms	CAT III 300 V rms
Maximum allowable input (45 to 66 Hz)	1000 A continuous	600 A continuous	60 A continuous
Dimensions & mass	99.5 (3.92")W × 188 (7.40")H × 42 (1.65")D mm, 590 g (20.8 oz.)	77 (3.03")W × 151 (5.94")H × 42 (1.65")D mm, 360 g (12.7 oz.)	51 (2.01")W × 58 (2.28")H × 19 (0.75")D mm, 50 g (1.8 oz.)
	 Connection Cord 9219 (For 9695-02 connection)		
Load current	Cord length : Approx. 3m	Cord length : Approx. 3m	
Physical appearance	 	 	
Model	CLAMP ON LEAK SENSOR 9675	CLAMP ON LEAK SENSOR 9657-10	
Measurable conductor diameter	φ30 mm	φ40 mm	
Primary current rating	5 A AC (Using with LR5051)	5 A AC (Using with LR5051)	
Accuracy (45Hz to 66Hz)	±1.0% rdg. ±0.005% f.s.	±1.0% rdg. ±0.05% f.s.	
Lag current	1 mA (When 10 A AC is input)	5 mA (When 100 A AC is input)	
Measurable conductor	Insulated conductor	Insulated conductor	
Maximum allowable input (45 to 66 Hz)	10A continuous	30A continuous	
Dimensions & mass	60 (2.36")W × 113 (4.45")H × 24 (0.94")D mm, 160g (5.6 oz.)	74 (2.91")W × 145 (5.71")H × 42 (1.65")D mm, 380g (13.4 oz.)	

Note: Company names and Product names appearing in this catalog are trademarks or registered trademarks of various companies.

HIOKI
HIOKI E. E. CORPORATION

TECNOLOGIA

HIOKI

Le tecnologie di misura Hioki sono ampiamente e globalmente utilizzate per manutenzione, controllo qualità, ricerca e sviluppo, in ambito industriale, aziendale e delle infrastrutture, contribuendo alla sicurezza ed alla protezione del nostro vivere quotidiano.

L'azienda supporta inoltre lo sviluppo delle tecnologie di nuova generazione nei settori automotive ed energie rinnovabili, favorendo la diffusione di prodotti di elevata qualità a prezzi competitivi.

La mission di Hioki è di produrre e divulgare tecnologie di misura volte a proteggere la sicurezza delle persone e consentire, attraverso il supporto alla ricerca, il progresso della scienza e della tecnica.



I numeri:

10% del fatturato investito in R&S

250 ingegneri impiegati nella ricerca

30 nuovi prodotti all'anno

100 brevetti depositati all'anno

1200 prodotti a catalogo

800.000 pezzi venduti all'anno

50 ppm (pezzi per milione) indice di difettosità

10.000 prove di apertura e chiusura per testare la durata dei toroidi

1 metro di caduta per testare la resistenza degli strumenti

Made in Japan



asita
TECNOLOGIE DI MISURA



s.r.l

Via Malpighi, 170
48018 Faenza (RA) - Italy
www.asita.com
asita@asita.com
+39 0546 620559
P.IVA 00202980397