



Manage Electrode Reaction Resistance, Electrolyte Resistance, and Welding Resistance

The Ultimate Instrument for Measuring Large-Capacity Li-ion Batteries for EVs



Improve the quality of battery cell inspections

- Set your own measurement frequency between 100 mHz and 1.05 kHz
- Use low frequencies to measure **electrode reaction resistance**
- Use high frequencies to measure **electrolyte resistance and welding resistance**
- Create Cole-Cole plots (with bundled application program)
- Use equivalent circuit analytic software to analyze internal battery defects



Use the BT4560 for impedance measurement... To isolate defective factors in battery cells

Conceptual diagram of a battery

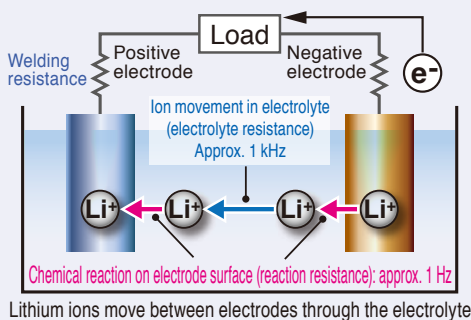

Battery equivalence circuit

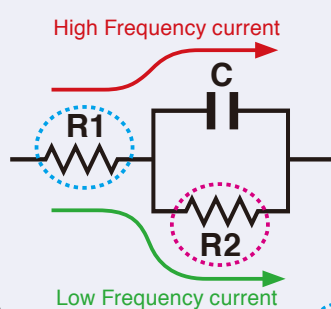

Cole-Cole plot

Inspect both electrolyte and reaction resistance

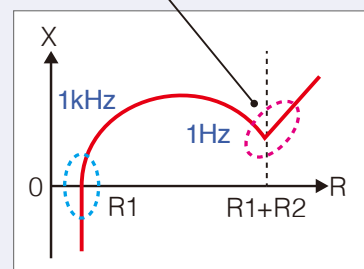

Electrolyte resistance and welding resistance

Reaction resistance

When R1 is larger... Electrolyte concentration might be reduced, or the electrode might have poor welding

When R2 is larger... A failure might have occurred during the electrode production process, or the electrode might react poorly on its surface

DC-IR measurement using a charging/discharging tester

DC-IR measurement passes electric currents into R1 and R2, which makes it difficult to measure electrolyte resistance and reaction resistance separately. (See the equivalent circuit diagram shown above)

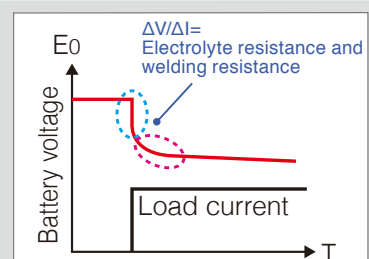

Exceptional Accuracy Unsurpassed Stability

Also measure large-capacity
Li-ion batteries

Measure very low impedances of 1mΩ or less

Some high-capacity Li-ion batteries have an internal impedance less than 1 mΩ.
The BT4560 can measure very low impedances of 1mΩ or less, stably and with high reproducibility.

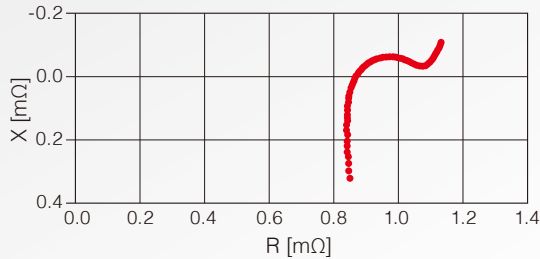

Measure DC voltage with high accuracy

Accuracy: $\pm 0.0035\%$ rdg. ± 5 dgt.

The BT4560 achieves an accuracy comparable to a 6.5-digit DMM. It can be used to measure both OCV and impedance in batteries.

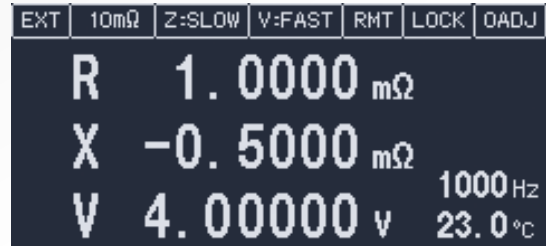

Measure 4-V Li-ion battery cells at an accuracy of $\pm 190 \mu\text{V}$

Four-terminal pair measurement resolves system construction problems

The four-terminal pair method reduces various effects of induced magnetic fields, such as cabling influence, eddy-current influence due to surrounding metals, and interference when multiple devices are used simultaneously. When compared to the conventional four-terminal method, the BT4560 controls magnetic fluxes generated by the measurement current. This significantly reduces the impact on the measured value when cabling is changed, improving stability when the measurement instrument is embedded within the production line.

Magnetic flux influence using the conventional four-terminal method

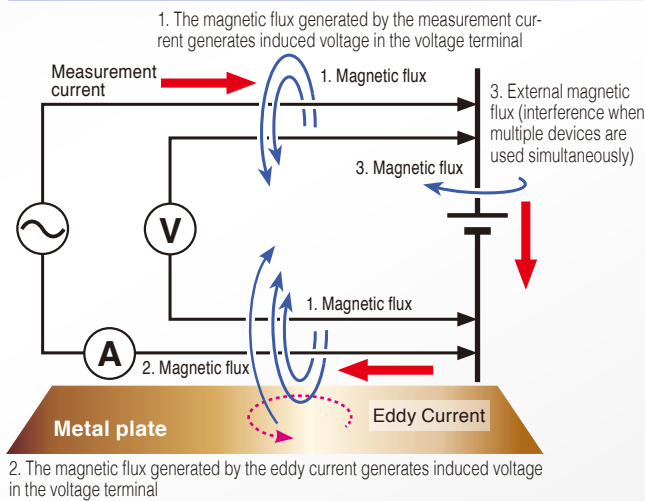

Impedance measurement using the four-terminal pair method

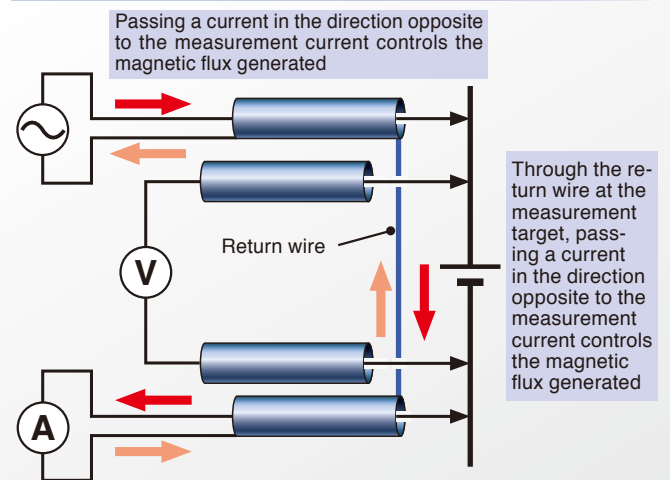

Dedicated probes for four-terminal pair measurement reduce the magnetic flux generated

Dedicated probes with the four-terminal pair structure provide stable measurement less affected by environmental noise or cabling.

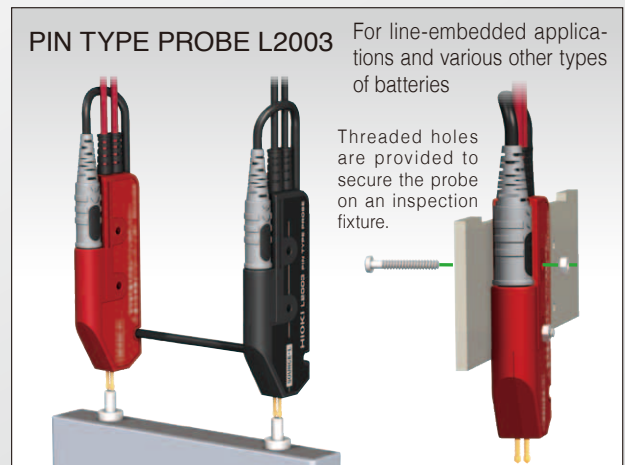
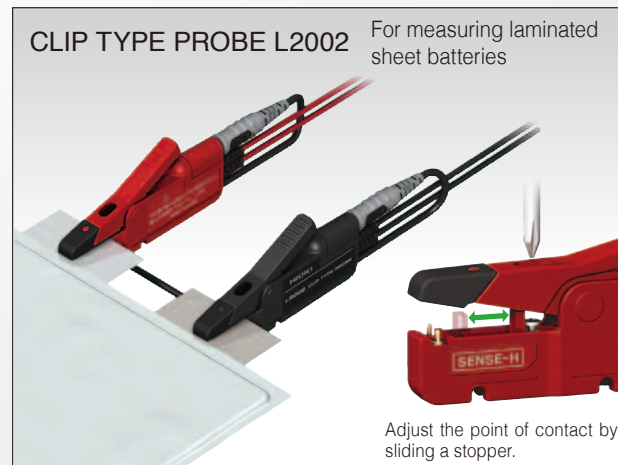

* Contact your local Hioki distributor for details of the probe tip shapes

Using impedance data measured with the

Battery cell selection extends the battery pack service life

Battery pack deterioration factors

Heat reduces or deteriorates the battery capacity. Large-capacity batteries for EVs that charge/discharge with large currents generate significant amounts of heat.

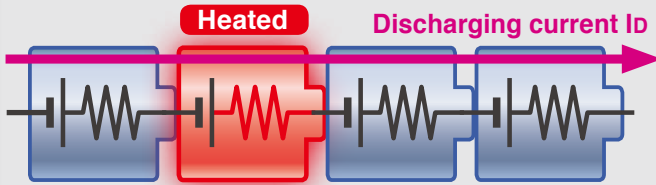

If the resistance of the battery pack is different, some of the batteries will heat up excessively, thereby lowering the capacity and accelerating deterioration.

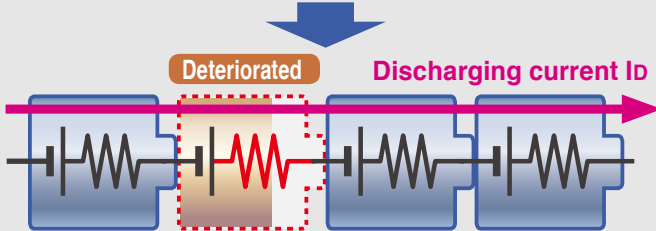

The protective circuit works based on the cell with the lowest capacity, reducing the discharging capacity of the entire battery pack as a result.

Selection is necessary for extending battery pack service life

Combining cells with the same battery capacity and internal resistance equalizes heat generated, extending the service life.

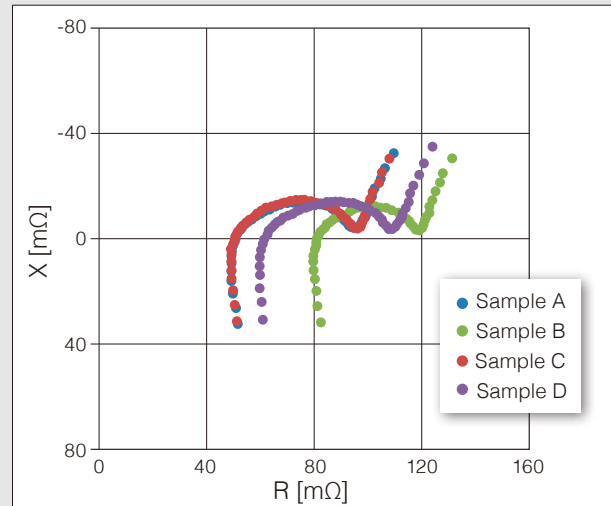

The above diagram contains Cole-Cole plots for new battery cells of the same kind. A and C have almost consistent impedance characteristics.

Due to having impedance greater than A and C, B and D produce heat and deteriorate first when they are used within the same battery pack.

Checking the battery deterioration level

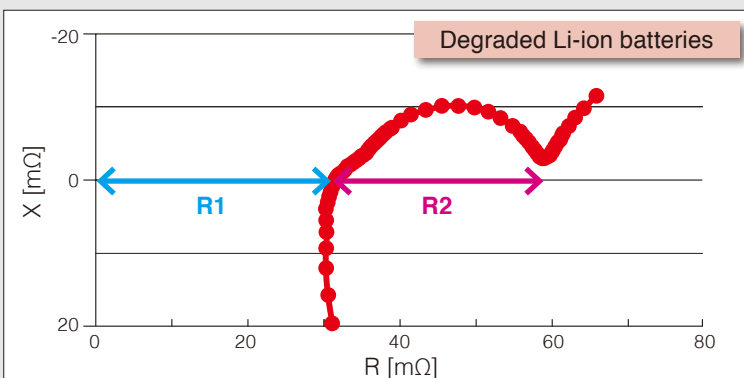
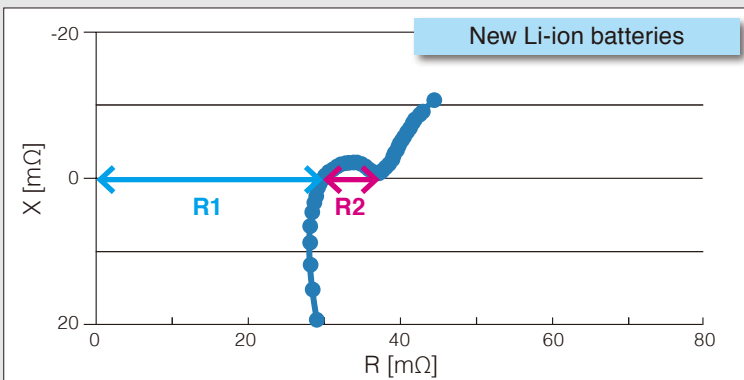

Compare measured data for new and deteriorated batteries

Here, Cole-Cole plot data is compared for new Li-ion battery cells (upper-left plot) and deteriorated Li-ion battery cells of the same kind (lower-left plot).

R1: Electrolyte resistance and welding resistance

R2: Reaction resistance
(Reaction resistance of positive/negative electrodes)

Comparing the new Li-ion battery with the deteriorated one confirms significant changes in the reaction resistance value.

Although much depends on the deterioration factors, in addition to heat effects, the deterioration of the electrode reactive portion appears on a graph as reaction resistance for particular applications, such as repeated charging/discharging at low temperature and repeated deep charging/discharging (SOC: Between 0 and 100%).

Isolate battery deterioration factors

Cole-Cole plot data obtained by using the BT4560 and commercially-available equivalent circuit analysis software, such as "ZView[®]", can be used to analyze deterioration factors.

An example of a pseudo-equivalent circuit

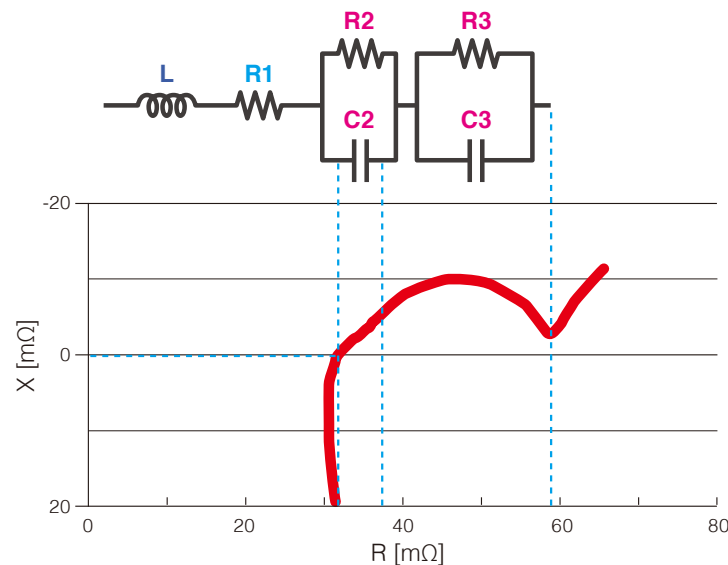

The impedance characteristics of a Cole-Cole plot are generally expressed as a pseudo equivalent circuit.

A pseudo equivalent circuit is expressed by:

Resistance in the electrolyte and tab welding portions (R1)

Positive/negative electrode reactions within the battery (R2//C2, R3//C3)

Lead and other inductance (L)

... to give just a few examples.

Once a pseudo equivalent circuit is constructed, equivalent circuit analysis software (ZView[®]) can provide the circuit constant of each element by means of curve fitting. Quantifying the changes in each element's constant when a battery is new and when it deteriorates allows analysis of which portions within the battery have changed. This serves to isolate battery deterioration factors.

Create Cole-Cole plots using bundled software

A free PC application that comes with the BT4560 can conduct measurement and draw Cole-Cole plots. Additionally, "ZView[®]" from Scribner Associates Inc. also provides detailed analysis based on equivalent circuit analysis.

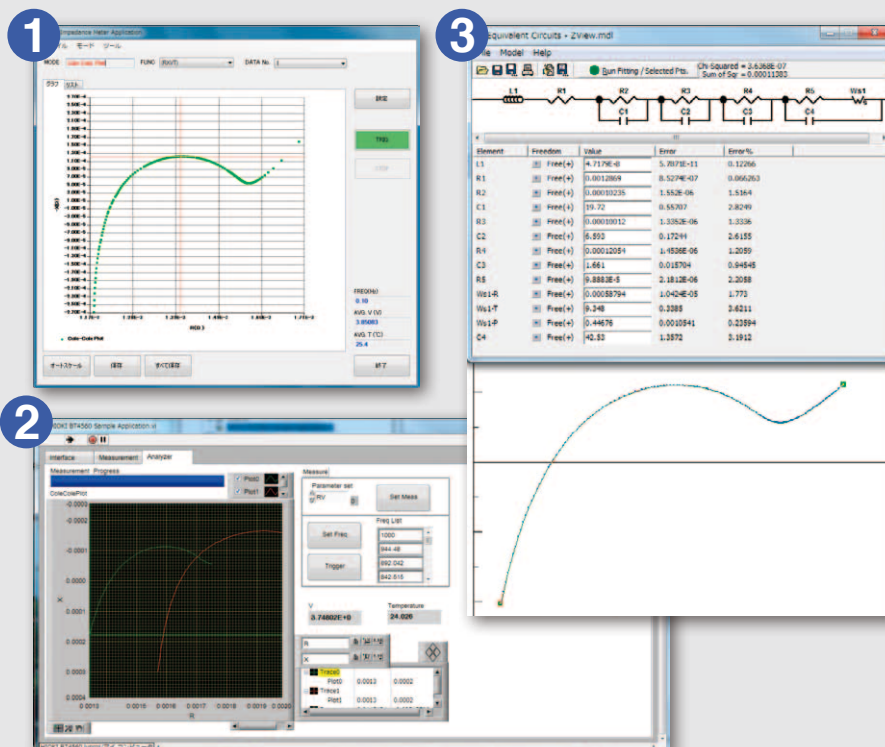

1 Bundled PC application

Creates Cole-Cole plots. Measurement results can also be output in Excel and CSV files.

2 Application bundled with LabView driver

Compares multiple overlaid graphs. Equipped with a simple equivalent circuit analysis function, this application also gives insight into electrolyte resistance and reaction resistance.

3 AC impedance analysis software "ZView[®]"

"ZView[®]" creates certain equivalent circuits based on CSV files output from the above application 1, while quantifying each element, to analyze deteriorated portions in a battery.

Characteristics and features of BT4560

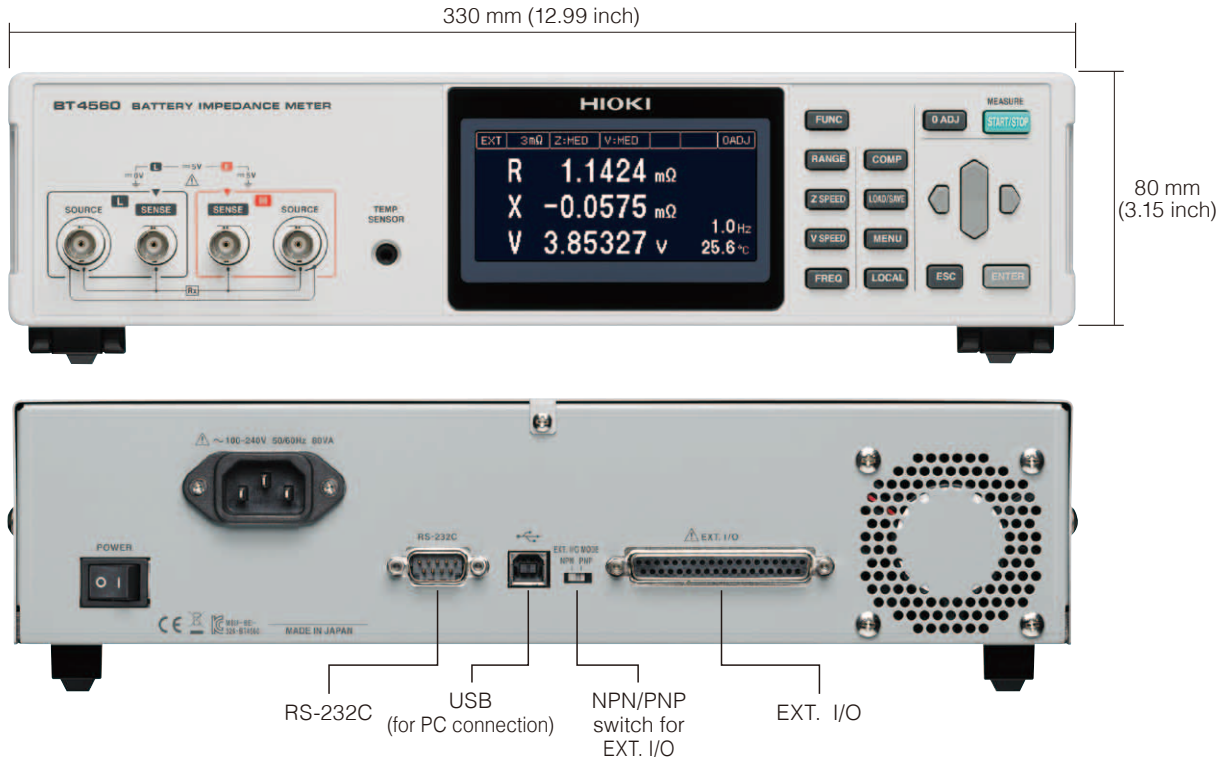

All-in-one compact unit

The BT4560 requires no loading devices and provides measurements simply as a stand-alone unit, without having to establish a complicated measurement system.

Self-calibration

Correct any offset voltage and gain drift that may be present in the circuit to improve the accuracy of voltage measurement.

Sample delay*

Specify a delay between AC voltage being applied and sampling being started so that measurement can start after the response stabilizes.

Prevent charging or discharging when AC voltage is applied*

To prevent the battery that is being measured from charging or discharging, the battery impedance meter terminates the applied measurement signal when zero is crossed.

Simultaneous measurement of impedance and voltage

Reduce tact time by testing both impedance and high accuracy DC voltage at the same time.

Slope correction function*

If measurement signals drift due to the battery characteristics or the input impedance of measurement instrument, the BT4560 applies correction to the linear drift.

Temperature measurement

Reaction resistance measured at low frequency is sensitive to temperature.

An optional temperature sensor measures the temperature around the battery and associates the results with data, thereby improving the reliability of the measurements.

*Functions available during impedance measurement

Functions to accommodate automated machines

Contact check

Monitor the contact resistance of the probe before and after measurement so that the measurement will only start when the measuring electrode on the probe is in contact with the object to be measured.



Comparator

- Simultaneously measure impedance and voltage
- Output overall determination results
- Use the two-tone buzzer to indicate determination results

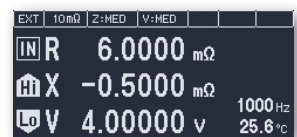

NPN/PNP switch

Switch the input/output circuits for EXT. I/O according to the type of output: current sink output (NPN) or current source output (PNP).

Panel saving and loading

Store up to 126 sets of measurement conditions in internal memory so that they can be called through EXT. I/O for future measurements.

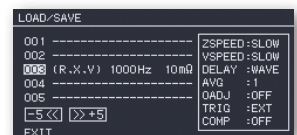

Accuracy specifications

Impedance measurement accuracy

○ 3 mΩ range (0.1 Hz to 100 Hz), 10 mΩ range, 100 mΩ range

$$R \text{ accuracy} = \pm (0.004 |R| + 0.0017 |X|) [\text{m}\Omega] \pm \alpha$$

$$X \text{ accuracy} = \pm (0.004 |X| + 0.0017 |R|) [\text{m}\Omega] \pm \alpha$$

(The units of R and X are [mΩ]. α is as shown in the table below.)

$$Z \text{ accuracy} = \pm 0.4\% \text{ rdg.} \pm \alpha (|\sin\theta| + |\cos\theta|)$$

$$\theta \text{ accuracy} = \pm 0.1^\circ \pm 57.3 \frac{\alpha}{Z} (|\sin\theta| + |\cos\theta|)$$

(α is as shown in the table below.)

α	3 mΩ range			10 mΩ range			100 mΩ range			
	FAST	25 dgt.			60 dgt.			60 dgt.		
	MED	15 dgt.			30 dgt.			30 dgt.		
	SLOW	8 dgt.			15 dgt.			15 dgt.		
Temperature coefficient		R: ± R accuracy × 0.1 / °C, X: ± X accuracy × 0.1 / °C, Z: ± Z accuracy × 0.1 / °C, θ: ± θ accuracy × 0.1 / °C, (Applied in the ranges of 0 °C to 18°C and 28°C to 40 °C)								

○ 3 mΩ range (110 Hz to 1050 Hz)

$$R \text{ accuracy} = \pm (0.004 |R| + 0.0052 |X|) [\text{m}\Omega] \pm \alpha$$

$$X \text{ accuracy} = \pm (0.004 |X| + 0.0052 |R|) [\text{m}\Omega] \pm \alpha$$

(The units of R and X are [mΩ]. α is as shown in the table below.)

$$Z \text{ accuracy} = \pm 0.4\% \text{ rdg.} \pm \alpha (|\sin\theta| + |\cos\theta|)$$

$$\theta \text{ accuracy} = \pm 0.3^\circ \pm 57.3 \frac{\alpha}{Z} (|\sin\theta| + |\cos\theta|)$$

(α is as shown in the table below.)

Accuracy graph

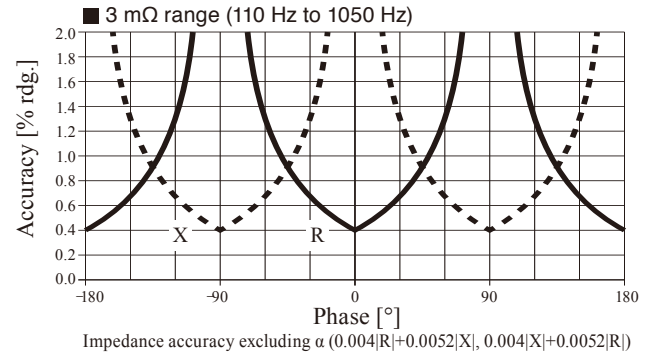
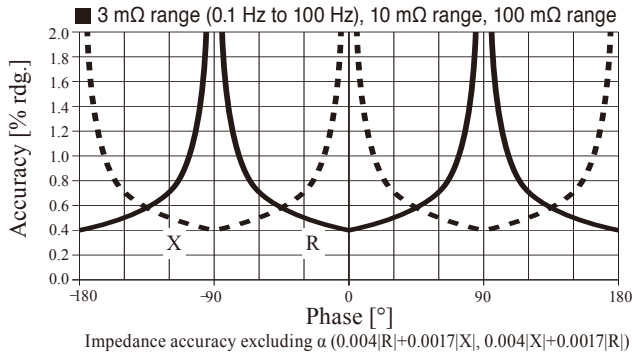

Voltage measurement accuracy (when self-calibration is performed)

V	Display range	-5.10000 V to 5.10000 V
	Resolution	10 μV
Voltage accuracy	FAST	±0.0035% rdg. ±5 dgt.
	MED	±0.0035% rdg. ±5 dgt.
	SLOW	±0.0035% rdg. ±5 dgt.
Temperature coefficient	±0.0005% rdg. ±1 dgt. /°C (applied in the ranges of 0°C to 18°C and 28°C to 40°C)	

Temperature measurement accuracy (BT4560 + Z2005 temperature sensor)

Accuracy	±0.5°C (measurement temperature: 10.0°C to 40.0°C) ±1.0°C (measurement temperature: -10.0°C to 9.9°C, 40.1°C to 60.0°C)
Temperature coefficient	Temperature coefficient: ±0.01°C/°C (applied in the ranges of 0°C to 18°C and 28°C to 40°C)

BT4560 specifications (Accuracy guaranteed for 1 year, Post-adjustment accuracy guaranteed for 1 year)

Measured signals	Impedance, voltage, temperature			Measurement functions	(R,X,V,T)/(Z,θ,V,T)/(R,X,T)/(Z,θ,T)/(V,T)
Impedance measurement				Function	Comparator, self-calibration, sample delay, average, voltage limit, potential gradient compensation for impedance measurement, charge/discharge prevention during AC signal application, key lock, system test, panel saving and loading (up to 126 condition sets)
Measurement parameters	R resistance, X reactance, Z impedance, θ phase angle			Measurement error detection	Contact check, measurement current error, voltage drift on measured object, overvoltage input, voltage limit
Measurement frequency	0.1 Hz to 1050 Hz			Interface	RS-232C/USB (virtual COM port) * Cannot be used simultaneously Transmission speed: 9,600 bps/19,200 bps/38,400 bps
Frequency setting resolution	0.10 Hz to 0.99 Hz in 0.01-Hz increments 1.0 Hz to 9.9 Hz in 0.1-Hz increments 10 Hz to 99 Hz in 1-Hz increments 100 Hz to 1050 Hz in 10-Hz increments			EXT. I/O	TRIG, LOAD, Hi, IN, Lo, and others (NPN/PNP can be switched)
Measurement ranges	3.0000 mΩ, 10.0000 mΩ, 100.000 mΩ			Allowable input voltage	Up to 5 V
Measurement current/DC load (DC load: offset current applied to measured object during impedance measurement)				Operating temperature and humidity range	0°C to 40°C, 80% RH or less (no condensation)
	3 mΩ range	10 mΩ range	100 mΩ range	Storage temperature and humidity range	-10°C to 50°C, 80% RH or less (no condensation)
Measurement current	1.5 Arms ±10%	500 mArms ±10%	50 mArms ±10%	Operating environment	Indoor, pollution degree 2, altitude up to 2,000 m
DC load current	1 mA or less	0.35 mA or less	0.035 mA or less	Power supplies	Rated supply voltage: 100 to 240 VAC Rated supply frequency: 50/60 Hz
Measurement wave number				Rated power	80 VA
	FAST	MED	SLOW	Dielectric strength	1.62 kVAC, 1 min, cutoff current 10 mA (Between power supply terminal lump and protective ground)
0.10 Hz to 66 Hz	1 wave	2 waves	8 waves	Applicable standards	Safety: EN61010 EMC: EN61326, EN61000-3-2, EN61000-3-3
67 Hz to 250 Hz	2 waves	8 waves	32 waves	Dimensions and mass	Approx. 330W × 80H × 293D mm (12.99W × 3.15H × 11.54D in), Approx. 3.7 kg (130.5 oz)
260 Hz to 1050 Hz	8 waves	32 waves	128 waves	Accessories	Power cord ×1, instruction manual ×1, zero-adjustment board ×1, USB cable (A-B type) ×1, CD-R (communication instruction manual, PC application software, USB driver) ×1
Voltage measurement					
Measurement range	5.00000 V (single range)				
Resolution	10 μV				
Measurement time	FAST : 0.1 s MED : 0.4 s SLOW : 1.0 s			* When self-calibration is performed, 0.21s is added to the measurement time.	
Temperature measurement					
Display range	-10.0°C to 60.0°C				
Resolution	0.1°C				
Measurement time	2.3 s				

Instrument



Model : BATTERY IMPEDANCE METER BT4560

Model No. (Order Code) (Note)

BT4560

Note: This product is not supplied with measurement probes. Please select and purchase the measurement probe options appropriate for your application separately.

Options

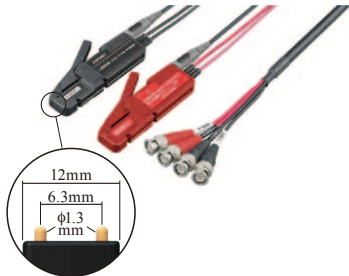

CLIP TYPE PROBE L2002
Cable length 1.5 m (4.92 ft)

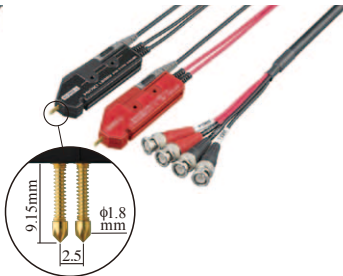

PIN TYPE PROBE L2003
Cable length 1.5 m (4.92 ft)



TEMPERATURE SENSOR Z2005
Cable length 1 m (3.28 ft)



RS-232C CABLE 9637
For the PC, 9 pins - 9 pins, cross,
Cable length 1.8 m (5.91 ft)

Custom specification line-up			Measurement frequency	
			Standard 0.10 Hz to 1050 Hz	Custom 0.01 Hz to 1050 Hz
Measurement voltage	Standard	5 V (±5.10000 V) Measuring range: 3mΩ/10 mΩ/100 mΩ Measurement current: 1.5 A/500 mA/50 mA	Standard specification	Custom specifications 1
	Custom	10 V (±9.99999 V) Measuring range: 30 mΩ/300 mΩ Measurement current: 500 mA/50 mA	Custom specifications 2	Custom specifications 3
	Custom	20 V (-1.00000 V to 20.40000 V) Measuring range: 30 mΩ/300 mΩ/3 Ω Measurement current: 150 mA/50 mA/5 mA	Custom specifications 4	Custom specifications 5

Custom-made options

4-TERMINAL PROBE L2000
Cable length 1 m (3.28 ft)

Custom-made SET options

BNC-Banana Plug Transducer

PIN TYPE PROBE 9770, 9771, 9772
Cable length 0.85 m (2.8 ft)

Probe tip shape

9770: 9mm, φ1.8mm, 2mm, φ0.6mm
9771: 9mm, 2.2mm, 0.2mm
9772: 9.15mm, 2.5mm, φ1.8mm, 4.5mm

Measure electrochemical parts and materials



For property evaluation of electrodes and electrolyte

Model : CHEMICAL IMPEDANCE ANALYZER IM3590

Model No. (Order Code)

IM3590

Measurement range : 100 mΩ to 100 MΩ
Measurement frequency : 1 mHz to 200 kHz

Note: Company names and Product names appearing in this catalog are trademarks or registered trademarks of various companies.

HIOKI
HIOKI E. E. CORPORATION

HEADQUARTERS
81 Koizumi
Ueda, Nagano 386-1192 Japan
www.hioki.com

HIOKI USA CORPORATION
TEL +1-609-409-9109 FAX +1-609-409-9108
hioki@hiokiusa.com / www.hiokiusa.com

HIOKI (Shanghai) SALES & TRADING CO., LTD.
TEL +86-21-6391-0090/0092 FAX +86-21-6391-0360
info@hioki.com.cn / www.hioki.cn

HIOKI SINGAPORE PTE.LTD.
TEL +65-6634-7677 FAX +65-6634-7477
info-sg@hioki.com.sg / www.hioki.com.sg

HIOKI KOREA CO., LTD.
TEL +82-2-2183-8847 FAX +82-2-2183-3360
info-kr@hioki.co.jp / www.hiokikorea.com

HIOKI EUROPE GmbH
TEL +49-6173-31856-0 FAX +49-6173-31856-25
hioki@hioki.eu / www.hioki.com

HIOKI TAIWAN CO., LTD.
TEL +886-3-3467160 FAX +886-3-3467162
info-tw@hioki.com.tw / www.hioki.com

DISTRIBUTED BY