

Even Speedier Diagnosis of the Deterioration of Lead-acid Batteries

Measure and save data in as fast as 2 seconds, a 60% improvement from the legacy 3554
Easily create reports on your tablet or smartphone



Powerful performance at the job site

New protector delivers better ergonomic hold and durability in the field.

Use Noise Reduction Technology to Reliably Measure UPS Operation

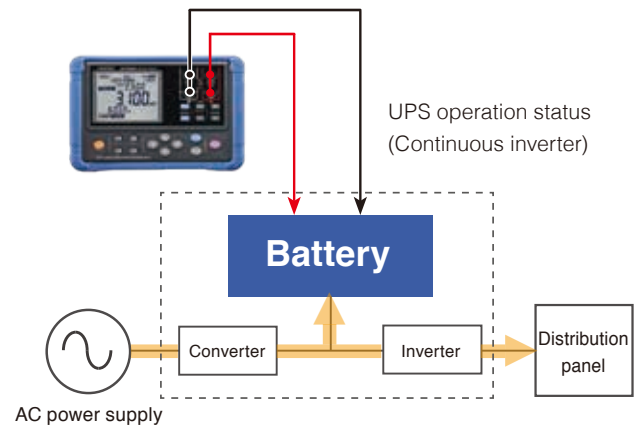

Please see www.hioki.com for list of supported regions.
For BT3554-01 and BT3554-11

Improved Noise Resistance

Comparison of superimposed noise

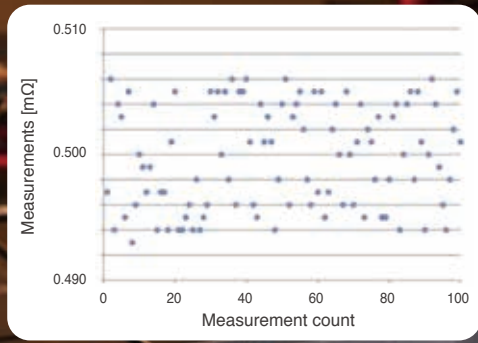

Without noise reduction technology

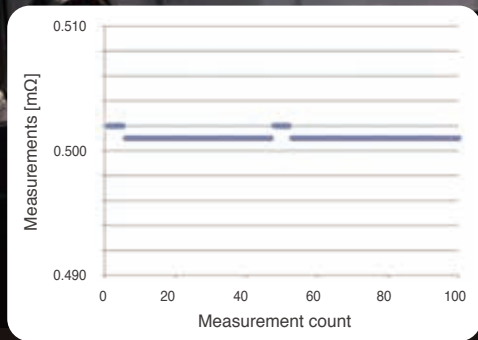

With noise reduction technology



Backlight display that's easy to read, even in dim locations

Use the New Test Lead for the Back of Distribution Panels and Other Hard-to-reach Places

The innovative L-shape design makes it easier to connect the test lead to electrode terminals, decreasing time spent measuring batteries.



Test Leads to Fit your Application

PIN TYPE LEAD L2020



TIP PIN 9465-90
(For the L2020, 9465-10)



A: 70 mm (2.76 in) (Red), 150 mm (5.91 in) (Black, up to 630 mm (24.8 in))
B: 164 mm (6.46 in), L: 1941 mm (76.42 in) (Red)

PIN TYPE LEAD 9465-10 (Bundled accessory)



TIP PIN 9465-90
(For the L2020, 9465-10)



A: 45 mm (1.77 in) (Red), 105 mm (4.13 in) (Black, up to 515 mm (20.28 in))
B: 176 mm (6.93 in), L: 1883 mm (74.13 in) (Red)

PIN TYPE LEAD 9772



TIP PIN 9772-90
(For the 9772)



A: 45 mm (1.77 in) (Red), 105 mm (4.13 in) (Black, up to 515 mm (20.28 in))
B: 173 mm (6.81 in), L: 1880 mm (74.02 in) (Red)

REMOTE CONTROL SWITCH 9466



Press the key to hold or save the measurement.
Cable length: Approx. 2 m

CLIP TYPE LEAD WITH TEMPERATURE SENSOR 9460

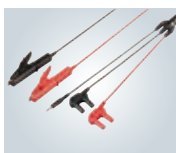

A: 300 mm (11.81 in)
B: 106 mm (4.17 in)
L: 2268 mm (7.44 ft)

LARGE CLIP TYPE LEAD 9467



A: 300 mm (11.81 in)
B: 116 mm (4.57 in)
L: 1360 mm (4.46 in)
Large clip diameter:
Approx. \varnothing 29 mm (1.14 in)

Regarding probe length

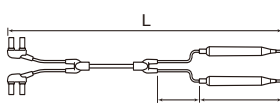

A: Between split to probe, B: Probe length, L: Total length

0 ADJ BOARD Z5038

For the L2020, L9465-10, and 9772

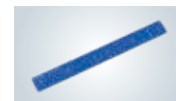

Use commercially available hook-and-loop fasteners when securing to the carrying case.

FUSE SET Z5050

For the BT3554



Replacement fuse set (5 pieces)

Quickly Save Data and Create Reports Right in the Field

Just connect the test lead to the terminal

Easily save data

Connect to the voltage terminal and measure



When the measured value stabilizes, save it automatically without having to operate the switch. Wait time can be as short as only 2 seconds to auto-save from when the test leads make contact with the battery terminals, **cutting time by 60%** compared to the legacy product.

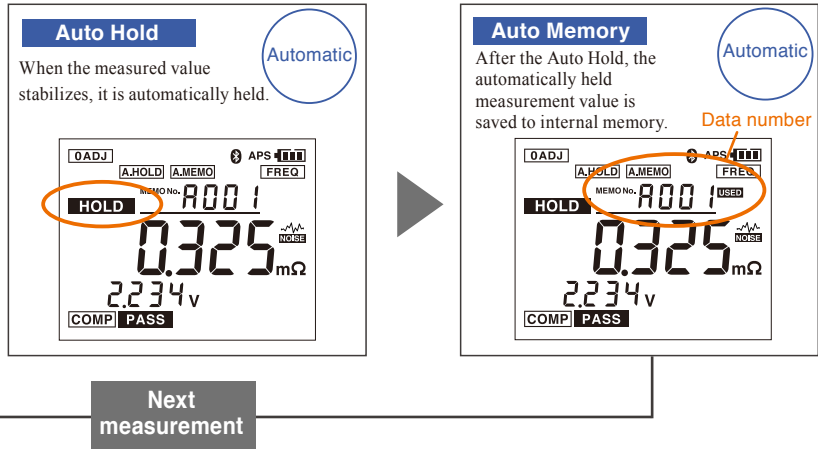

Instantly submit loaded data

Create reports on-site

Data transfer

Dedicated application available

In addition to viewing measurement data downloaded from the BT3554-01 or BT3554-11 in a tabular format on a tablet, smartphone, or PC, you can graph data to assess conditions on a cubicle-by-cubicle basis (up to 500 values). Then, instantly create reports on-site.

Transfer the data saved in the BT3554's internal memory to your tablet or PC via USB/Bluetooth®

Supported models: BT3554-01, BT3554-11

Graph display

Report display



How to download the application:

- Tablet or smartphone
Download it from the App Store® for iPhone® or iPad®, or download it from the Google Play™ Store for Android™ devices. Just search for "GENNECT Cross".

- Data can be downloaded to tablets and smartphones using Hioki's dedicated apps available from the Google Play or App Store. Search for "HIOKI" and download the "GENNECT Cross" app.



*Android, Google Play and the Google Play logo are trademarks of Google Inc.
*iOS is a registered trademark of Cisco Technology, Inc. and/or its affiliates in the United States and certain other countries.
*iPhone, iPad, iPad mini, iPad Pro and iPod touch are trademarks of Apple Inc.
*Apple and the Apple logo are trademarks of Apple Inc. App Store is a service mark of Apple Inc.
*Microsoft, Windows, Windows Vista, and Excel are either registered trademarks or trademarks of Microsoft Corporation in the United States and/or other countries.
*Company names and Product names appearing in this catalog are trademarks or registered trademarks of various companies.
*The Bluetooth® word mark and logos are registered trademarks owned by Bluetooth SIG, Inc. and any use of such marks by HIOKI E.E. CORPORATION is under license.
*For the latest information about countries and regions where wireless operation is currently supported, please visit the Hioki website.

- PC
Bundled CD-R, Download from our homepage.

Interface specifications

USB	Transmission speed: USB 2.0, Connector: USB mini-B
Bluetooth® (BT3554-01 only)	Bluetooth® 4.0LE
	Transmission distance: Approx. 10 m (32.81 ft), line-of-sight
	Supported OS: Android™ 4.3 or later, iOS 10 or later
	Supported Android™ devices: Bluetooth® low energy enabled devices Supported iOS devices: Bluetooth® low energy enabled devices

Trend display for past data*

Analyze in the office

Graphically display the trend of one cubical (max. 500 batteries) or the condition of selected batteries.

[Example of data displayed for selected batteries]

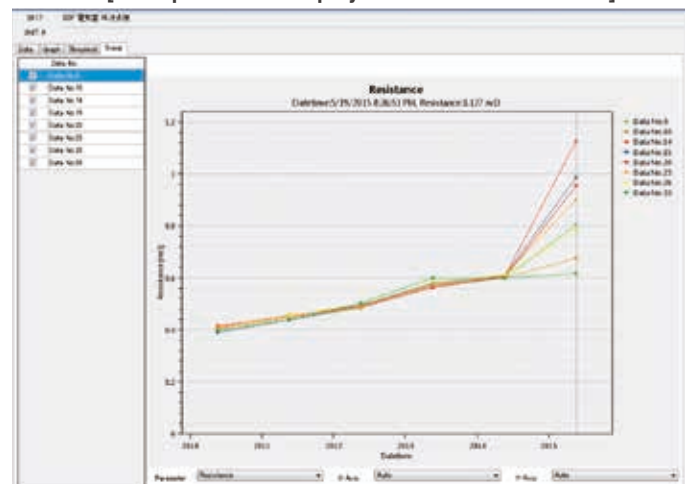

*Trend display is only available with a PC application.

Model: BATTERY TESTER BT3554

Model No. (Order Code)	Built in Bluetooth® Wireless technology	Standard leads
BT3554	—	9465-10
BT3554-10	—	L2020

Model: BATTERY TESTER BT3554-01

Model No. (Order Code)	Built in Bluetooth® Wireless technology	Standard leads
BT3554-01	✓	9465-10
BT3554-11	✓	L2020

Accuracy specifications

Accuracy guaranteed for 1 year, Post-adjustment accuracy guaranteed for 1 year

Temperature and humidity for guaranteed accuracy: 23°C ±5°C (73°F ±9°F), 80% RH or less, Warm-up time: None (Unnecessary), after zero-adjustment

Resistance measurement accuracy

Measurement current frequency: 1 kHz ±30 Hz, With function for avoiding noise frequency enabled: 1 kHz ±80 Hz

Measurement current accuracy: ±10%

Range	Max. display	Resolution	Measurement accuracy	Measurement Current
3 mΩ	3.100 mΩ	1 μΩ	±1.0% rdg. ±8 dgt.*	160 mA
30 mΩ	31.00 mΩ	10 μΩ	±0.8% rdg. ±6 dgt.	160 mA
300 mΩ	310.0 mΩ	100 μΩ		16 mA
3 Ω	3.100 Ω	1 mΩ		1.6 mA

* If zero-adjustment was not performed, add the following values:

When model L2020 is used: ±5 dgt. / When model 9465-10 is used: ±6 dgt.

When model 9772 is used: ±1 dgt. / When model 9460 is used: ±16 dgt.

When model 9467 is used: ±5 dgt.

When using test leads that are not listed above, or test leads whose length has been extended, accuracy is guaranteed only after zero-adjustment is performed.

Voltage measurement accuracy

Range	Max. display	Resolution	Measurement accuracy
6 V	±6.000 V	1 mV	±0.08% rdg. ±6 dgt.
60 V	±60.00 V	10 mV	

Temperature measurement accuracy

Measurement range	Max. display	Resolution	Measurement accuracy
-10 to 60°C	60°C	0.1°C	±1.0°C

Comparator function

Compares setting values (Resistance: 2 levels, Voltage: 1 level) and measured values

Determination method: Following chart, beeping sound, red backlight lights up with beeping sound

Savable settings: 200 tables

		Value for warning		Value for failure	
		Resistance (low)	Resistance (medium)	Resistance (high)	
Value for warning	Voltage (high)	PASS	WARNING	FAIL	
	Voltage (low)	WARNING	WARNING	FAIL	

The Advantages of 4-Terminal Measurement The Quality of Your Test Lead CAN Make a Difference

-Explanation-

When measuring certain batteries such as lead-acid cells, the resulting measurement value may differ depending on the test leads used to conduct the measurement. This difference is due to the shape of the probe tip as well as the dimensions of the 4-terminal test leads used for measurement. However, despite a difference in value given by different test leads, it is safe to assume that each specific value reflects the correct value obtainable by the respective test leads.

Based on this principle, when diagnosing battery deterioration in a time series, it is particularly important to use test leads having the same tip shape and dimensions in order to maintain measurement consistency.

The difference in the measurement values obtained by different test leads is a physical phenomenon caused by the difference in distance between the SOURCE and SENSE pins of the test leads. This is more significant when the battery terminal contains a resistance higher than the internal resistance of the battery under test.

The figure on the right demonstrates how even minute physical differences between the SOURCE and SENSE pins for two types of test leads can affect the detected voltage level of the battery.

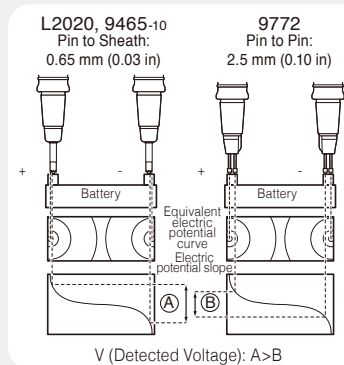

*The Bluetooth® word mark and logos are registered trademarks owned by Bluetooth SIG, Inc. and any use of such marks by HIOKI E.E. CORPORATION is under license.
Note: Company names and Product names appearing in this catalog are trademarks or registered trademarks of various companies.

HIOKI
HIOKI E. E. CORPORATION

HEADQUARTERS

81 Koizumi,
Ueda, Nagano 386-1192 Japan
<https://www.hioki.com/>



Our regional
contact
information

DISTRIBUTED BY

asita
TECNOLOGIE DI MISURA



www.sita.com

General specifications

Measurement types	Internal resistance measurement for batteries (AC four-terminal method) Terminal voltage measurement for batteries (DC voltage) Temperature measurement (when using the 9460)	
Display update rate	Approx. 3 times/s	
Absolute maximum input voltage	±60 V DC max (No AC input allowed)	
Operating environment	Indoors, pollution degree 2, altitude up to 2000 m (6562 ft)	
Operating temperature and humidity	0°C to 40°C (32°F to 104°F), 80% RH or less (no condensation)	
Storage temperature and humidity	-10°C to 50°C (14°F to 122°F), 80% RH or less (no condensation)	
Power supply	AA (LR6) Alkaline Batteries x 8	
Continuous operating time	Approx. 8.5 hours (When using alkaline batteries)	
Auto power save	Auto power off after 10 minutes unless during data transmission	
Dielectric strength	1.5 kV AC for 1 minute, between all measurement terminals and the USB terminal	
Applicable standards	Safety	EN 61010
	EMC	EN 61326
Dimensions	Approx. 192 mm (7.56 in) W x 121 mm (4.76 in) H x 55 mm (2.17 in) D, With protector attached	
Mass	BT3554, BT3554-10: Approx. 790 g (27.9 oz) (Including batteries and protector)	
	BT3554-01, BT3554-11: Approx. 800 g (28.2 oz) (Including batteries and protector)	
Accessories	PIN TYPE LEAD 9465-10 (Bundled with BT3554, BT3554-01), PIN TYPE LEAD L2020 (Bundled with BT3554-10, BT3554-11), ZERO ADJUSTMENT BOARD, PC Software Application CD, Power-on option sticker, Neck strap, AA (LR6) alkaline batteries x 8, Fuse, USB cable, Carrying case, Instruction manual, Protector, Cautions for using radio waves (BT3554-01, BT3554-11)	

Functions

HOLD	(1) Hold measured value by pressing the HOLD key or when shorting the EXT. HOLD terminal (2) Automatically hold measured value after it stabilizes
Memory storage	Saving, loading, and deleting measured values Saved items: Date, resistance, voltage, temperature, comparator threshold, judgment Storable data: 6000 sets (500 data sets per unit) Memory structure: 500 data sets per unit (12 units)
Auto-Memory function	Automatically saves measured values to memory when they are held
Memory loading	Load stored data on instrument or with PC application in order

*The thresholds for determining the pass/fail condition of a battery depend on the specifications and standards of the battery manufacturer, battery type, capacity, etc. It is important and necessary to always conduct battery testing against the internal resistance and terminal voltage of a new or reference battery.

In some cases, it may be difficult to determine the deterioration state of traditional open type (liquid) lead-acid or alkaline batteries, which demonstrate smaller changes in internal resistance than sealed lead acid batteries.